

# RCS T-series



This page is intentionally left blank.

# Contents

|   |    |
|---|----|
| <b>Legal information</b> . . . . .                              | 5  |
| Warranty . . . . .  | 5  |
| Packing material . . . . .                                      | 5  |
| Renishaw software EULA . . . . .                                | 5  |
| <b>International regulations and conformance</b> . . . . .      | 6  |
| Declaration of conformity . . . . .                             | 6  |
| Disposal of waste electrical and electronic equipment . . . . . | 6  |
| REACH regulation . . . . .                                      | 6  |
| FCC . . . . .   | 7  |
| <b>Supplier’s Declaration of Conformity</b> . . . . .           | 7  |
| 47 CFR § 2.1077 compliance information . . . . .                | 7  |
| US Government notice . . . . .                                  | 7  |
| RoHS compliance . . . . .                                       | 8  |
| China RoHS . . . . .  | 8  |
| ICES-001 (Canada only) . . . . .                                | 8  |
| <b>Safety information</b> . . . . .                             | 8  |
| Overview . . . . .  | 8  |
| Mechanical safety . . . . .                                     | 9  |
| Electrical and power safety . . . . .                           | 10 |
| Metric and imperial accessory kits . . . . .                    | 10 |
| Cleaning the balls . . . . .                                    | 10 |
| Cleaning the joints . . . . .                                   | 11 |
| <b>System overview</b> . . . . .                                | 12 |

|  |    |
|--|----|
| <b>Guidelines for best practice</b> .....        | 13 |
| Using the RCS T-90 system .....                  | 13 |
| Using the RCS T-90 on the tripod .....           | 13 |
| Handling the RCS L-90 ballbar with care .....    | 14 |
| <b>Setting up RCS T-90</b> .....                 | 15 |
| Setting up the RCS T-90 on a fixture plate ..... | 15 |
| Setting up the RCS T-90 using the tripod .....   | 16 |
| System pairing and connecting .....              | 17 |
| <b>RCS product calibration</b> .....             | 18 |
| Calibration certificates .....                   | 18 |
| Certificate content .....                        | 18 |
| RCS L-90 calibration and homing .....            | 19 |
| RCS T-90 ballbar calibration procedure .....     | 19 |
| Using the RCS calibrator with the tripod .....   | 21 |
| RCS T-90 frame calibration .....                 | 23 |
| <b>RCS Software Suite</b> .....                  | 24 |
| Software download .....                          | 24 |
| <b>Complete RCS T-90 system contents</b> .....   | 25 |
| <b>RCS T-90 upgrade kit</b> .....                | 26 |
| <b>RCS T-90 tripod kit</b> .....                 | 27 |
| <b>Interface LED status</b> .....                | 28 |
| <b>Troubleshooting</b> .....                     | 31 |
| Equipment mishandling .....                      | 31 |
| In-test robustness .....                         | 31 |
| <b>Further information</b> .....                 | 31 |

## Legal information

### Warranty

Unless you and Renishaw have agreed and signed a separate written agreement, the equipment and/or software are sold subject to the Renishaw Standard Terms and Conditions supplied with such equipment and/or software, or available on request from your local Renishaw office.

Renishaw warrants its equipment and software for a limited period (as set out in the Standard Terms and Conditions), provided that they are installed and used exactly as defined in associated Renishaw documentation. You should consult these Standard Terms and Conditions to find out the full details of your warranty.

Equipment and/or software purchased by you from a third-party supplier is subject to separate terms and conditions supplied with such equipment and/or software. You should contact your third-party supplier for details. If you purchased the equipment from any other supplier, you should contact them to find out what repairs are covered by their warranty.

### Packing material

| Packaging component | Material                  | 94/62/EC Code | 94/62/EC number |
|---------------------|---------------------------|---------------|-----------------|
| Outer box           | Non-corrugated fibreboard | PAP           | 21              |
| Bag                 | Low density Polyethylene  | LDPE          | 4               |

### Renishaw software EULA

Renishaw software is licensed in accordance with the Renishaw licence at:

[www.renishaw.com/legal/en/software-licence-agreement](http://www.renishaw.com/legal/en/software-licence-agreement)

## International regulations and conformance

### Declaration of conformity



Renishaw plc hereby declares that RCS T-series system complies with the essential requirements and other relevant provisions of:

- the applicable EU directives
- the relevant statutory instruments under UK law

In compliance with BS EN 61010-1:2010 the product is safe to use in the following environmental conditions:

- Indoor use only
- Altitude up to 2000 m
- Maximum relative humidity (non-condensing) of 80% for temperatures up to 31° C, decreasing linearly to 50% relative humidity at 40° C
- Pollution degree 2

The full text of the declaration of conformity is available upon request.

## Disposal of waste electrical and electronic equipment



The use of this symbol on Renishaw products and/or accompanying documentation indicates that the product should not be mixed with general household waste upon disposal. It is the responsibility of the end user to dispose of this product at a designated collection point for waste electrical and electronic equipment (WEEE) to enable reuse or recycling. Correct disposal of this product will help to save valuable resources and prevent potential negative effects on the environment. For more information, contact your local waste disposal service or Renishaw distributor.

### REACH regulation

Information required by Article 33(1) of Regulation (EC) No 1907/2006 (“REACH”) relating to products containing substances of very high concern (SVHCs) is available at:

[www.renishaw.com/REACH](http://www.renishaw.com/REACH)

## FCC

This device complies with part 15 of the FCC Rules. Operation is subject to the following two conditions:

1. This device may not cause harmful interference, and
2. This device must accept any interference received, including interference that may cause undesired operation.

The user is cautioned that any changes or modifications not expressly approved by Renishaw plc or authorised representative could void the user's authority to operate the equipment.

This equipment has been tested and found to comply with the limits for a Class A digital device, pursuant to Part 15 of the FCC rules. These limits are designed to provide reasonable protection against harmful interference when the equipment is operated in a commercial environment. This equipment generates, uses and can radiate radio frequency energy and, if not used in accordance with this user guide, may cause harmful interference to radio communications. Operation of this equipment in a residential area is likely to cause harmful interference, in which case you will be required to correct the interference at your own expense.

## Supplier's Declaration of Conformity

### 47 CFR § 2.1077 compliance information

**Unique Identifier: RCS L-90 and RCS T-90 systems**

**Responsible Party – U.S. Contact Information**

Renishaw Inc.

1001 Wesemann Drive

West Dundee

Illinois

IL 60118

United States

Telephone number: +1 847 286 9953

Email: [usa@renishaw.com](mailto:usa@renishaw.com)

### US Government notice

NOTICE TO UNITED STATES GOVERNMENT CONTRACT AND PRIME CONTRACT CUSTOMERS.

This software is commercial computer software that has been developed by Renishaw exclusively at private expense. Notwithstanding any other lease or licence agreement that may pertain to, or accompany the delivery of, this computer software, the rights of the United States Government and/or its prime contractors regarding its use, reproduction and disclosure are as set forth in the terms of the contract or subcontract between Renishaw and the United States Government, civilian federal agency or prime contractor respectively. Please consult the applicable contract or subcontract and the software licence incorporated therein, if applicable, to determine your exact rights regarding use, reproduction and/or disclosure.

## RoHS compliance

Compliant with EC directive 2011/65/EU (RoHS)

## China RoHS

The T-90 China RoHS is available on request. Please contact Renishaw plc support for the full China RoHS tabulation.



## ICES-001 (Canada only)

This ISM device complies with Canadian ICES-001(A) / NMB-001(A).

Cet appareil ISM est conforme à la norme ICES-001(A) / NMB-001(A) du Canada.

## Safety information

### Overview

The RCS T-series system can be used in a variety of environments and applications.

---

**WARNING:** To ensure the safety of the user and other personnel in the vicinity, it is recommended that a comprehensive risk assessment of the robot system under test is carried out before starting.

---

The risk assessment should be carried out by qualified users (requiring machine competency, application technical knowledge and advice from a trained risk assessor) with consideration for the safety of all personnel. The risks identified must be mitigated prior to using the systems. The risk assessment should pay particular attention to robot system movement (in both manual and automatic modes), manual handling, and electrical safety.

---

**CAUTION:** There are no user-serviceable parts inside the RCS T-series robot ballbar system and T-series interface modules. Do not remove any part of the housing; to do so could cause personal harm and damage the system irreparably.

---



Ensure that you have read and fully understood the RCS L-series and T-series user guides before using the devices.

---

**NOTE:** Appropriate safety wear must be worn during installation and operation of the product within a robotic cell.

---



**CAUTION:** The system contains magnets which may cause pinch injuries with metal objects or interfere with electronic and implanted medical devices.

---

## Mechanical safety

- When setting up and mounting the RCS T-series, be aware of pinch and/or crush hazards that may be created, for example, due to magnetic coupling and/or the expanding or collapsing of the robot ballbar.
- Be aware of trip hazards that may be created between the cables of the RCS T-series, interface modules and the laptop or desktop computer.
- Exercise caution if the system is mounted to an external axis that moves or rotates. Beware of cables becoming entangled.
- If operating the robot system with guards or any safety features removed or disabled, it is the responsibility of the operator to ensure that alternative safety measures are taken in line with the operating instructions for the robot system or relevant codes of practice.
- If operating the robot system within a guarded cell, it is the responsibility of the operator to ensure safe practice is followed.
- When setting up the tripod stand, the height of the tripod should be set to approximately the height of the robot fixture plate. The tripod stand legs should be adjusted to ensure that the tripod is steady and will not move during use.

## Electrical and power safety

- It is recommended that contact with fluids; for example, coolant should be avoided where possible.
- The RCS T-series must be powered by the power supply provided.
- Use the correct regional power adaptor for your system.
- The RCS T-series interface box is compatible with any USB 2.0 port (and above) on a laptop or desktop computer. The USB power source is not sufficient to power the system.
- Never connect the interface modules to devices that are not intended to be used as part of the RCS T-series.

## Metric and imperial accessory kits

Both metric and imperial versions of the accessory kits are available. The measurement unit is detailed in the product names. The complete kit is supplied as standard with metric mounting screws. Check that you have the correct accessories before set-up.

## Cleaning the balls

Prior to use, check all datum balls are clean and undamaged. Where required, use the supplied Renishaw cleaning kit to ensure that end joints are clean and free from debris.

Primary cleaning should be undertaken with a dry, lint free cloth. Isopropyl alcohol (IPA) can be used for any stubborn grime and debris.

---

**NOTE:** Check datum balls regularly for imperfections. For details of replacement kits, contact your local Renishaw representative.

---

## Cleaning the joints

Prior to mounting the system, ensure all contact points and extensions are free from debris (for example, metal shavings on either magnetic mounting interface) using the Renishaw-supplied cleaning kit.

With clean hands, tear off a small piece of material and shape it into a ball.

Press into or onto each feature, taking care to ensure none of the cleaning material is left behind.



## System overview

The RCS T-series is a tripod ballbar system designed to enable advanced tests to be undertaken for the calibration of robot systems, periodic health checks and preventative maintenance. The system can be used to calibrate joint offsets and tool centre points, and to record path accuracy.

The RCS T-90 is a tripod configuration of three RCS L-90 ballbars magnetically seated across the RCS baseplate. As the robot manipulator moves through test positions, the system records accurate measurements which are then used by the RCS Software Suite to output a result.

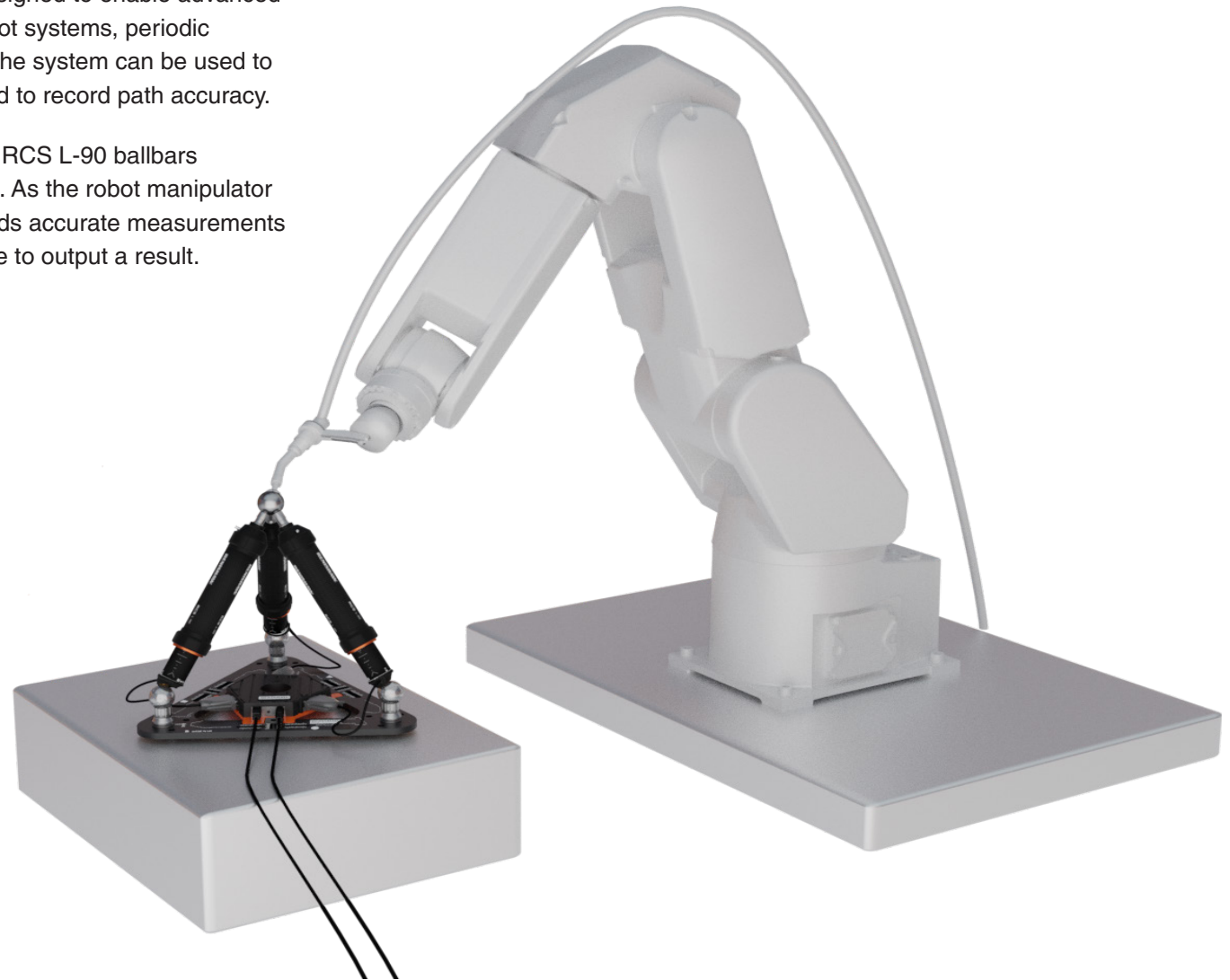

## Guidelines for best practice

### Using the RCS T-90 system

- The RCS T-series has been designed to be robust; however, the equipment is a precision measurement system and must be handled with care.
- When mounting the devices, ensure all contact points and balls are free from debris (for example, metal shavings on either magnetic mounting interface), using the provided Renishaw cleaning kit. Ensure the RCS T-series extensions are aligned correctly and are used as intended.
- Calibrating each RCS L-90 ballbar, which forms part of the RCS T-90 system, is recommended to be undertaken regularly using the supplied calibrator. Refer to page 15 for more information on when calibration should take place. The RCS T-90 baseplate is recommended to be calibrated at the start of every test within the RCS Software Suite.
- Ensure that the datum balls are clean and not damaged before use. For information on cleaning the balls and joints please refer to page 10 and page 11.
- When setting up the system, care and consideration should be given to the placement and orientation of products. Check that all items are secured and are not likely to move during use.
- Do not disconnect the power supply whilst the system is in use.
- When plugging in each RCS L-90 to the T interface box, ensure that the D-type connections are firmly fixed in place using the screw pins.

- Two RCS L-90 ballbars are used during parts of the joint offset test. During this test, the unused ballbar should be left in the ball-to-ball position.
- Once paired, the supplied cable tag identifiers with the unique symbols should be added to each RCS L-90 ballbar cable so that they can be easily reconnected to the correct interface ports.

### Using the RCS T-90 on the tripod

For best results, mount the RCS T-90 system to a normal fixture plate within the robot working volume. However, there may be times when the system needs to be mounted and operated from a tripod set-up.

Ensure all cables are routed in a way that avoids potential trip hazards.

## Handling the RCS L-90 ballbar with care

The RCS T-series has been designed to be robust; however, the equipment is a precision measurement system and must be handled with care. The RCS T-90 system uses three RCS L-90 ballbars. Each RCS L-90 contains an encoder readhead to deliver accurate measurements.

Rough handling of the ballbar may damage it and cause the encoder to malfunction, leading to the need for re-homing. When handling, ensure the ballbar is fully closed wherever possible.

When extending or closing the ballbar, use the thumb tag identified in the image below.



## Setting up RCS T-90

### Setting up the RCS T-90 on a fixture plate

Fix the baseplate to a flat surface within the working area of the robot, using a single screw through the interface centre.

It is recommended to use a torque wrench to tighten the centre screw to 5.1 Nm.

Connect the RCS L-90 ballbars to the RCS T interface box by matching the identifier shapes together. See page 17 for further information.

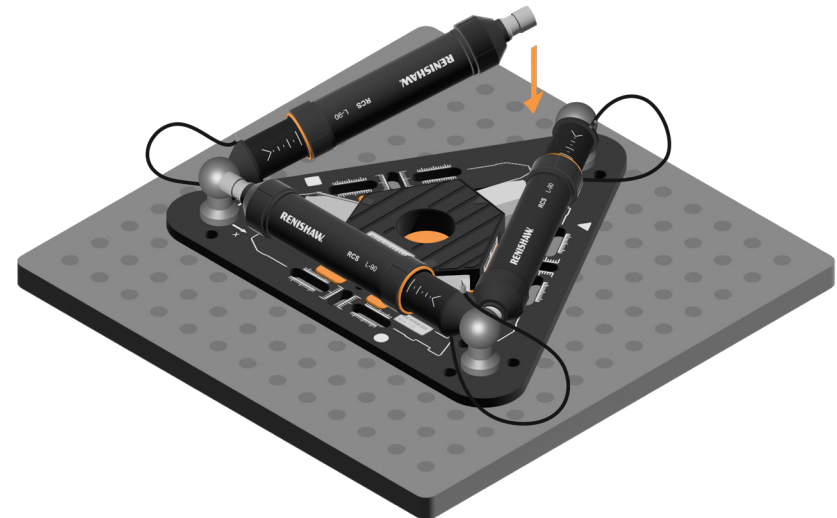
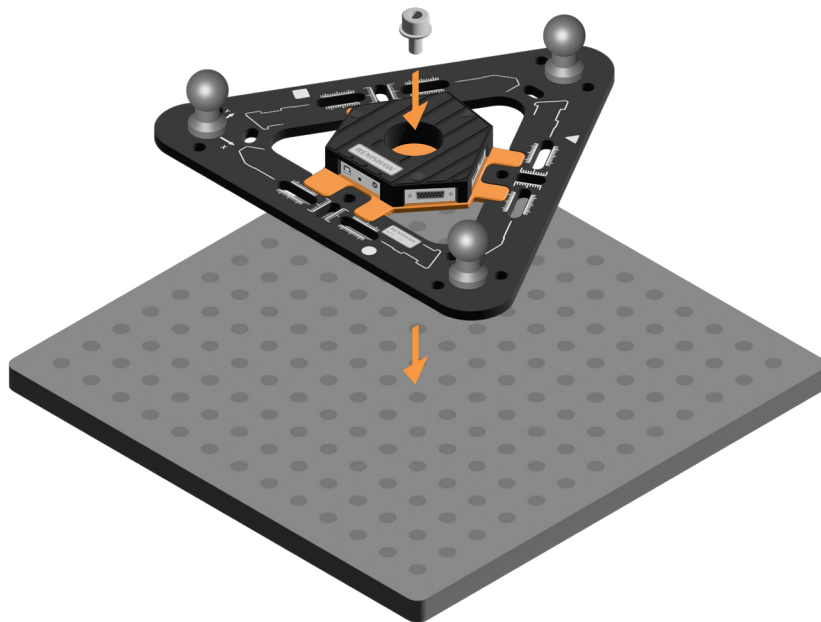

---

**NOTE:** Any of the other holes on the baseplate can be used to ensure it is fixed securely.

---

## Setting up the RCS T-90 using the tripod

The tripod provides a stable mounting for the RCS L-90 and RCS T-90 whilst allowing the height to be adjusted.

Fix the baseplate to the tripod adaptor plate using the three screw holes pictured.

Connect the RCS L-90 ballbars to the RCS T interface box by matching the identifier shapes together. See page 17 for further information.

---

**NOTE:** Ensure all cables are routed in a way that avoids potential trip hazards.

---





## System pairing and connecting

1. Connect all three RCS L-90 ballbars to the RCS T interface box.
2. Each port on the interface box is marked with a unique identifier shape. After pairing an RCS L-90 to an interface port for the first time, attach the matching shape sticker to the ballbar cable. For all future use, ballbars must be connected to the same paired input.
3. Connect the RCS L-90 ballbars between the fixed baseplate balls. Match the direction of the ballbars to the ballbar markings on the baseplate.

---

**NOTE:** Always check before use that the RCS L-90 cable sticker matches the shape on the interface port.

---

4. Once connected, click the **RCST-90** icon at the bottom right of the RCS Software Suite. Press the **pair** button and follow the steps to pair the ballbars. The software will then move on to the calibration screen.

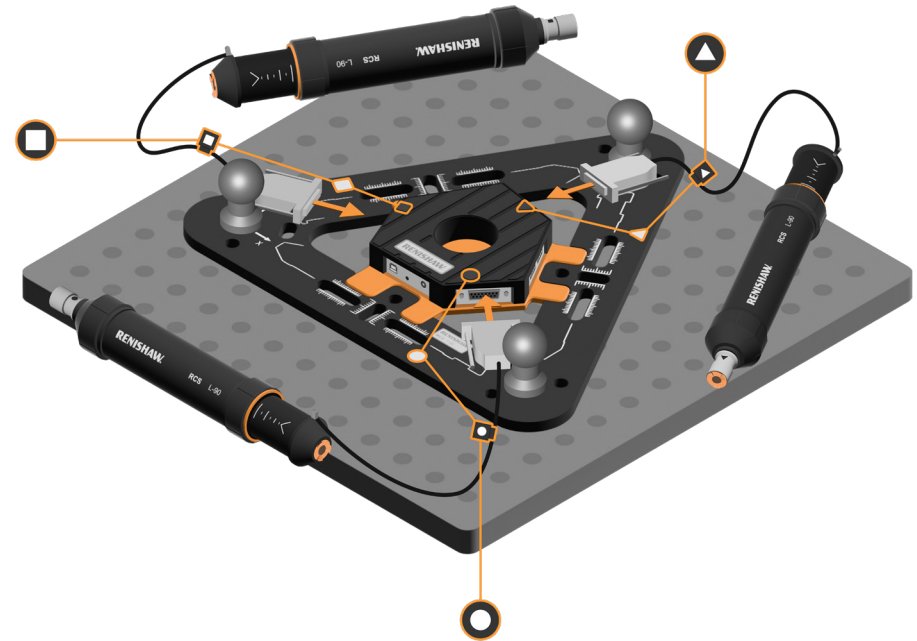

## RCS product calibration

### Calibration certificates

Each RCS L-90 ballbar and calibrator is delivered with a calibration certificate. This demonstrates that the system has been calibrated at the Renishaw factory with traceability to national standards. It is proof of the equipment's performance as tested prior to delivery. Visit the **Calibration product quality and conformance** webpage ([www.renishaw.com/en/calibration-product-quality-and-conformance--6872](http://www.renishaw.com/en/calibration-product-quality-and-conformance--6872)) for more information.

The certificates are important documents which may be required to demonstrate compliance with quality assurance requirements.

Replacement documents can be purchased. Contact Renishaw support for more information.



### Certificate content

Each certificate is unique and is identified by a certificate number. All RCS calibration certificates provide the following key information:

- Serial number of calibrated RCS product
- Specific test results
- Statement of accuracy
- Traceability data (calibration details)
- Test conditions and methodology

To enable traceability, details of the test equipment used are given. The date of testing and the date of printing the certificate are separately noted and the results are signed by an authorised Renishaw employee.

Details of the test procedure, test environment, and applicable standards, all in accordance with the requirements of Renishaw's ISO 9001 quality assurance system, are also supplied.

## RCS L-90 calibration and homing

Calibration of the RCS L-series system should be completed with the supplied calibrator.

For best results, calibrate the RCS L-90 ballbars using the supplied calibrator regularly and following any notable changes:

- Once every 12 hours
- Before first use in each new location
- After any notable change in the room temperature (greater than  $\pm 5^\circ \text{C}$ )

---

**CAUTION:** Handle the calibrator with care. Whilst the unit is built to be robust and to be used when calibrating the system, it is a high accuracy device and should be handled accordingly.

---

The RCS L-90 ballbar is automatically homed when it passes over a reference mark.



## RCS T-90 ballbar calibration procedure

Once the RCS L-90 ballbars have been paired, the RCS Software Suite will prompt you to calibrate each ballbar.

The RCS T-90 kit includes three ballbar extensions. The extensions are marked with the same unique identifier shapes as the T interface box ports and cable stickers (see page 17).

For use within the RCS T-90 system, calibrate each ballbar before and after you have fitted its matching extension. The RCS Software Suite will guide you through the calibration steps.

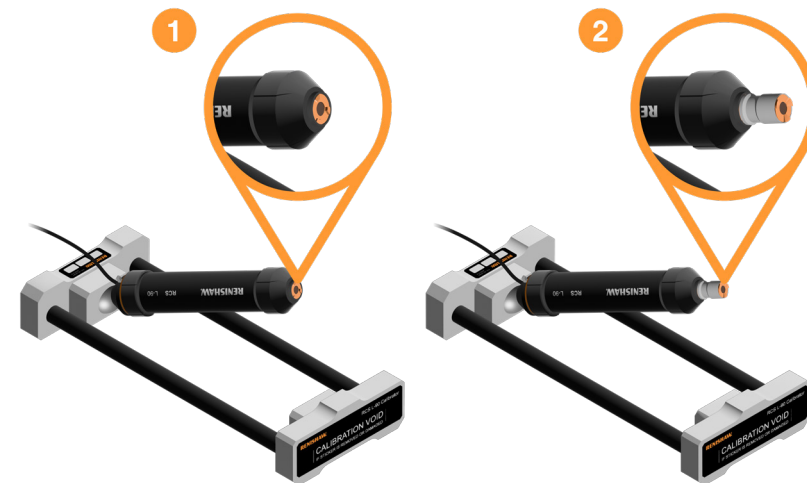

The instructions below ensure best practice is followed when fitting each of the three RCS L-90 ballbars (which make up the RCS T-90).

1. With the RCS L-90 ballbar closed, carefully attach the cabled end of the RCS L-90 ballbar to one end of the calibrator.

---

**NOTE:** When calibrating for the RCS T-90 system, each of the RCS L-90 ballbars must be calibrated an additional time with the extensions attached. Please refer to the RCS Software Suite for guidance.

---



2. Extend the ballbar so that the opposite end reaches the opposite ball surface of the calibrator. Ensure the RCS L-90 ballbar is magnetically attached to the calibrator.



3. For removal, the process must be reversed. Close the ballbar by retracting the 'non-cable end', before removing from the calibrator.



---

**NOTE:** To calibrate an RCS L-90 for single ballbar use, refer to the RCS L-90 user guide for the calibration steps.

---

## Using the RCS calibrator with the tripod

1. Place the brackets on to the frame, ensuring the holes line up.



2. Fix the bracket in place using the two thumb screws.



3. Place the calibrator into the brackets.

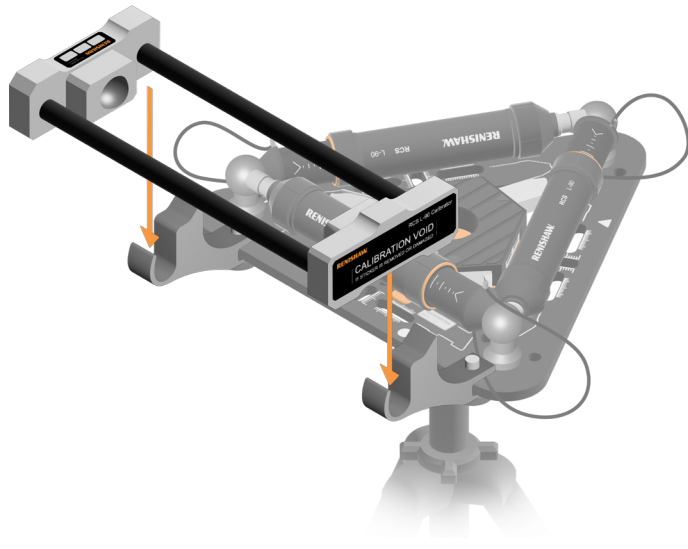

4. Rotate the calibrator to the upright position.

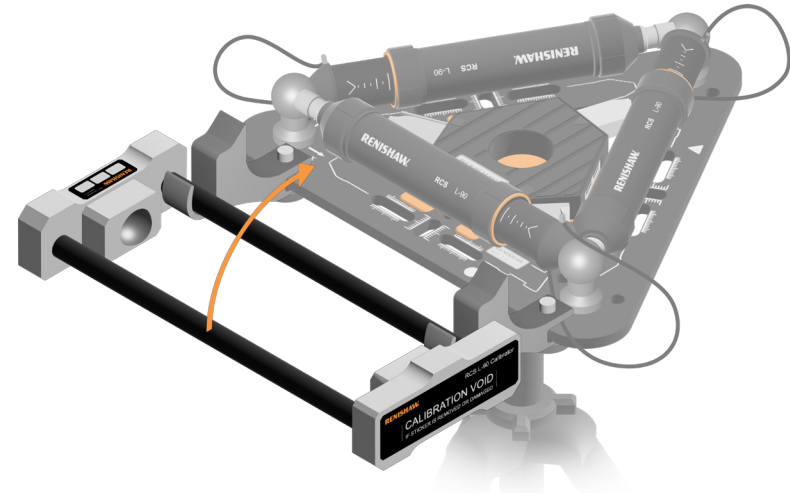

5. Tilt the calibrator towards the baseplate until it is stopped by the brackets. This prevents the calibrator from rolling backwards.

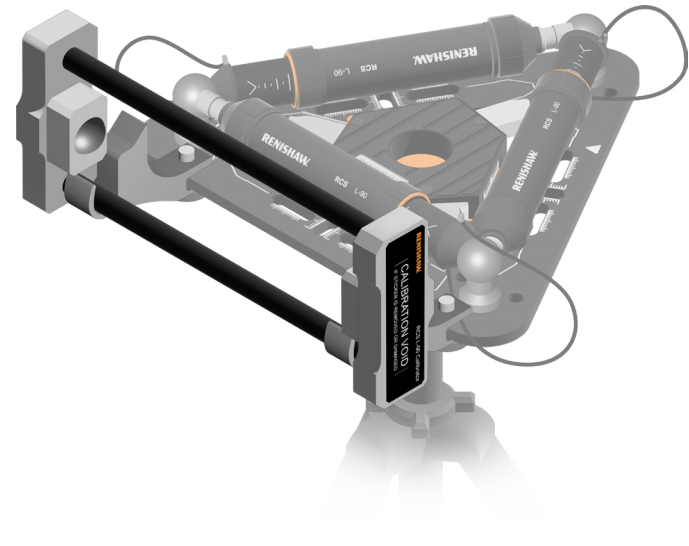

6. With the calibrator in position, follow the steps in RCS Software Suite to calibrate the ballbars with and without extensions (see page 19).



7. Remove the calibrator before moving your robot again.

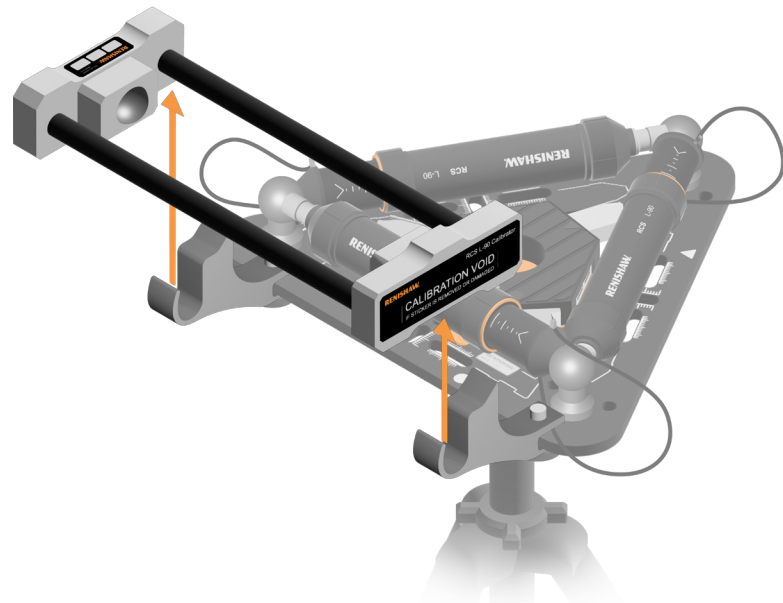

8. Remove the brackets before moving your robot again.

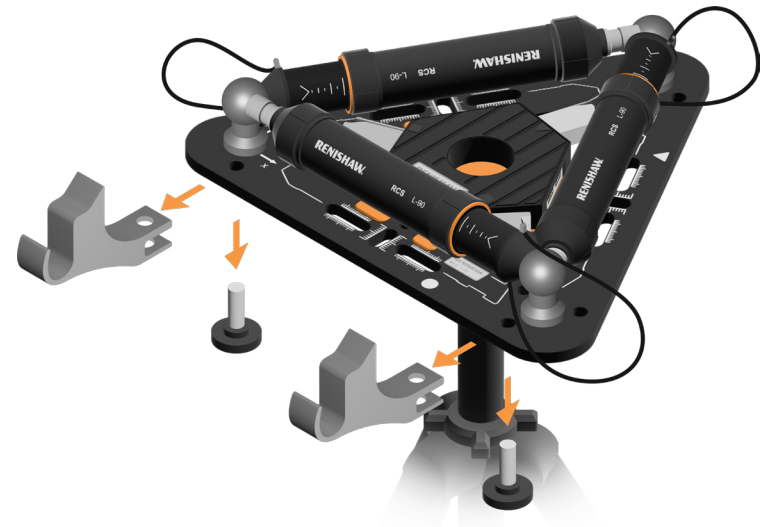

## RCS T-90 frame calibration

The RCS T-90 baseplate calibration must be performed prior to any test.

To calibrate the baseplate, follow the steps in RCS Software Suite.



# RCS Software Suite

## Software download

### Activating a software licence

If you have purchased a software subscription, you will receive an email containing your unique licence details from Renishaw Licensing (**licensing@renishaw.com**). This email contains your 'Entitlement ID' which is required for the licence activation process.

## Software download

Visit <https://www.renishaw.com/softwarelicensing>

If you already have a MyRenishaw account, select the 'Sign in' option. It is important that this step is undertaken first.

1. If you do not have a MyRenishaw account, select 'Need an account?'.
2. Scroll down to 'Robotics' and download the RCS Software Suite.
3. For more information on licensing, visit **Licensing user guides (www.renishaw.com)**.

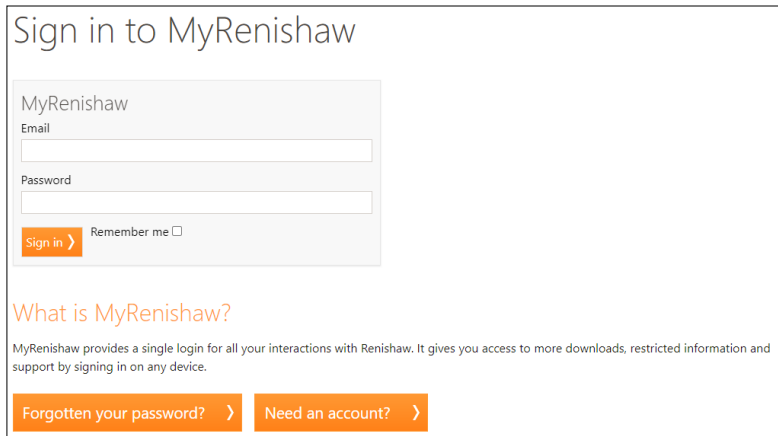

The screenshot shows the 'Sign in to MyRenishaw' page. It features a login form with fields for 'Email' and 'Password'. Below the password field is a 'Remember me' checkbox and a 'Sign in' button with a right-pointing arrow. Underneath the form is a section titled 'What is MyRenishaw?' with a brief description: 'MyRenishaw provides a single login for all your interactions with Renishaw. It gives you access to more downloads, restricted information and support by signing in on any device.' At the bottom of the page are two buttons: 'Forgotten your password?' and 'Need an account?', both with right-pointing arrows.



## Complete RCS T-90 system contents

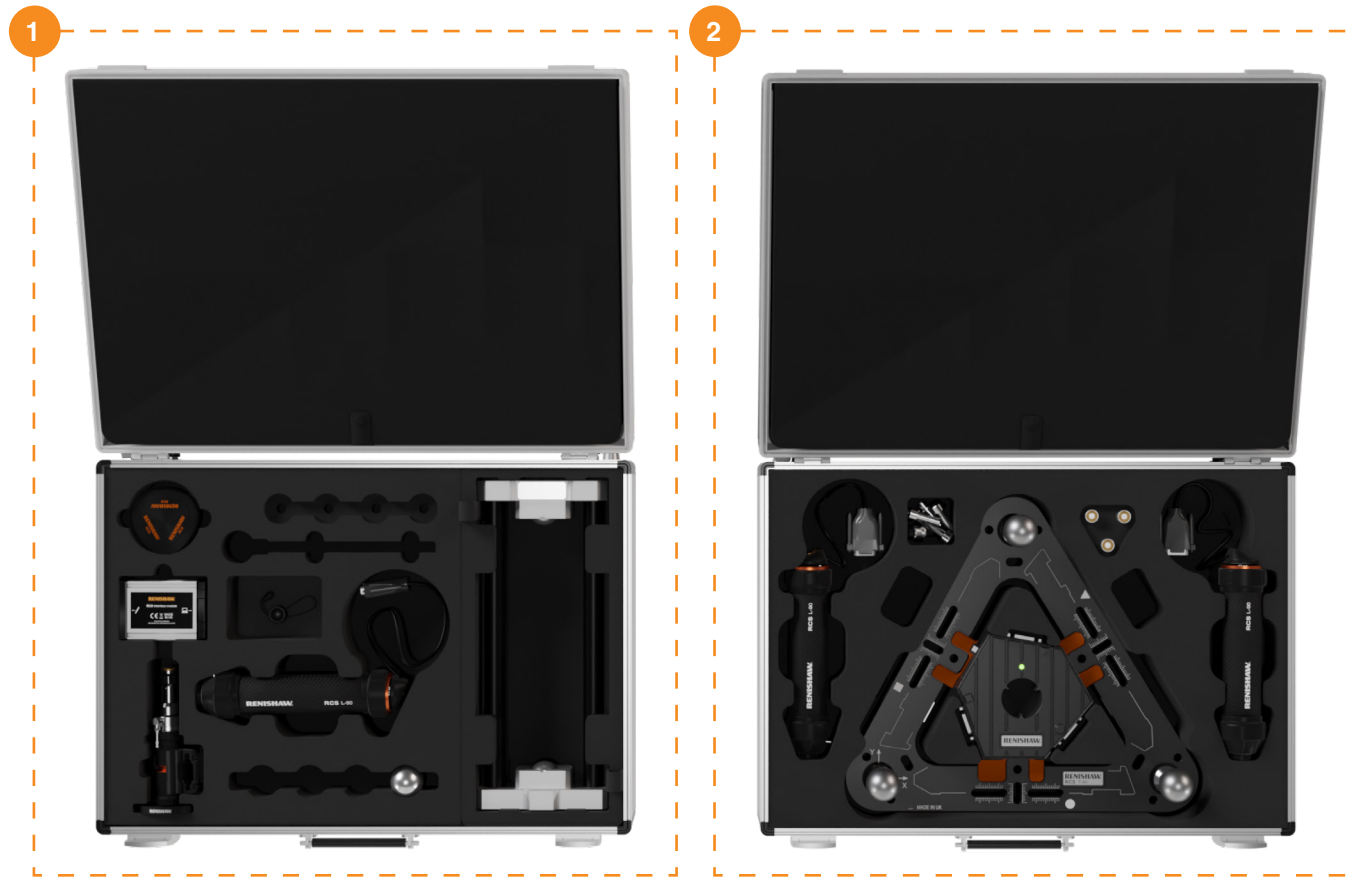

|   | Part number | Part name            |
|---|-------------|----------------------|
| 1 | A-6827-6100 | RCS L-90 kit         |
| 2 | A-6828-6100 | RCS T-90 upgrade kit |

**NOTE:** For RCS L-90 kit contents, refer to the RCS L-90 user guide.

# RCS T-90 upgrade kit



|   | Part number | Part name                          |
|---|-------------|------------------------------------|
|   | A-6828-6100 | RCS T-90 upgrade kit               |
| 1 | A-6827-6210 | RCS L-90 ballbar (× 2)             |
| 2 | A-6828-6210 | RCS T-90 baseplate                 |
| 3 | A-6828-6240 | RCS T interface box                |
| 4 | A-6828-6250 | Square T-90 extension              |
|   |             | Circle T-90 extension              |
|   |             | Triangle T-90 extension            |
| 5 | -           | RCS T-90 fixing accessories        |
| 6 | -           | Power supply and regional adaptors |
| 7 | -           | RCS T USB cable                    |
| 8 | -           | RCS T-90 case                      |

**NOTE:** For details of purchasing replacement parts, contact your local Renishaw representative.

## RCS T-90 tripod kit





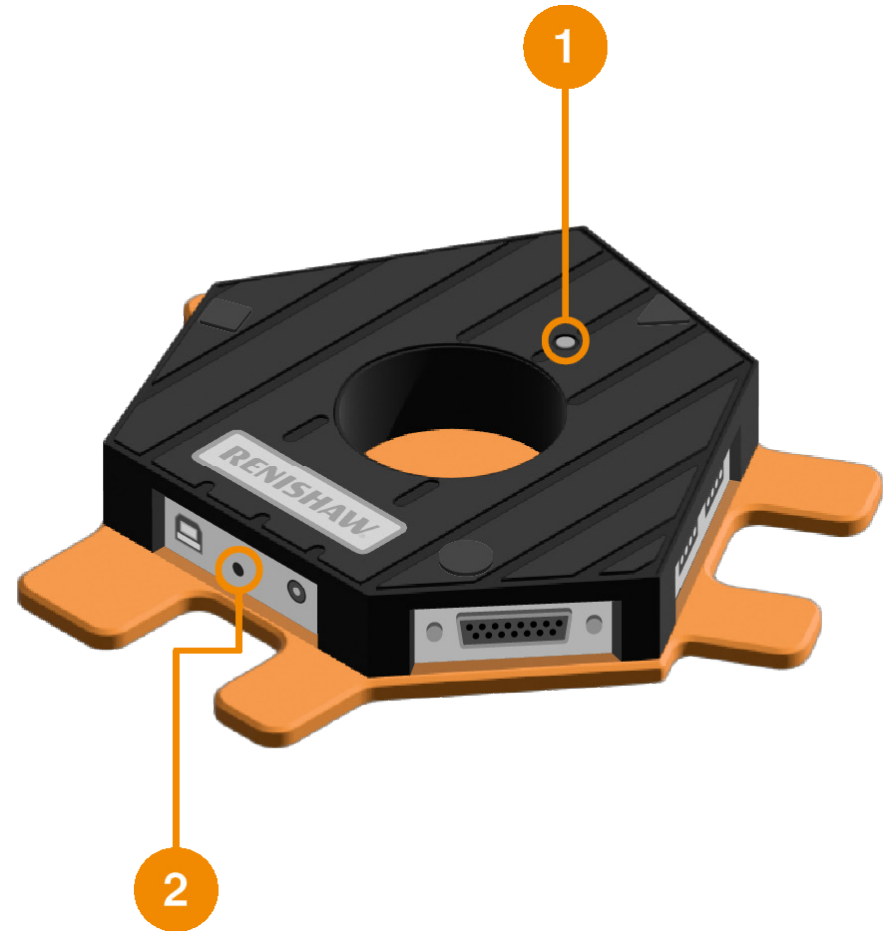

|   | Part number | Part name                           |
|---|-------------|-------------------------------------|
|   | A-6828-6120 | RCS T-90 tripod kit                 |
| 1 | -           | RCS tripod with fixed adaptor plate |
| 2 | M-9908-0527 | Renishaw fabric tripod case         |
| 3 | A-6828-6270 | RCS calibrator bracket set          |

## Interface LED status







Located on the top and side of the RCS T interface box are two LEDs; the top LED (1) indicates the status of the ballbars and the side LED (2) indicates the power and connection status of the interface. See page 29 and page 30 for status/indications:



## 1. Top LED

| LED colour |  | Ballbar status   | Actions   |
|------------|--|--|---|
| Off        |  | Bootloader mode.   | N/A   |
| Off        |  | Application mode started.  | N/A   |
| Red        |   | At least one ballbar is in error (unseated ballbar, detached ballbar, invalid encoder reading, or invalid encoder signal). | Follow the guidelines on the RCS Software Suite to clear the error. |
| Orange     |   | At least one ballbar requires homing (API connected, no errors).   | Extend and collapse the ballbar to find the reference mark.         |
| Blue       |   | Ready (API connected, no error, homed).  | N/A   |
| Green      |   | Streaming.   | N/A   |
| Blink      |  | Received a command from the API.   | N/A   |

## 2. Side LED

| LED colour             |   | Power and connection status              | Actions   |
|------------------------|---|--|---|
| Red                    |  | Bootloader mode.                         | N/A   |
| Flashes 3 colours once |  | Application mode started.                | N/A   |
| Red flashing           |  | USB not connected to PC.                 | Connect the interface box to the computer via the USB cable provided.   |
| Cyan                   |  | USB connected to PC – API not connected. | Start the RCS Software Suite.   |
| Cyan flashing          |  | No activity on the USB.                  | Ensure the RCS Software Suite is connected and running normally, and that the USB cable is not damaged and plugged in fully on both ends. Ensure the RCS L-90 is listed on the device manager (unplug and plug back in the USB cable if necessary). |
| Green                  |  | API connected.                           | N/A   |

## Troubleshooting

### Equipment mishandling

Recalibrate the RCS L-90 if it is dropped or mishandled. Particularly if the end joints are exposed to shock loading.



---

**IMPORTANT:** Recalibrate the RCS L-90 after any automated (robot-driven) compression beyond its minimum length.

---

### In-test robustness

RCS L-90 has been designed to remain in contact with the datum balls during the specified tests.

If the ballbar detaches from the datum balls during the test process, first check to ensure that the datum balls are undamaged and clean. If this does not resolve the issue, consider reducing the acceleration of the robot.

### Further information

For further operational information, refer to the step-by-step guides within the RCS Software Suite. Additional support material is available for download at [www.renishaw.com/rcs-support](http://www.renishaw.com/rcs-support).

If further information is still required please contact the support teams via [www.renishaw.com/contact](http://www.renishaw.com/contact).

[www.renishaw.com/contact](http://www.renishaw.com/contact)

 #renishaw

 **+44 (0) 1453 524524**     **industrialautomation@renishaw.com**

© 2021–2024 Renishaw plc. All rights reserved. This document may not be copied or reproduced in whole or in part, or transferred to any other media or language by any means, without the prior written permission of Renishaw.  
RENISHAW® and the probe symbol are registered trade marks of Renishaw plc. Renishaw product names, designations and the mark 'apply innovation' are trade marks of Renishaw plc or its subsidiaries. Other brand, product or company names are trade marks of their respective owners.  
Renishaw plc. Registered in England and Wales. Company no: 1106260. Registered office: New Mills, Wotton-under-Edge, Glos, GL12 8JR, UK.

WHILE CONSIDERABLE EFFORT WAS MADE TO VERIFY THE ACCURACY OF THIS DOCUMENT AT PUBLICATION, ALL WARRANTIES, CONDITIONS, REPRESENTATIONS AND LIABILITY, HOWSOEVER ARISING, ARE EXCLUDED TO THE EXTENT PERMITTED BY LAW. RENISHAW RESERVES THE RIGHT TO MAKE CHANGES TO THIS DOCUMENT AND TO THE EQUIPMENT, AND/OR SOFTWARE AND THE SPECIFICATION DESCRIBED HEREIN WITHOUT OBLIGATION TO PROVIDE NOTICE OF SUCH CHANGES.

Part no.: H-6828-8000-03-A  
Issued: 02.2024