



Transforming
Tomorrow
Together

Financial highlights

Revenue

£565.6m

(2020: £510.2m)

Adjusted* profit before tax

£119.7m

(2020: £48.6m)

Statutory profit before tax

£139.4m

(2020: £3.2m)

Total dividend for the year

66.0p

(2020: 0p)

Adjusted* earnings per share

132.0p

(2020: 51.0p)

Statutory earnings per share

153.2p

(2020: 0.4p)

Front cover illustration:

FORTIS™ is a new innovative enclosed linear absolute encoder for use in harsh environments such as machine tools – see page 15.

Contents

Strategic Report

01	Our purpose and vision
02	Renishaw at a glance
04	Business model
06	Chairman's statement
08	Chief Executive's review
12	Our strategic objectives
18	Key performance indicators
20	Financial review
24	Our principal markets
26	Performance review
30	Risk management
34	Principal risks and uncertainties
44	Viability statement
46	Managing our resources and relationships
55	Task Force on Climate-related Financial Disclosures and Non-financial reporting statement
56	Section 172 statement

Governance

58	Directors' Corporate Governance Report
60	Board of Directors
62	Executive Committee
68	Nomination Committee Report
71	Audit Committee Report
77	Directors' Remuneration Report
94	Other statutory and regulatory disclosures
97	Directors' responsibilities
98	Independent Auditor's Report

Financial statements

107	Financial statements contents
108	Consolidated income statement
109	Consolidated statement of comprehensive income and expense
110	Consolidated balance sheet
111	Consolidated statement of changes in equity
112	Consolidated statement of cash flow
113	Notes (forming part of the financial statements)
144	Company balance sheet
145	Company statement of changes in equity
146	Notes to the Company financial statements

Shareholder information

156	10 year financial record
157	Additional information
157	Greenhouse gas emissions
158	Glossary and trade marks
159	Shareholder information

* Note 28, Alternative performance measures, defines how Adjusted profit before tax and Adjusted earnings per share are calculated.

We use abbreviations and trade marks within this document. For brevity, we do not define or identify these every time they are used; please refer to the glossary on page 158 for this information. Dates within this document refer to financial years unless otherwise stated.

Our purpose and vision

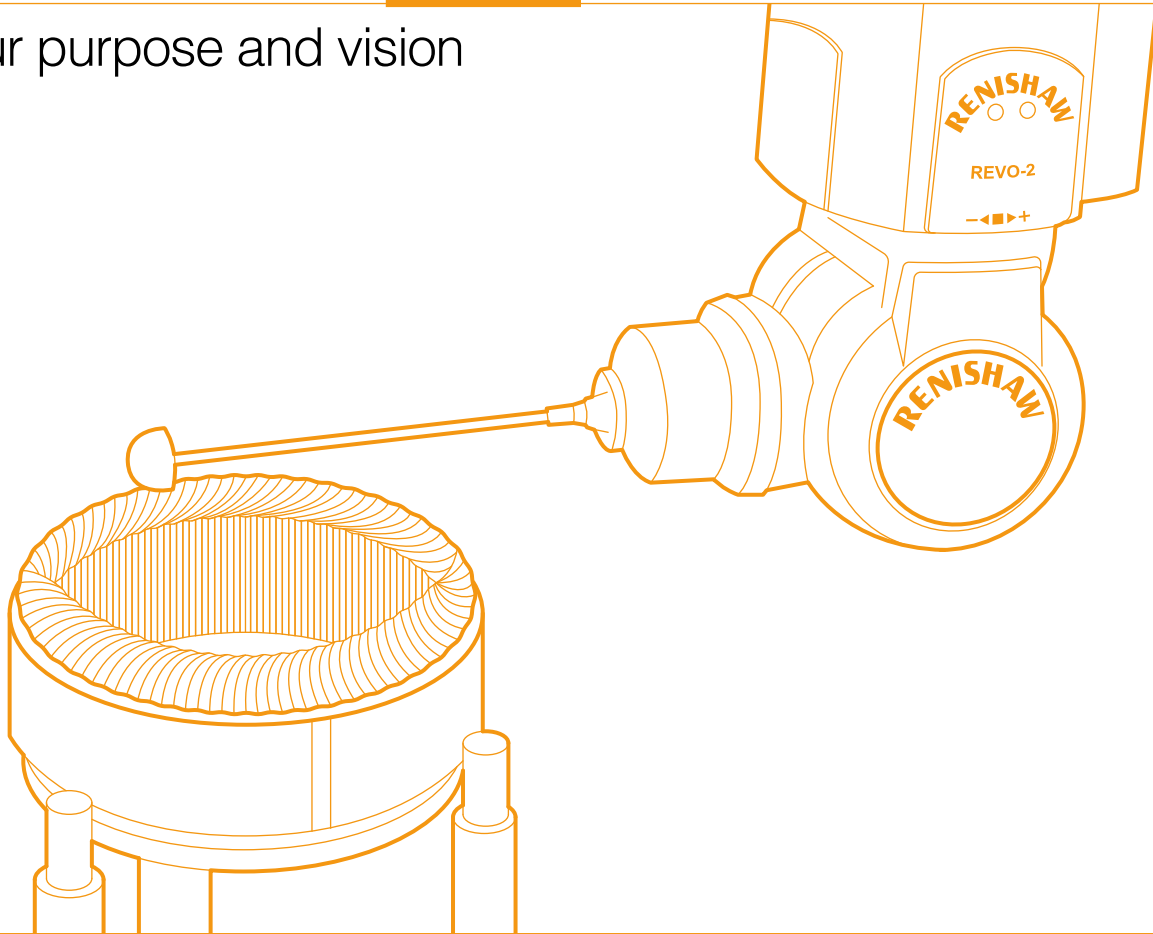

Transforming Tomorrow Together

Renishaw is a global provider of manufacturing technologies, analytical instruments and medical devices.

Our purpose is to make it possible to create the products, materials and therapies that will define our world in the decades to come and touch billions of lives.

By pursuing our purpose, we can continue to be a world leader in precision technology and deliver on our vision to innovate and transform capabilities in manufacturing, science and healthcare through unparalleled levels of precision, productivity and practicality.

Illustration:

Renishaw's REVO® system uses synchronised motion and 5-axis measurement technology to minimise the dynamic effects of CMM motion at ultra-high measurement speeds.

REVO is used in the automotive industry to inspect high-efficiency electric motors found in the latest generation of electric cars. The air gap between the rotor and stator in these assemblies is critical to ensure electrical efficiency to maximise driving range.

Renishaw at a glance

What we do

We work closely with our customers to solve complex engineering and science challenges and improve products and processes. Our unique blend of pioneering research and product innovation helps push the boundaries of what is possible, transforming product performance and touching billions of lives around the world.

We have two operating segments: Manufacturing technologies, and Analytical instruments and medical devices.

Manufacturing technologies (formerly Metrology)

The products in our Manufacturing technologies segment of the business (formerly referred to as Metrology) are enabling the factories of the future. From metal part manufacture on machine tools and additive manufacturing systems (AM), to industrial automation and motion systems, manufacturers rely on us. We provide customers with products that support precise, intricate production processes; higher process yields; faster cycle times; and greater automation. We also provide easy-to-use solutions with embedded knowledge and data analytics.

Industrial Metrology



Position Measurement

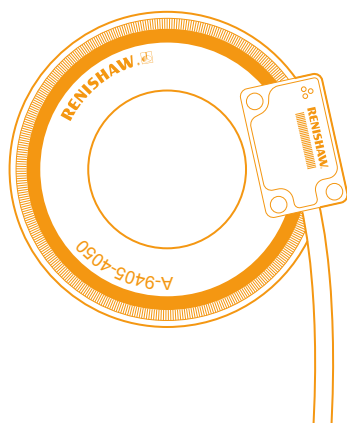

Additive Manufacturing

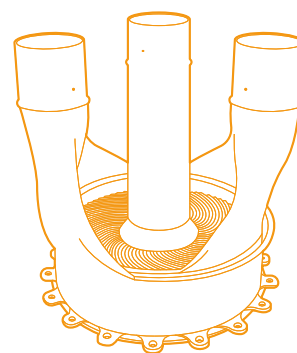

Analytical instruments and medical devices (formerly Healthcare)

Our innovative technologies also bring precision, productivity and practicality to a wide range of applications, including advanced materials analysis, brain surgery, facial reconstructive surgery and dentistry. Our spectroscopy systems give researchers a deeper understanding of materials and their interactions at a molecular level, including biochemical changes associated with disease formation and progression. Our robots and drug delivery devices help deliver precision for life-enhancing therapies for neurological conditions. We also supply specially configured metal additive manufacturing systems for medical and dental applications.

Spectroscopy

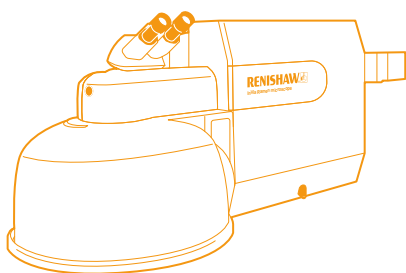

Neurological

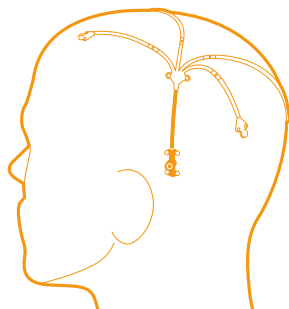

Medical Dental



Where we operate

APAC

Locations

32

Total revenue

£274.8m

■ Manufacturing technologies revenue

£262.3m

■ Analytical instruments and medical devices revenue

£12.5m

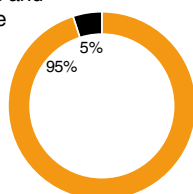

EMEA

Locations

38

Total revenue

£169.1m

■ Manufacturing technologies revenue

£150.6m

■ Analytical instruments and medical devices revenue

£18.5m

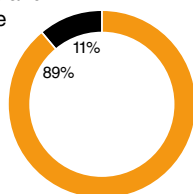

Americas

Locations

9

Total revenue

£121.7m

■ Manufacturing technologies revenue

£113.4m

■ Analytical instruments and medical devices revenue

£8.3m

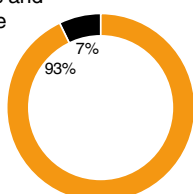

We use the term APAC throughout this report to refer to the Asia Pacific region, and EMEA to refer to Europe, the Middle East and Africa.

Our principal markets and key trends



Aerospace

New fuel-efficient engines with complex parts requiring faster measurement and cost-effective manufacturing processes.

Ongoing short-term impacts on civil aircraft production due to the pandemic.

Improvements to fuel efficiency by minimising airframe weight. Research into Net Zero aircraft.



Automotive

Cost efficiencies and flexible, automated processes needed throughout the supply chain.

Increasing sector investment in hybrid and electric vehicles with reduced investment in internal combustion engines (ICE).

Improved fuel efficiency requires tighter tolerances on powertrain components. Focus on reducing gearbox noise in electric vehicles (EV).



Consumer electronics

Increased demand for computing devices driven by home working and online schooling.

Electronic devices and household appliances demand precision manufacturing systems for product fit and finish.

Complex integrated circuits and new designs needed for 5G mobile products.

Shorter product life cycles need flexible manufacturing systems.



Power generation

Increasing focus on maximising output from equipment used in power generation, including wind turbines and solar panels.

Increasing research into energy storage.

Civil nuclear, wind and solar energy require manufacture of precision components.



Agriculture

Increasing global demand for food products due to growing population and rising incomes.

Investment in machinery for intensive farming and technology to increase yields, and reduce environmental costs.

Smart farming, including geomapping satellites, and greater automation.



Construction

Skills shortages and the need to minimise labour costs requires more automation by equipment manufacturers.

Drive to improve efficiency of large diesel engines used for vehicles in the sector. Longer-term plans to switch to hydrogen fuel cells.

Major infrastructure projects increase heavy equipment sales.



Healthcare

An increase in life expectancy means greater demand for healthcare products and procedures.

Growing demand for orthopaedic implants and patient-specific implants.

Neurological disorders need faster and highly precise surgical therapies.

Growing demand for cosmetic dentistry with superior aesthetics.



Resource exploration

Global population growth and urbanisation drive long-term demand for fossil fuels.

Equipment manufactured to stringent safety requirements needs accurate, cost-effective and traceable processes.

Fossil fuels need exploration in demanding terrains or more research into optimal extraction.

► See pages 24 and 25, Our principal markets, for further details.

Business model

We have a simple business model.

We work with our customers to understand their challenges, design products to solve these challenges and then manufacture these products ourselves. Here is an overview of what we do, how we do it and how this delivers value for our stakeholders.

Our resources



Customer relationships

Our trusted relationships with customers help us to understand their challenges. Our local service helps us to build these relationships, with 79 offices in 37 countries.



People

We employ around 4,600 talented people globally, committed to delivering our purpose, vision and strategy.



Suppliers

We work with suppliers around the globe, using our relationships with them to source high-quality components and raw materials.



Research & development

We make significant commitments in R&D, with dedicated new product innovation teams and an in-house patents team to protect our innovations and deliver long-term value.



Financial resources

We have a strong balance sheet, with significant cash balances and own our manufacturing facilities outright. We have very low levels of external financing, using this to finance property acquisitions when it makes commercial sense to do so, but otherwise finance our growth through operating cash flows.

Delivering value for...

Our customers

- £76.6m spent on developing new products and improving our existing products.
- 85 webinars delivered following the switch to online training and support.

Our people

- £224.8m of salaries, bonuses, 'thank you' payments, social security and pension contributions.
- More than 130 new roles or vacancies were filled by internal candidates this year.

Our suppliers

- £119.5m spent on materials and services.
- 47 days average payment time in the UK.

Our planet

- 5% reduction of our market-based statutory greenhouse gas (GHG) emissions.
- More than 90% of Group waste has been diverted from landfill.

Our communities

- £0.2m of charitable donations paid in the year.
- Engaged with 5,000 students in workshops on 3D printing and coding.

Our shareholders

- 146% increase in Adjusted* profit before tax.
- £10.2m interim dividend paid in the year, following cancellation in 2020.



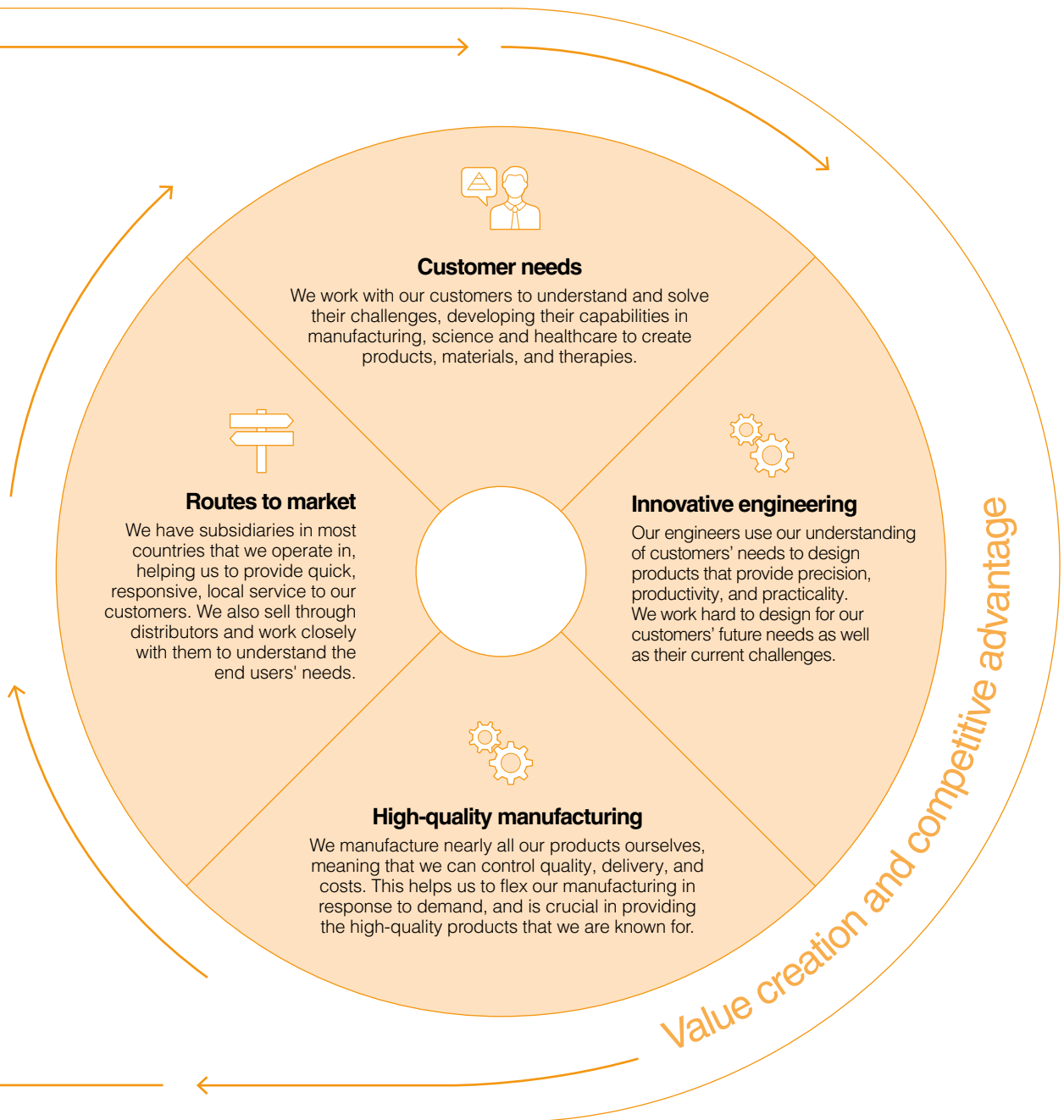

Chairman's statement



We have recovered well and our employees have shown great resilience in maintaining supply and excellent levels of support to our customers around the world. I am excited about our new products in development and the opportunities presented by global market trends.”

Sir David McMurtry
Executive Chairman

Sir David McMurtry co-founded Renishaw in 1973 with John Deer, who is now Non-executive Deputy Chairman. In his role as Executive Chairman, he is focused on the next generation project for AM, and he continues to be a major driver of innovation in the business. He has made a significant contribution to our long-term sustainable success and all aspects of the business.



Introduction

It has been a positive year of recovery and I am pleased to report that our revenue for the 2021 year was £565.6m, 11% higher than the 2020 revenue of £510.2m (13% higher at constant exchange rates). This was against a backdrop of improving economic conditions. Adjusted* profit before tax amounted to £119.7m (2020: £48.6m), an increase of 146%. Statutory profit before tax was £139.4m (2020: £3.2m). Both revenue and Adjusted profit before tax are consistent with the guidance provided in July.

We achieved strong revenue growth in our APAC region, where we continue to see strong demand for our encoder product lines which are benefiting from increased investments in the semiconductor and electronics capital equipment markets. Our EMEA and Americas regions both achieved modest revenue growth, with the first half of the year mirroring the second half of 2020 due to the pandemic, but with strong growth in the second half of 2021. They have continued to be affected by the ongoing uncertainty caused by the pandemic and consequent challenges to key sectors, particularly aerospace.

Our Fit for the Future initiative, which began in 2020, has focused on productivity and has reduced our cost base. This is reflected in the much-improved profitability compared to last year. The initiative resulted in a number of actions including a resizing of the business, a restructure of our Additive Manufacturing (AM) business, and a focus on prioritising significant design projects.

In March, Renishaw announced that John Deer (our Non-executive Deputy Chairman), and I, had indicated to the Board our intention to sell our entire combined shareholdings in the Company together, we own approximately 53% of the issued share capital of the Company. Having considered various options with our advisers, the Board unanimously agreed that it would be appropriate to investigate the sale of the Company and therefore launch a formal sale process (FSP).

Throughout this process, we considered the interests of all our stakeholders and looked for a buyer who would respect the unique heritage and culture of Renishaw, its commitment to the local communities where we operate, and who would enable the Company to prosper in the long term.

The Board, together with our advisers, carefully reviewed a number of proposals from potential buyers. We unanimously concluded that none would meet the Board's objectives of delivering an outcome that satisfactorily met the interests of all stakeholders. We therefore announced in July 2021 that we had unanimously decided to conclude the FSP and that John and I had indicated to the Board that we remain committed to Renishaw.

Reacting to a new world

The pandemic has resulted in profound changes to our society, the business environment and business practices. Many of these changes will be with us for the long term and we recognise the risks and the opportunities that this brings to our business.

Across the world the pandemic is accelerating trends around digitalisation, automation, near-shoring, remote working and sustainability. For Renishaw this presents significant positive opportunities, as our products are well placed to support our customers as they respond to these new challenges. We recognise that the workplace has changed and that it is possible for many roles to successfully combine remote and site-based working. We have therefore implemented a hybrid working policy in the UK, where non-manufacturing employees will split their week between on-site and home working.

As a business we also recognise the increased need for sustainability and the need to accelerate our own work in this area. We have made significant efforts to reduce our carbon emissions in recent years (see page 54). However, like many organisations there is much more that we must do to meet the challenges of climate change and we are currently developing a Net Zero strategy.

Corporate governance

We remain committed to high standards of corporate governance and considering key stakeholders when making decisions, in the belief this will protect our business and its long-term sustainable success. Further details are provided in the Directors' Corporate Governance Report on pages 58–97 and our Section 172 statement on pages 56–57.

Our culture

The ongoing pandemic has continued to affect our business and employees around the world. Despite this challenging environment we remain resilient, and our people have continued to maintain supply and excellent levels of support to our customers around the world, many of whom are in critical global supply chains. I would again like to thank our people for demonstrating professionalism and dedication, despite the ever-changing circumstances, and the challenges that many have faced in their own personal lives due to the pandemic.

These challenges have highlighted the importance of our strong working culture at Renishaw and we are pleased to have started the process of communicating how our core business values of inspiration, involvement, innovation and integrity help to support our new purpose and vision. These values embody our culture, where our people are encouraged:

- to be innovative and challenge convention;
- to always act with integrity;
- to inspire each other, our customers and our wider communities; and
- to be fully involved and support each other in contributing to the success of Renishaw and our communities.

We will achieve this by embedding these values within the business through leadership and processes that recognise and reward behaviours that embody our four values.

Values workshops hosted by our global values ambassadors have been held in the UK and across our regions. These communicated our values, demonstrated how they can be applied to everyone's role, how they will support our purpose and vision, and helped us understand what these values mean to our people.

Our value of involvement supports our commitment to equality and diversity initiatives at all levels of the company. Our UK Diversity & Inclusion group led initiatives during the year, including celebrating our first Inclusion Week, where we focused on the meaning of inclusion, gender, cultural awareness and mental health.

Dividend

Given the uncertain trading conditions last year, there were no dividends in respect of 2020.

With improved profits and cash balances this year, we have reinstated the dividend programme, with an interim dividend of 14.0 pence net per share paid on 6 April 2021. The Board is pleased to propose a final dividend of 52.0 pence net per share.

Sir David McMurtry
Executive Chairman

21 October 2021

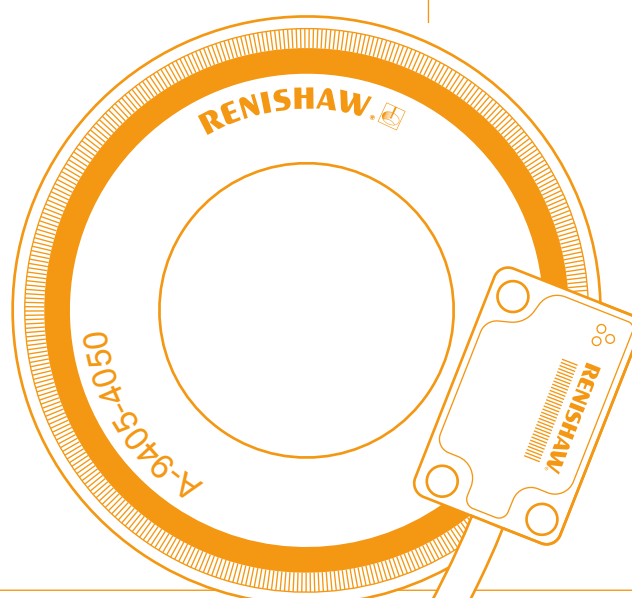

Our encoder product lines all achieved record sales, primarily due to very positive demand from the semiconductor and microelectronics sectors, which has led to global shortages of chips. The pandemic has led to high demand for electronic products including laptops, webcams, monitors, games consoles and supporting infrastructure for streaming and cloud-based services, while many vehicles now use semiconductor chips for control systems, infotainment systems and digital dashboards.

* Note 28, Alternative performance measures, defines how Adjusted profit before tax, Adjusted earnings per share, Adjusted operating profit and Revenue at constant exchange rates are calculated.

Chief Executive's review



Our employees have demonstrated our core values of innovation, inspiration, integrity and involvement during the year. Their commitment has put us in a strong position to take advantage of the many opportunities we now see arising from the global recovery.”

Will Lee
Chief Executive

Will Lee was appointed Chief Executive in 2018, having originally joined Renishaw as a graduate in 1996. He has held various senior management positions in engineering, operations and sales and marketing, resulting in an in-depth understanding of our business, products and markets. During the year he presented our new purpose, vision and strategy to our people.



Introduction

There has been a good recovery for our business, and I am proud of our people who have again risen to the challenges faced. During the second half of the year we started to see a recovery in some of our key markets, and we ended the year dealing with the demands of a record order book and supplying our customers in the face of global supply chain challenges. We have recruited strongly in our manufacturing operations to increase capacity, and our logistics teams have responded admirably to another challenging period.

Our customers have appreciated our support. This has left us in a very strong position to grow with them as they now experience new opportunities arising from the recovery in their markets.

During the year, I spent time with all our global employees communicating our new purpose, vision and strategy, and how every individual can help to deliver on these. Together, we are in a strong position to innovate and transform capabilities in manufacturing, science and healthcare, through unparalleled levels of precision, productivity and practicality, and help our customers create the products, materials and therapies that will define our world in the decades to come.

As Sir David has already mentioned, in March we launched an FSP for the Company. However, having received no proposals that the Board felt satisfactorily met the interests of all our stakeholders, we announced the closure of the process in July. I am delighted that the founders have indicated their continuing commitment to Renishaw, and it continues to be very much business as usual for the Board and our employees as we focus on delivering our strategy for success.

COVID-19 pandemic

Our priorities during this pandemic continue to be the health and welfare of our employees, their families and the wider communities in which we operate, and to maintain high service levels to our global customer base.

We have a wide range of robust COVID-secure working practices in place to protect against the spread of the virus. Within the UK, where we have higher numbers of employees, we have introduced twice-weekly self-testing for all employees who are working on-site. All our manufacturing facilities around the world are operating as normal, and we have maintained supply to customers. Like many other manufacturers our lead times have increased due to global shortages of certain components and materials.

Many of our non-manufacturing employees have worked remotely throughout the pandemic, and while this has generally been a positive experience in terms of productivity, we recognise the benefits of in-person collaboration. We have therefore agreed a hybrid working policy, initially in the UK.

The pandemic has brought forward many digital initiatives, including the expansion of the use of digital collaborative tools for customer support, and the use of marketing automation, virtual exhibitions and webinars to ensure a supply of high-quality sales opportunities.

Performance overview

As already outlined by Sir David (see page 6), we have seen good growth in revenue and Adjusted operating profit for the Group. There was notably strong growth for our position encoder product line due to demand from the semiconductor and electronics sectors, which were boosted by high pandemic-related demand for products including laptops and games consoles. Most of our other lines also grew due to a strong global recovery in the second half of the year. We achieved strong revenue growth

in our APAC region, with a particularly strong recovery in China based on general demand across multiple sectors.

Revenue

We achieved revenue for the year ended 30 June 2021 of £565.6m, compared with £510.2m last year. As previously communicated, we have worked closely with key customers throughout the pandemic to ensure that we were in a position to meet their requirements when economic conditions improved, and we are now benefiting from that approach. While the challenges remain, we are well placed to take advantage of the opportunities presented by the global economic recovery.

The split of our revenue by region is shown in the table below.

	2021 £m	2020 £m	Change %	Constant fx change %
APAC	274.8	227.7	+21	+23
EMEA	169.1	167.2	+1	+1
Americas	121.7	115.3	+6	+9
Total Group revenue	565.6	510.2	+11	+13

Revenue

£565.6m
(2020: £510.2m)

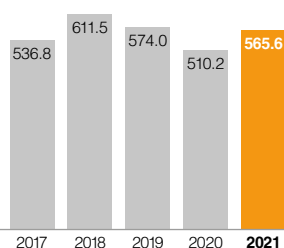

Dividend per share

66.0p
(2020: 00.0p)

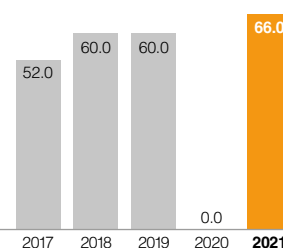

Statutory profit before tax

£139.4m
(2020: £3.2m)

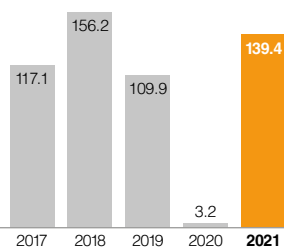

Statutory earnings per share

153.2p
(2020: 0.4p)

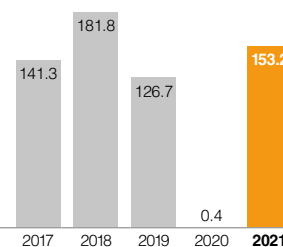

Adjusted* profit before tax

£119.7m
(2020: £48.6m)

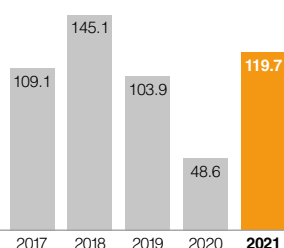

Adjusted* earnings per share

132.0p
(2020: 51.0p)

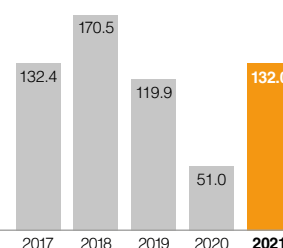

Chief Executive's review continued

Profit and earnings per share

Our Adjusted profit before tax for the year was £119.7m compared with £48.6m last year. Adjusted* earnings per share was 132.0p compared with 51.0p last year.

Statutory profit before tax for the year was £139.4m compared with £3.2m last year. Statutory earnings per share was 153.2p compared with 0.4p last year.

This year's tax charge is £28.0m (2020: £2.9m) representing a tax rate of 20.1% (2020: 91.0%). For further details on the tax rate see page 124.

Manufacturing technologies

During the year, we used the launch of our purpose, vision and strategy to rename our operating segments to better reflect the business.

Our Manufacturing technologies business consists of Industrial Metrology, Position Measurement, and Additive Manufacturing (AM) product groups. Revenue from our Manufacturing technologies business for the year (formerly 'Metrology') was £526.2m compared with £475.2m last year.

While the pandemic continues to affect some of our key sectors, primarily aerospace, in the second half of the year we have seen a strong recovery in sales and orders for most of the product lines which make up this segment (see page 26). The strongest recovery has been in APAC, where we have seen strong growth over the last year but there are positive signs of returning confidence in all our regions.

We have seen growth in demand for most of our Manufacturing technologies products, notably in our machine tool product line, our gauging product line, and our optical, laser and magnetic encoder product lines. The encoder product lines have all experienced record sales due to strong investment in the semiconductor and electronics capital equipment markets. Our co-ordinate measuring machine (CMM) product line experienced reduced demand in the first half of the year due to the challenges in some sectors, particularly aerospace. However, our strong portfolio of measurement products and global customer base means that we are already benefiting from a recovery in sector investments, and the CMM line full-year revenue was only slightly below last year.

The geographical analysis of Manufacturing technologies revenue is set out below:

	2021 £m	2020 £m	Change %
APAC	262.2	213.6	+23
EMEA	150.6	152.5	-1
Americas	113.4	109.1	+4
Total Manufacturing technologies revenue	526.2	475.2	+11

Our AM product line revenue was also lower than last year but was in line with our expectations following the restructuring of the business in 2020. Demand for the RenAM 500Q multi-laser system was affected by the challenging market conditions, especially within the aerospace sector. With the benefits of our multi-laser systems for high-quality, productive metal part manufacture now being proven with key customers, and the soon-to-be-available Flex system (for rapidly changing between differing materials during process prove-out), we are well placed to benefit from an improvement in market conditions and the expansion of AM into new applications.

Adjusted* operating profit for our Manufacturing technologies business was £112.6m (2020: £50.3m).

We continued to invest in R&D, with total gross engineering costs of £70.6m compared with £75.9m in 2020.

We launched a number of new products during the year. Our machine tool product line introduced the second-generation NC4+ Blue non-contact tool setting system, with ultra-compact design and measurement repeatability down to ±0.5 microns. Within our position encoder product line, a significant addition was the FORTiS enclosed linear absolute encoder for harsh production environments, including machine tools.

Analytical instruments and medical devices

Revenue from this business for the year was £39.4m, an increase of 12% on last year. We saw growth in our spectroscopy and neurological product lines, notably the latter, which experienced record sales during the year, boosted by hospitals in key markets restarting elective surgery as COVID-19 patient numbers fell.

While there remain challenges, confidence has returned to all our key markets. Funds for capital expenditure projects which were postponed last year are being released and we are seeing a good recovery in industrial and academic research budgets which will benefit our spectroscopy and neurological lines.

Adjusted* operating profit was £5.9m, compared with £1.4m last year.

We continued to invest in R&D, with total gross engineering costs in this business segment of £6.0m compared with £6.5m in 2020.

During the year, our neurological product line agreed to work with a major pharmaceutical company on a programme for a new candidate drug using our drug delivery system. The rapid growth of potential gene therapy treatments for neurological diseases and disorders is also generating significant interest in our delivery device (see page 29).

The spectroscopy product line introduced a new Particle Analysis software module for our inVia™ Raman spectrometer system, which enables multiple spectra captured on filter paper to be automatically analysed and categorised by shape, size and chemistry. This has applications for the detection of microplastics in drinking water.

Strategy and markets

Our overarching strategy to deliver our purpose and vision is based on creating strong market positions with patented and innovative products and processes; cost-effective in-house manufacturing that delivers high-quality products; strong global support to ensure our customers achieve success; support services that ensure an efficient, intelligent and responsible business; and fostering a culture that allows us to attract and retain talented and motivated people who will deliver our strategy. This strategy underpins all our product lines, for which we also have individual commercial and product strategies (see pages 26-29).

From transport to agriculture, electronics to neurosurgery, our vision is to innovate and transform capabilities in manufacturing and healthcare through unparalleled levels of precision, productivity and practicality. In a world of increasingly scarce resources this is especially important to help our customers to develop products and processes that are sustainable, deliver higher levels of performance through increased efficiency, make intelligent use of data, and are customised to suit individual requirements.

We continue to see external market growth drivers that are creating positive opportunities for our business. These include global skills shortages, digitalisation, near-shoring and reshoring, sustainable manufacturing, population growth and increasing life expectancy. An analysis of our principal markets can be seen on pages 24 to 25.

Focused investment for long-term growth

We strongly believe in our long-term strategy of delivering sustainable growth through:

- investments in R&D that are focused on products that deliver unparalleled levels of precision, productivity and practicality;
- investments in in-house manufacturing that give us control over quality, delivery and costs; and
- investments in our global marketing and distribution infrastructure.

However, with the global economic uncertainties during the year, our short-term focus has been on maximising the benefits of the investments we have made over the past few years and clearly prioritising those 'flagship' projects that either bring faster revenue benefits or are strategically important to the business. The launch of the FORTiS encoder is a good example of this.

We continue to invest to improve productivity through development programmes for our people, our Workday® human resources system, and the planned deployment of Microsoft Dynamics 365 enterprise resource planning and customer relationship management application.

Working capital

Inventories increased to £113.6m from £105.5m at the beginning of the year, as a result of the higher trading levels and our decision to increase safety stock levels of critical components, where possible, to mitigate the risk of supply chain disruption.

Trade receivables increased from £105.1m to £114.7m in line with increased sales. There was an improvement in debtor days to 61 at the end of the year, compared with 76 at the end of last year, which includes a currency translation gain of £7.8m. There have been no significant bad debts during the year.

As a result of our strong trading performance, reduced levels of capital expenditure, and the decision not to propose a final dividend for 2020, we have healthy net cash and bank deposit balances at 30 June 2021 of £215.0m (2020: £120.4m), and a corresponding improvement in our liquidity position over the year.

Sustainability and community

We reduced our market-based statutory greenhouse gas (GHG) emissions by 5%, and introduced a new Group policy to only use electricity from certified renewable sources, where possible. Despite the pandemic we still reached more than 5,000 children with new virtual education outreach programmes, including interactive workshops and work experience weeks, and we assisted local organisations through charitable donations and practical support.

Our people

Our workforce at the end of June 2021 was 4,664 (2020: 4,463), an increase of 5%. During the year, 40 apprentices and graduates were taken on as part of our ongoing commitment to train and develop skilled resource for the Group in the future. We also took on 19 industrial placements in the year.

During the year we continued to face challenges. This included the pandemic, tough trading conditions, lower headcount (due to the redundancies and recruitment freeze in 2020) which increased pressures in some areas of the business, and the formal sale process. There were also huge demands placed on our manufacturing operations as we saw a strong recovery in demand accompanied by global shortages of key components.

It is testament to the continuing resilience, skill and dedication of our people that during the year they supplied and supported our customers, introduced innovative new products, progressed key projects that will underpin the future of our business, and supported each other and our local communities. They truly demonstrated our four core values, while continuing to help Renishaw deliver on our purpose and vision, and as a Board we are truly grateful for their contributions during another challenging year.

Brexit

To mitigate against the potential impacts of the UK leaving the EU, we have taken actions in recent years including establishing a warehouse in Ireland, expanding our existing warehouse in Germany, and increasing the inventory of certain finished goods and components at sites within the EU and the UK. Although there have been some delays at the UK borders for shipments into the EU since 1 January 2021, the measures that we have taken have minimised the impact on customer service.

Outlook

The outlook for our segments can be seen on pages 27 and 29. The 2022 financial year has started with a strong first quarter and we currently have a record order book. We expect demand from the semiconductor and electronics sectors to remain strong and that there will continue to be a recovery in the machine tool market and coordinate measuring machines market. In our Analytical instruments and medical devices markets, we have seen confidence return and capital expenditure projects released.

The Board continues to be confident in our long-term prospects, due to our strong financial position, the high quality of our people, our innovative product pipeline, extensive global sales and marketing presence and relevance to high-value manufacturing.

Will Lee

Chief Executive

21 October 2021

* Note 28, Alternative performance measures, defines how Adjusted profit before tax, Adjusted earnings per share, Adjusted operating profit and Revenue at constant exchange rates are calculated.

Our strategic objectives

Our strategy focuses on maximising the benefits of our efficient and responsible processes, creating innovative solutions, responsive local service and quality manufacturing. Our product and commercial strategies provide divisional and geographic focus.

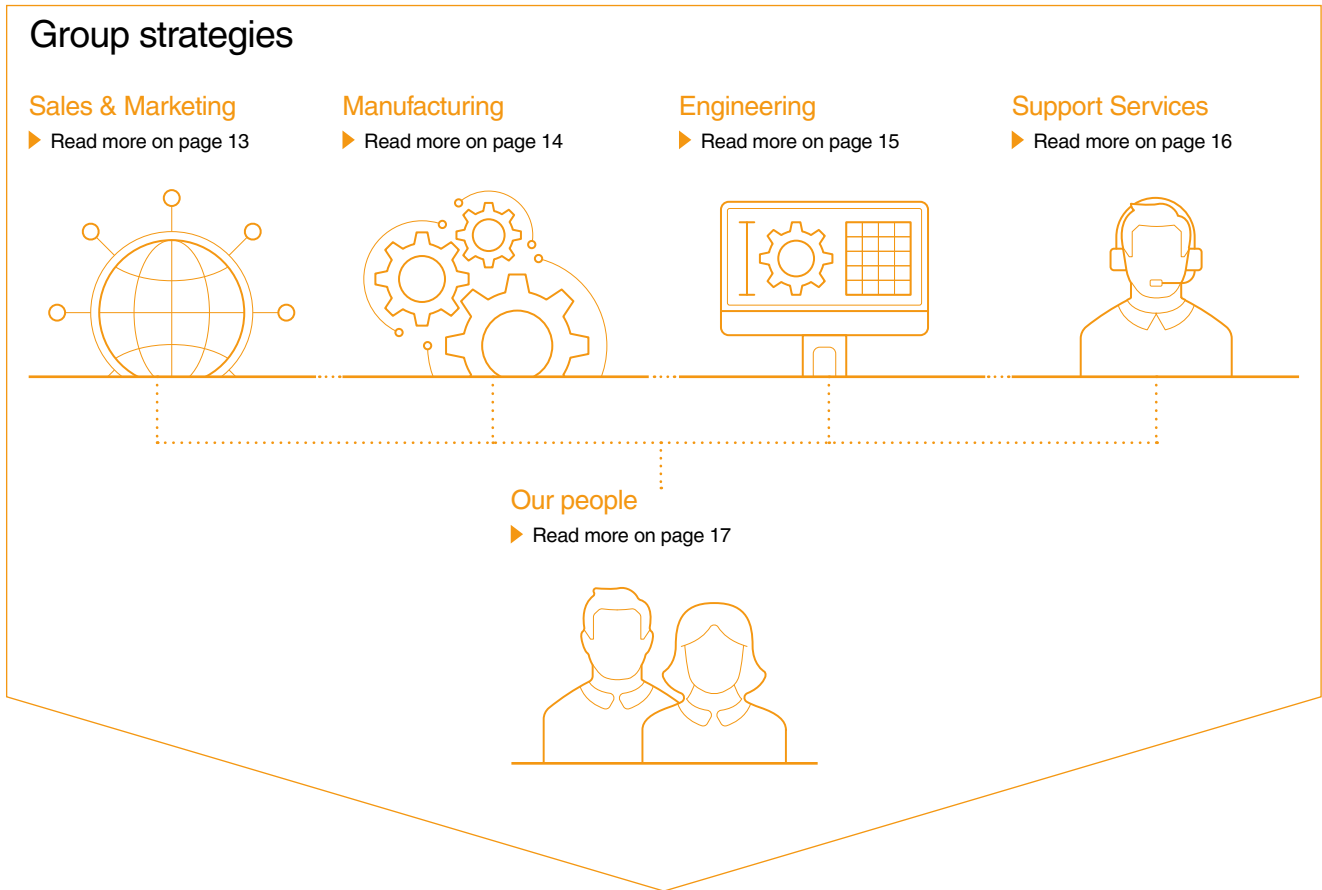

Product and commercial strategies

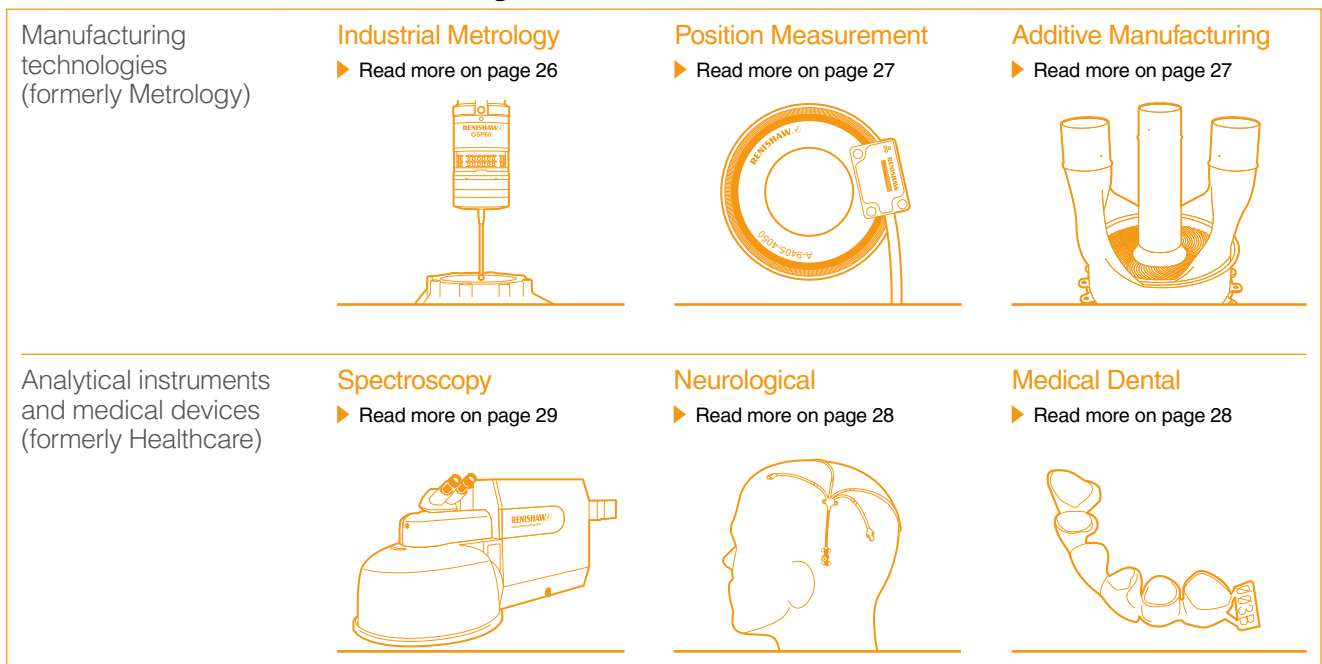

Sales & Marketing

Supporting our customers' success around the world

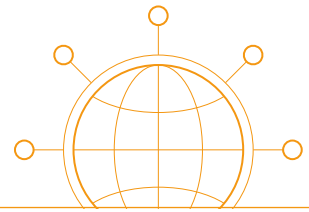

Strategic objectives

Maximise our customers' satisfaction and return on investment through excellent customer care.

Effective sales and support channel strategy to manage different customer types profitably.

Industry-leading digital customer experience supports innovation and maintains competitiveness.

Trusted relationships with our OEM and end-user customers.



Goals

Long-term profitable growth of revenue and market share.

Transactional costs managed effectively.

Improved customer retention.

Consistent strong brand value.



Our progress in the year

As the impact of the pandemic receded, market demand has rebounded, and we have worked closely with key customers around the world to support their growth.

We continue to target new customers, winning business from competitors through a combination of innovative technologies, responsive delivery and expert support.

Our investment in our global sales and service network continues, supporting the launch of recent new products and preparing for planned introductions in the year ahead.

COVID-19 restrictions have driven us to use more digital marketing to engage with our customers. In the absence of trade shows we hosted 85 webinars, and we are extending our use of marketing automation technologies to coordinate our email, web and social media messaging.

Our Smart Manufacturing Ambassadors programme, which gives social media training and support to customer-facing employees, has increased our online engagement and support for customers.



How we will be measuring success

Achieving our sales targets in our strategic business plan.

Securing new customer wins and a growing share of total customer expenditure.

Effective use of distribution to drive improved sales efficiency.

Customer satisfaction and retention.

Virtual-Expo

Our Virtual-Expo is an online interactive exhibition stand on [renishaw.com](https://www.renishaw.com), where visitors can see how our technologies are used throughout manufacturing industries. Our investment in the Virtual-Expo, along with other sales and marketing technologies, will provide the building blocks for more interactive and tailored customer experiences. This allows us to provide our expertise and support to customers in different industries around the world.



Our strategic objectives continued

Manufacturing

Cost-effective in-house manufacturing, delivering quality products on demand



Strategic objectives

In-house manufacturing to give us control over quality, delivery and costs.

Strategic inventory to enable responsive delivery to changing demand.

Global factory network with robust supply chains.

World-class facilities showcasing our technologies in action.



Goals

Improve customer satisfaction through superior product quality and better delivery.

Minimise controllable costs through:

- innovative process capability improvements and increased automation.
- monitoring material costs and consumption.

Reduce our carbon footprint and minimise all forms of waste at source.



Our progress in the year

The pandemic and a marked increase in sales has resulted in significant challenges for manufacturing. Despite this we have been able to maintain supply and support to our customers throughout the year.

We have recruited more than 300 manufacturing employees globally.

We have maintained product supply despite ongoing global supply chain challenges, such as shortages in electronics components and packaging materials.

Cost savings have been achieved through process optimisation, the adoption of value stream mapping (to minimise process waste and improve productivity), increased automation, and reducing component and quality costs.

Planning permission received for new buildings and associated infrastructure to support future growth at our Miskin site in South Wales, UK. This facility is primarily used for machining, assembly and additive manufacturing machine production.



How we will be measuring success

Reduction in customer-reported assembly and shipping error rates.

% of deliveries to subsidiaries that arrive on time.

We measure the above, and other operational objectives, using live data dashboards.

Value stream mapping for optical linear encoder production

Value stream mapping (VSM) is a lean management method that allows you to visualise, analyse and improve all the steps in a manufacturing process. Using customised VSM, to minimise process waste and improve productivity, we have developed a new manufacturing cell model for high-volume processes, replacing the 'one size fits all' approach. VSM has allowed us to highlight areas of waste, consolidate processes to reduce bottlenecks and reduce labour costs. We have also developed a toolkit that will enable us to use VSM for other product lines.



Engineering

Creating strong market positions with innovative products and processes

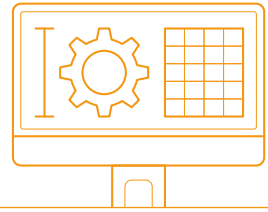

Strategic objectives

Sustained high levels of investment in engineering.

Expansion and extension of our product ranges to meet changing customer needs.

Patent and intellectual property generation, with an in-house patents team to protect our innovations.

Technology research to enhance future product performance.

Process innovation to enable high-quality, cost-effective manufacture.



Goals

Ensure on-time completion of flagship projects to deliver major new products.

Maintain exciting product roadmaps and a key technology research portfolio.

Work with Manufacturing to reduce product cost and improve quality.



Our progress in the year

We continued to invest in cutting-edge research to ensure we can deliver disruptive technologies for the future.

Investment in engineering development has remained central to our strategy and we continue to seek and employ the best engineers in their fields.

We have launched our first flagship product, FORTiS, an enclosed linear absolute encoder series. We are progressing with the delivery of three other flagship products over the next 12 months.

We have prioritised key projects across all engineering functions to focus resources on the products that are expected to bring faster revenue benefits or are strategically important.

84 patents were granted despite the challenges arising from the COVID-19 pandemic.



How we will be measuring success

Progressive analysis and improvement of the quality of our products in the field.

Regular launches of high-performing and innovative products to our existing markets.

Develop systems that through intelligent use of data will give our customers simplified and more predictable manufacturing processes.

Developing revenue in new markets with the successful introduction of non-substitutional new products.



Flagship products – FORTiS

In January 2021, we launched our first flagship product, FORTiS, a next-generation enclosed linear absolute encoder series, for use in harsh production environments such as machine tools. The FORTiS design is built upon our industry-proven RESOLUTE encoder technology and provides high resistance to the ingress of liquids and solid debris contaminants.

Our strategic objectives continued

Support Services

Enabling an efficient, intelligent and responsible business

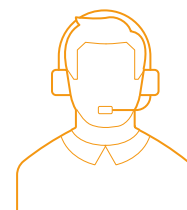

Strategic objectives

Continually improve our productivity through efficient and cost-effective organisation, systems and processes.

Ensure that we monitor and manage risks, making business decisions in the long-term interest of all our stakeholders.

Build on our reputation as a responsible business.



Goals

Clarify responsibilities, focus on key metrics, and simplify reporting.

Enhance our IT systems, and streamline processes.

Strengthen best practices in engineering and project management.

Business partnering to support the smooth running of the business.

Continue to meet our legal, ethical and community obligations and manage risks.



Our progress in the year

We formed our Group Operations function, consolidating many of our service teams to streamline decision making.

The work required to support the FSP process helped us to improve our business planning.

We continued to supply customers without significant disruption after the end of the Brexit transition period. Work to meet UKCA legislation (the UK equivalent to the CE mark) is underway.

We improved our Board and Executive Committee reporting packs, with more succinct reporting.

We have finalised the design phase for Microsoft Dynamics 365, and have nearly completed the build phase. Migration is expected to start in the first half of 2022.



How we will be measuring success

Meeting the UKCA requirements ahead of the deadline.

Reducing IT Helpdesk response times, and having fewer support calls by improving self-help capabilities.

Smooth roll-out of Microsoft Dynamics 365, using feedback gained from early adopters.

The Executive Committee and Board receive regular reports of each business area against financial objectives.

Digital transformation

We have several ongoing programmes including the global planned deployment of Microsoft Dynamics 365 to enhance customer engagement and improve finance and operation processes, and an e-commerce programme to improve online customer experience and increase opportunities to interact through our digital platforms.

This digital transformation initiative supports our strategy to maximise customer satisfaction and provide excellent customer care.



Our people

Providing a great place to work, grow and contribute

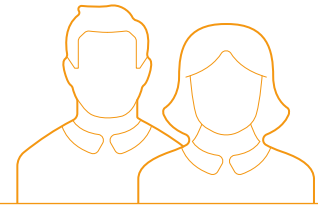

Strategic objectives

- Attract, retain and motivate our people.
- Develop skills to meet changing business needs.
- Create an inclusive culture with a diverse workforce.
- Be committed to wellbeing.



Goals

- Recruit people with our values.
- Grow our emerging talent.
- Provide accessible training.
- Enable career progression.
- Support increased engagement.



Our progress in the year

We introduced our new, global performance review process in 2021.

We welcomed 40 trainees into our business to support our future development.

Over 130 roles were filled by internal candidates in the year.

We launched our first Inclusion Week, and heard directly from our people on inclusion topics.

We supported our people throughout the year to deal with the impact of COVID-19, providing regular testing for those needing to work on site and sharing resources on how to look after our wellbeing.

Will Lee held video calls following the FSP announcement, and also held video calls to share our updated purpose, vision, and strategy with all our people.

We agreed our new policy for hybrid working in the UK, coming into effect in September 2021.



How we will be measuring success

- Global voluntary employee turnover rate.
- Gender and ethnic diversity, at all levels.
- Engagement surveys and feedback.



Inclusion Week

In September 2020 we launched our first Inclusion Week, with the aim of encouraging our people to feel welcomed, valued, and respected for who they are, and to help build a culture that supports this. The week was centred around a series of video interviews and discussions with people at a range of levels in the business, covering topics such as what inclusion means, how to support people as individuals, and cultural awareness.

We were really encouraged by the feedback we received afterwards, and look forward to building on the work we have started. One of the participants shared the following feedback with us:

“I have loved it all, thought-provoking, interesting and great to hear from my colleagues around the world.”

Key performance indicators

Following the updates to our strategy this year, we have reviewed our key performance indicators and removed some measures that are no longer the key measures used by the Board to monitor progress.

These measures are the number of new placements and graduates, and the number of apprentices in training, and are now reported on page 48. We have also removed Group energy consumption as a KPI, focusing instead on our GHG emissions.

Our strategic objectives on pages 12 to 17 also include some performance indicators that help us measure progress against our strategy.

Key

F Financial **NF** Non financial

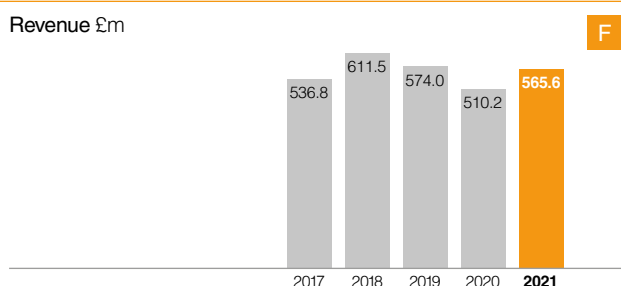

Why we measure this

Sustainable long-term growth is a key part of our strategy.

How we measure this

Revenue generated from operations, at actual rates of exchange.

How we performed

Revenue grew to £565.6m, an increase of 11% from 2020. Revenue in the second half of 2020 was negatively affected by COVID-19, and this continued into 2021. However, we saw significant growth in the second half of 2021 as more countries recovered from the initial economic impact of the pandemic. In addition, revenue in 2021 benefited from COVID-19, as the pandemic increased demand in some markets, such as consumer electronics. Growth was achieved in all regions, and by both of our operating segments.

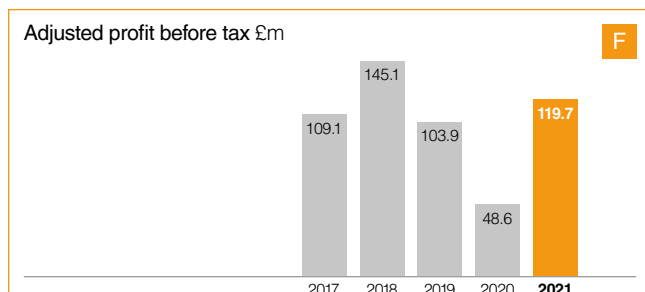

Why we measure this

This helps demonstrate the underlying trading performance of the business.

How we measure this

We adjust statutory profit before tax for the following items, to arrive at Adjusted profit before tax: fair value gains and losses from forward currency contracts which did not qualify for hedge accounting and which have yet to mature; third-party costs relating to the FSP; and restructuring costs.

How we performed

This has increased by 146% due to the significant increase in revenue, and from the continuing benefits of the cost management measures introduced in 2020's Fit for the Future initiative.

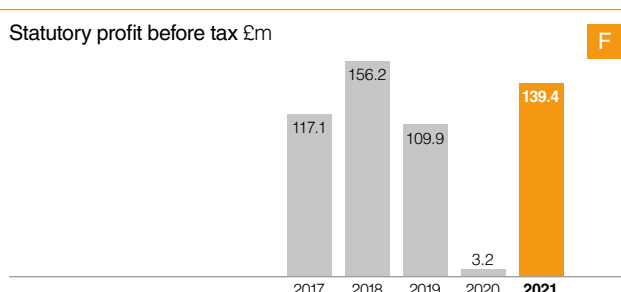

Why we measure this

Profit demonstrates how our strategy is delivering value for our stakeholders.

How we measure this

This is the statutory profit before tax as reported on page 108.

How we performed

This has increased for the same reasons as Adjusted profit before tax, but has a higher rate of growth. This is because last year's statutory profit included £23.8m of restructuring costs which have not repeated in 2021, and £24.3m of fair value losses on financial instruments not eligible for hedge accounting. In 2021, fair value gains on financial instruments not eligible for hedge accounting were £22.8m.

Total engineering costs including R&D £m

F

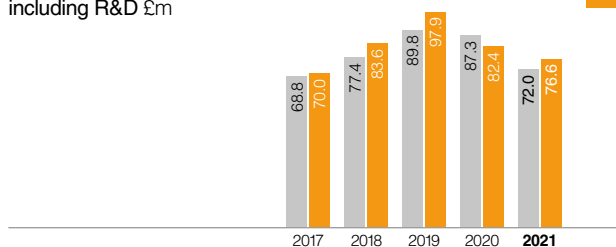

Why we measure this

Investment in engineering is fundamental to our growth.

How we measure this

Expenditure in the year on engineering, including R&D that has been capitalised in the year.

How we performed

Gross expenditure was £76.6m, lower than in 2020, with a focus in 2021 on flagship projects and a reduction in expenditure on non-core areas. This is consistent with our expectation.

■ Included in the Consolidated income statement
■ Gross expenditure

Dividend per share in respect of the year pence

F

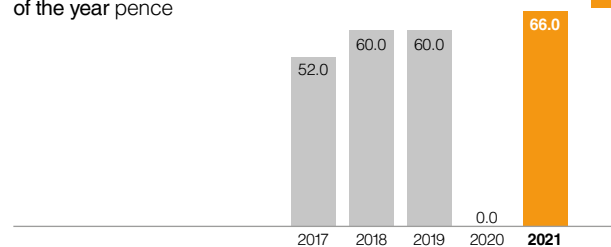

Why we measure this

To track the underlying performance of the business and measure whether profit growth translates into improving shareholder returns.

How we measure this

Interim dividend paid in the year, plus the proposed final dividend.

How we performed

We paid an interim dividend of 14 pence net per share in April and the Directors propose a final dividend of 52.0 pence net per share. If approved, this would bring the overall dividend per share to 66.0 pence, a 10% increase from the total dividend for 2019.

This improvement is a result of the improved profitability this year and the greater certainty over our financial position, following the uncertainty in 2020.

Global voluntary employee turnover %

NF

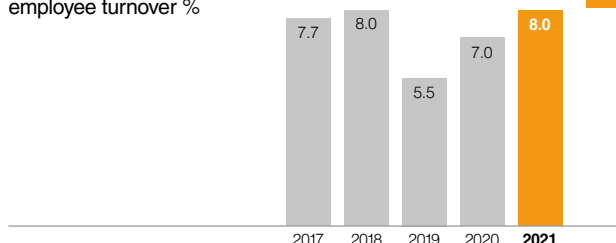

Why we measure this

Our people are critical to implementing our strategy, and are one of our competitive advantages.

How we measure this

The number of voluntary leavers (excluding voluntary redundancy, if applicable) in the year, as a percentage of our total headcount.

How we performed

While there has been no significant increase in voluntary turnover since last year, as a result of the pandemic, working practices have shifted towards more flexible working, such as hybrid working. This has resulted in some skills becoming more portable.

Statutory GHG emissions tCO₂e per £m turnover

NF

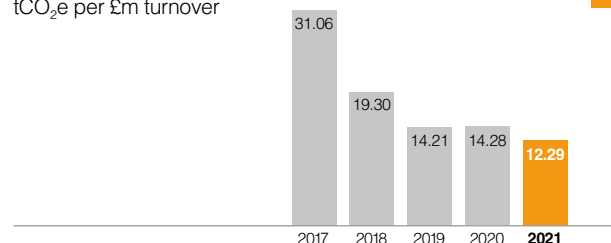

Why we measure this

This helps us measure whether we are doing business responsibly.

How we measure this

Tonnes of CO₂ emissions from our operations, per £m of revenue, using the market-based method.

How we performed

We are pleased to have again reduced our statutory GHG emissions in relation to our revenue. This was driven by the reduction in emissions from our own vehicles, as a result of the pandemic. This means we have also reduced our statutory emissions in absolute terms.

Financial review



I am delighted to report a year of strong recovery with significant growth in both profitability and cash generation.”

Allen Roberts
Group Finance Director

Revenue

Revenue for the year amounted to £565.6m, an increase of 11% compared with £510.2m last year. We achieved strong revenue growth in our APAC region, largely driven by increased investments in the semiconductor and electronics capital equipment markets. We also saw growth in the Americas and EMEA regions, with a notable increase in demand in the second half of the year as the economies continued to recover from the pandemic.

In our Manufacturing technologies business (previously Metrology), revenue increased by 11% to £526.2m, compared with £475.2m last year. We have seen growth in demand for many of these products, notably in our machine tool product line and our encoder product lines, mostly as a result of the continuing recovery in the semiconductor and electronics capital equipment market. Revenue in our Analytical instruments and medical devices business also increased to £39.4m, compared with £35.0m last year. Further details of our performance by product are given on pages 26–29.

Manufacturing technologies revenue

+11%

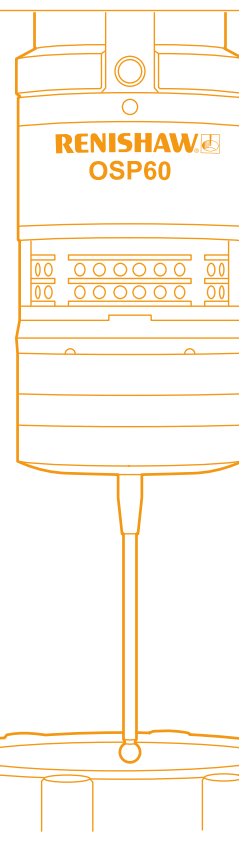

Revenue analysis by region

	2021 revenue at actual exchange rates £m	Change from 2020 %	2020 revenue at actual exchange rates £m	Underlying change at constant exchange rates %
APAC	274.8	+21	227.7	+23
EMEA	169.1	+1	167.2	+1
Americas	121.7	+5	115.3	+9
Total Group revenue	565.6	+11	510.2	+13

Operating costs

Our Fit for the Future initiative implemented last year resulted in actions which improved productivity and reduced our cost base. These included a resizing of the business, a restructure of our AM product line, and a focus on prioritising design projects to accelerate the market launch of significant products.

As a result, underlying labour costs (excluding bonuses and grants) were £208.2m this year compared to £225.8m last year, with an average headcount of 4,437 (2020: 4,797). This year's total labour cost (see note 3 to the financial statements) includes £1.0m of global job retention grant income (2020: £4.5m), all of which originated overseas this year, a £3.5m 'thank you' payment for employees to recognise their exceptional efforts during the pandemic, and performance bonuses totalling £13.2m (2020: £nil). Given the increase in demand in the second half of the year we have recruited over 300 manufacturing staff to ensure we have sufficient capacity to meet demand.

Certain other operating costs, such as travel and exhibitions, are around £6.3m lower this year compared to last year due to restrictions resulting from the pandemic. We expect these costs to increase as restrictions are lifted, although we do not expect travel to return to pre-pandemic levels as the use of online meetings has proven an effective tool for

many communications and is aligned with our environmental aims.

Production costs, as a % of sales, reduced by 1% to 35% (see note 4). This is the result of both cost reductions and improved manufacturing efficiencies.

Impairments of £4.7m have been recognised in the year, relating to investments, loans and finance leases with an associate company (see note 13 for further detail). No further significant asset impairments have been recognised this year, as a result of improving macroeconomic conditions and upward demand trends across most of our geographic areas and business units. In the previous year, we impaired £9.9m of capitalised development costs (aside from restructuring costs).

Research and development

We remain committed to our long-term strategy of delivering growth through the development and introduction of innovative and patented products. During the year we incurred research and development expenditure of £58.6m, compared with £66.6m last year (see note 4). This reduction is consistent with our expectations given the focus on flagship projects. We also incurred £18.0m (2020: £15.8m) on other engineering expenditure, to support existing products and technologies.

We have launched new products during the year, notably the FORTIS enclosed optical encoder which provides high-performance measurement in harsh environments, including machine tools and semiconductor wafer dicing. Details of other product launches can be found on pages 26–29.

Profit and tax

Adjusted profit before tax amounted to £119.7m compared with £48.6m in 2020, an increase of 146%. Statutory profit before tax was £139.4m compared with £3.2m in the previous year.

Items excluded from Adjusted profit before tax are as follows:

- £23.8m of restructuring costs in 2020 which have not repeated this year;
- gains of £23.0m from forward contracts deemed ineffective for cash flow hedging (2020: £21.6m loss); and
- third-party fees relating to the FSP of £3.2m (2020: £nil).

Further details of alternative performance measures are provided in note 28.

Adjusted profit before tax bridge

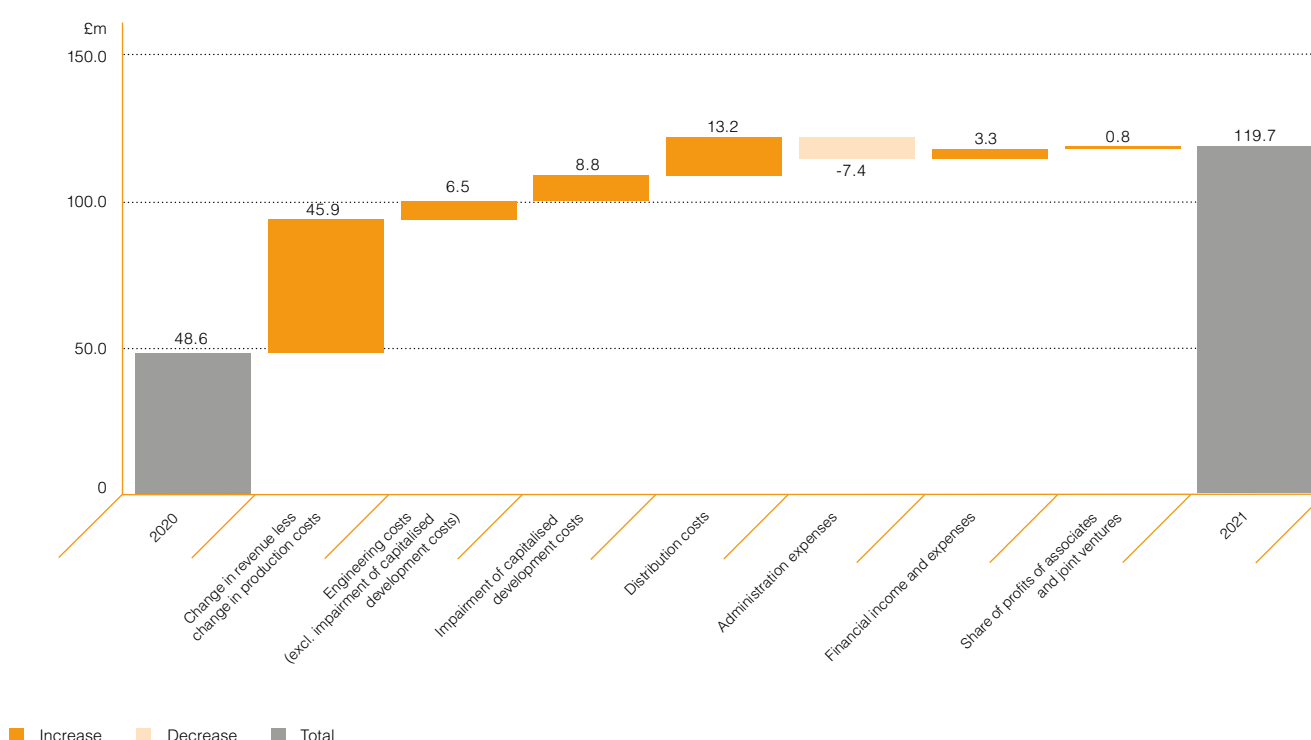

Financial review continued

Adjusted operating profit in our Manufacturing technologies business was £112.6m compared with £50.3m last year, while in our Analytical instruments and medical devices business, Adjusted operating profit was £5.9m compared with £1.4m last year. These improvements result from revenue growth and the reduced cost base described earlier.

The overall effective rate of tax was 20.1% (2020: 91.0%). We operate in many countries around the world and the overall effective tax rate is a result of the combination of the varying tax rates applicable throughout these countries. The reduction in the year-on-year rate is primarily due to the derecognition of deferred tax assets in 2020. Note 8 provides further analysis of the effective tax rate.

Cash and liquidity

We have achieved an improvement in our liquidity position during the year, with net cash and bank deposit balances at 30 June 2021 of £215.0m (2020: £120.4m). This is mostly a result of our strong trading performance and reduced levels of capital expenditure and dividends paid this year.

In line with our capital allocation strategy (see right), the chart below summarises our sources and uses of cash for the year, reconciling opening to closing cash and bank deposit balances.

We disclose details of 'severe but plausible' scenario forecasts used in our going concern and viability assessments on pages 113–114 and 44–45 and conclude that we have a reasonable expectation that we will retain a liquid position and be able to continue in operation for at least the next three years.

Consolidated balance sheet

Additions to property, plant and equipment and vehicles totalled £10.9m, of which £1.0m was spent on property and £9.9m on plant and machinery, IT equipment and infrastructure, and vehicles. The lower expenditure this year is in line with our expectations following significant infrastructure investments in recent years.

Within working capital, inventories increased to £113.6m from £105.5m at the beginning of the year, primarily as a result of the higher trading levels. We continue to focus on inventory management while remaining committed to our policy of holding sufficient finished goods to ensure customer delivery performance, given our short order book. Given recent global shortages, we have also increased safety stock levels of some critical components to mitigate the risk of supply chain disruption.

Trade receivables increased from £105.1m to £114.7m due to increased revenue and including a currency translation gain of £7.8m.

There was an improvement in debtor days to 61 at the end of the year, compared with 76 at the end of last year. We have also seen a reduction in the provision for expected credit losses, from 1.5% of gross trade receivables at 30 June 2020, to 0.3% at 30 June 2021, resulting from the economic recovery we are now experiencing across our regions.

Total equity at the end of the year was £703.3m, compared with £546.9m at 30 June 2020, primarily as a result of profit for the year of £111.5m and cash flow hedging reserve gains of £41.8m.

Capital allocation strategy

The Board regularly reviews the capital requirements of the Group, in order to maintain a strong financial position to protect the business and provide flexibility to fund future growth.

We have consistently applied our capital allocation strategy for many years. We are committed to investment in the R&D of new products, manufacturing processes and global support infrastructure in order to generate growth in future returns and to improve productivity while managing expenditure appropriate to trading conditions. This is evidenced in the year by continued investments in capital and R&D.

Sources and uses of cash

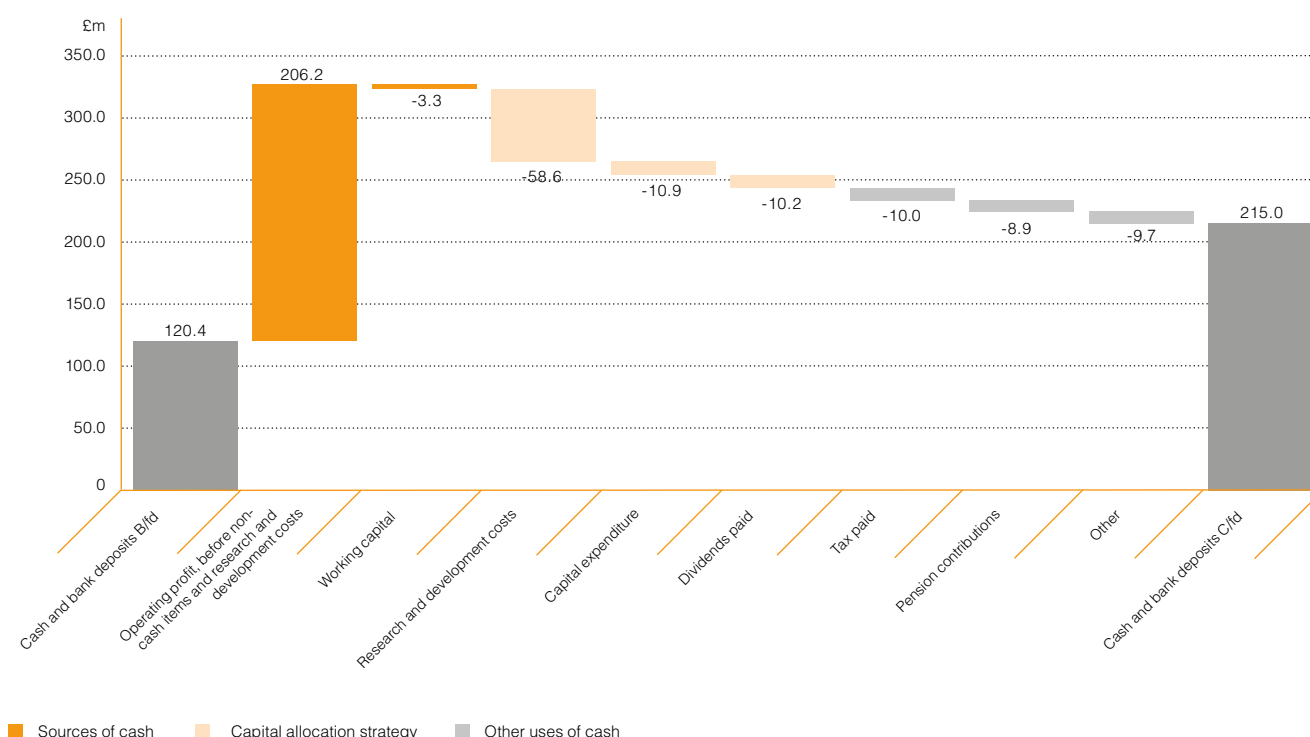

Actual and forecast returns, along with our strong financial position, support our progressive dividend policy, which aims to increase the dividend per share while maintaining a prudent level of dividend cover. In exceptional circumstances the Board may deem it appropriate to not pay a dividend. This was the case in 2020, where no final dividend was proposed as a result of global uncertainty arising from the COVID-19 pandemic.

Pensions

At the end of the year our defined benefit pension schemes, now closed for future accrual, showed a deficit of £23.7m, compared with a deficit of £64.9m at 30 June 2020. Defined benefit pension schemes' assets at 30 June 2021 increased to £231.4m from £188.6m at 30 June 2020, primarily as a result of strong investment performance.

Pension scheme liabilities decreased from £253.5m to £232.6m, on an IAS 19 basis (excluding the effect of IFRIC 14 and the asset ceiling). This primarily reflects the net effect of:

- an increase in the discount rate of the UK scheme;
- an increase in RPI for the UK and Irish schemes;
- an increase in CPI for the UK scheme; and
- a £14.3m reduction due to an adjustment discussed further below.

According to the terms of the current deficit funding plan, the Company is paying £8.7m each year into the scheme until 1 October 2023. The agreement will continue until 30 June 2031 and any outstanding deficit will be paid at that time. The agreement will end sooner if the actuarial deficit (calculated on a self-sufficiency basis) is eliminated in the meantime. The present value of the expected payments totalled £19.2m at 30 June 2021, relative to the net asset position of £3.3m. This has resulted in an additional £22.4m liability being recognised according to the asset ceiling and IFRIC 14.

In October 2020, the Trustees of the Renishaw Pension Fund ('the UK defined benefit scheme') notified the Company of a difference between the calculated estimate of liabilities in the scheme for administration purposes and for accounting purposes.

Differing legal interpretations of the Trust Deed and Rules were subsequently concluded by legal firms instructed by the Trustees and the Company, mostly relating to the periods over which revaluation and late retirement factors are applied, with significant differences in the financial impact noted. Consequently, in April 2021, the Trustees and the Company jointly instructed Queen's Counsel to opine on a legal interpretation of the Trust Deed and Rules that both parties would accept. This resulted in another interpretation of the Trust Deed and Rules which is now the accepted legal position, with a £14.3m reduction in liabilities calculated on this basis. This change in liability estimate in the year relates to benefits for some members payable in future years, and has been accounted for within the 'Remeasurement of defined benefit pension scheme liabilities' in the Consolidated statement of other comprehensive income and expense.

See note 22 for further details on employee benefits.

Treasury policies

Our treasury policies are designed to manage the financial risks that arise from operating in a number of foreign currencies, to maximise interest income on cash deposits, and to ensure that appropriate funding arrangements are available for each of our companies.

We use forward exchange contracts to hedge a proportion of anticipated foreign currency cash inflows and the translation of foreign currency denominated intercompany balances. There are forward contracts in place to hedge against our Euro, US Dollar and Japanese Yen cash inflows and to offset movements on Renishaw plc's Euro, US Dollar and Japanese Yen intercompany balances. We do not speculate with derivative financial instruments.

Most of these forward contracts are subject to hedge accounting under IFRS 9 'Financial Instruments'. The hedged item in these contracts is the revenue forecasts of Renishaw plc and Renishaw UK Sales Limited, and during the year these forecasts were increased due to the improved economic conditions, such that all forward contracts have passed hedge effectiveness testing in the year. Gains and losses which recycle through the Consolidated income statement as a result of contracts previously found to be ineffective are excluded from adjusted profit measures. See note 24 for further details on financial instruments and note 28 on alternative performance measures.

Earnings per share and dividend

Adjusted earnings per share is 132.0p compared with 51.0p last year, while statutory earnings per share is 153.2p compared with 0.4p last year.

We reinstated the dividend programme during the year and paid an interim dividend of 14.0 pence net per share (2020: nil) on 6 April 2021 and are pleased to propose a final dividend of 52.0 pence net per share in respect of the year (2020: nil).

Looking forward

We continue to see external market growth drivers that are creating opportunities for our business. These include global skills shortages, digitalisation, near-shoring and reshoring, sustainable manufacturing, population growth and increasing life expectancy. These opportunities support a core objective of investing in research and development to deliver patented and innovative products and processes, helping our customers improve efficiency and reduce both waste and cost. With these growth opportunities in mind, we have secured planning permission to increase production capacity at our Miskin site in South Wales, UK.

Thanks to our highly-skilled and committed people we have remained resilient throughout the pandemic and our financial position has strengthened further during the year. This, combined with our future opportunities and strategic objectives, gives us confidence in the long-term prospects of our business.

Allen Roberts

Group Finance Director

21 October 2021

Our principal markets

For almost 50 years we have worked closely with our customers across multiple markets to solve complex engineering and science challenges. Together we make it possible to create the products, materials and therapies that shape our world today and will continue to define our world in the decades to come and touch billions of lives.

From transport to agriculture, electronics to neurosurgery, our vision is to innovate and transform our customers' capabilities in manufacturing, science and healthcare through unparalleled levels of precision, productivity and practicality. In a world of increasingly scarce resources, this is especially important to help our customers who face the challenge of developing products and processes that are sustainable, that deliver higher levels of performance through increased efficiency, that make intelligent use of data, and are customised to suit individual requirements.

We therefore contribute to the development of a wide range of products (from smartphones to solar panels, jet engines to dental implants) and help address pressing real-world problems (such as food security, energy generation and degenerative diseases).

Our technology solutions help manufacturers to maximise production output, significantly reduce the time it takes to produce and inspect components, and to keep their machines running reliably. They also allow machine builders to manufacture highly accurate and reliable products. Within our Analytical instruments and medical devices segment, our products are designed to improve medical research and surgical procedures.

With businesses increasingly focused on their environmental impact and the need to reduce costs, our products also help customers reduce energy consumption and minimise waste, for example by reducing unproductive machine time, eliminating scrap components and reducing the total energy consumption needed to produce the same level of machined components.

We help customers make the most of our technology through expert sales and service support in 37 countries and 79 locations.

We list our principal markets and the specific key drivers of demand for our products within those markets on page 25.

There are also more generic market economic drivers that affect our business. These include:

- **energy costs** – rising energy prices mean energy consumers need products that help maximise production output; lower energy prices reduce investments by energy providers;
- **focus on reducing emissions and waste** – increased demand for high-performance products with ever tighter manufacturing tolerances and products that help minimise waste and rework;
- **global competitiveness** – increased focus on costs requires increased speed of operation and reduced scrap/rework;
- **global economic growth** – growth in key geographic markets and global trade affects demand in key sectors that we supply;
- **global pandemic** – reduced consumer spending on vehicles and restrictions on travel affects global demand for civil aircraft;
- **global skills shortages and rising labour costs** – increased investments in automation, robotics and user-friendly technology;
- **industry 4.0/smart factories** – demand for more digitalisation and data to inform manufacturing processes;
- **life expectancy increasing globally** – increased demand for healthcare products and continuing demand for consumer products;
- **near-shoring and reshoring** – global politics and trade tensions are driving investment in new localised manufacturing facilities; to be competitive in high labour cost markets requires automation and robotics;
- **population growth and rising incomes** – increased consumption in our principal markets;
- **requirements for better performing products** – increased investments in research and development and manufacturing capabilities; and
- **sustainable manufacturing** – increased attention to the environmental impact of manufacturing processes and total product life cycle.

We continue to reduce risk through the diversification of applications for our products, by expanding our offer in core markets, expanding our customer base and developing new routes to market.

A key focus is to bring measurement ever closer to manufacturing processes, to reduce material waste at source and minimise downstream problems, such as poor component fit, that are more expensive to rectify. We are also helping our customers to maximise the capabilities of existing metrology products through multi-sensor devices that reduce the requirement for dedicated equipment, and reduce floor space and energy consumption.

We are also making our products more accessible to a wider customer base by providing open architecture products that are compatible with a wide range of third-party software systems.

From transport to agriculture, electronics to neurosurgery, our vision is to innovate and transform capabilities in manufacturing, science and healthcare through unparalleled levels of precision, productivity and practicality.

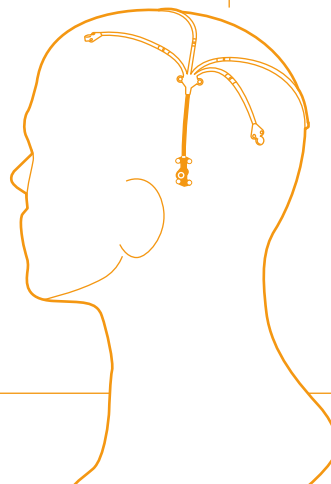

Aerospace



Aircraft are highly complex structures and their key assemblies rely on our products throughout the supply chain, including maintenance, repair and overhaul (MRO). Our products help with process control and post-process inspection during aircraft manufacture. Key drivers include more fuel-efficient engines, lighter components and pressure to reduce costs. We are also seeing more research into Net Zero aircraft. Despite the short-term effects of the COVID-19 pandemic, we still expect long-term growth in the civil aviation market, especially from short-haul aircraft in Asia.

Agriculture



The manufacture of many key components for high-end agricultural equipment is subject to process control using Renishaw products. The increasing use of automation within the sector is also benefiting our encoder line. There is increasing demand for food products due to a growing global population with rising disposable incomes, against a backdrop of climate change. This requires greater investment in machinery for intensive farming and new technology, including Smart Farming techniques (e.g. geomapping satellites) and automation, to increase yields and reduce environmental costs.

Automotive



Many key components in domestic and commercial internal combustion engine (ICE) vehicles are subject to process control using our products. Although there is reduced capital investment in ICEs, there are multiple opportunities for our products in the research and manufacture of hybrid and electric vehicle types. These also need precision parts, cost efficiencies and automated processes throughout the supply chain. Vehicle design life cycles are also reducing, driving more flexible manufacturing and measurement requirements.

Construction



From heavy earthmoving equipment to mineral analysis, Renishaw's products are used in a diverse range of construction industry applications. These include making large high-value components such as chassis, designing more reliable power plants with lower emissions, and materials identification in geological samples using our Raman spectroscopy systems. Key market drivers include the investment environment for infrastructure projects and skills shortages within a sector looking for more automation from equipment manufacturers. We are also seeing longer-term plans to switch to hydrogen fuel cells.

Consumer electronics



This fast-paced market demands flexible manufacturing systems that can adapt to shorter life cycles, yet still deliver high-quality, high-volume components. These are necessary for the high standard of fit and finish increasingly needed for home appliances and enclosures on products such as mobile devices, where we see a trend away from metal to glass and ceramic, which improves 5G signal reception. Rising labour costs are driving the increased use of automation, while 5G products need more complex integrated circuits. New resilient supply chains are being created to cope with emerging market demand and reduce risks in product supply following the pandemic and trade sanctions.

Healthcare



Our technologies are being applied to an ever-increasing number of applications within healthcare, including brain surgery, reconstructive surgery and dentistry. Life expectancy is increasing in both developed and developing markets, which is causing a rise in neurological disorders. So fast, precise surgical therapies are needed to reduce waiting times. Increased life expectancy and obesity in industrialised nations is also creating a significant increase in orthopaedic procedures requiring manufactured implants and devices. There is also a drive for more economical treatments, more patient-specific treatments, and safer procedures with reduced human error, increasing the demand for medical robots for precision positioning.

Power generation



Whether fossil fuels, civil nuclear or renewable energy, our products are used to control the production of key components including power transmission systems, bearings, generators and pumps. Key drivers include the manufacture of components for wind turbines and solar panels, an increasing focus on maximising the efficiency of machinery used in power generation, and increasing research into energy storage, especially in relation to electric vehicles.

Resource exploration



Equipment for oil and gas exploration must be manufactured to stringent safety standards, requiring accurate, cost-effective and traceable processes. The growth in the global population and increased urbanisation are driving long-term demand for fossil fuels. This is driving the exploration of new sources, often in more demanding terrains, and more research into optimal extraction from existing sites. There is also a focus on improving the efficiency of large diesel engines used in transport and resource exploration and extraction, which needs greater component accuracy.

Performance review

Manufacturing technologies (formerly Metrology)

Our markets

Our key markets include aerospace, automotive, consumer products and power generation.

 **Aerospace**
 ▶ Read more on page 25
 ▶ www.renishaw.com/aerospace

 **Automotive**
 ▶ Read more on page 25
 ▶ www.renishaw.com/automotive

 **Consumer electronics**
 ▶ Read more on page 25
 ▶ www.renishaw.com/electronics

 **Power generation**
 ▶ Read more on page 25
 ▶ www.renishaw.com/energy

Our products

 **Industrial Metrology**

 **Position Measurement**

 **Additive Manufacturing**

Market conditions

While the pandemic continues to affect some of our key sectors, primarily aerospace, we have seen a strong recovery in sales and orders for most of our Manufacturing technologies products in the second half of the year. We have seen the strongest recovery in APAC, with strong growth over the last year. We have also started to see early signs of renewed confidence in all our regions.

Strategy and performance

Across all our Manufacturing technologies product lines our vision is to enable the factories of the future with innovative technologies and expertise. We give our customers precision through products that give them accurate, intricate production processes to deliver higher performance and sustainability; productivity through products that give them higher process yields, faster cycle times and more automation; and practicality through products that are easy to use and have embedded knowledge and data analytics.

We continue to develop simplified software, including mobile and on-machine apps, for machine tool and CMM probing and gauging. We are also developing our own next-generation metrology software, with a focus on gauging and 5-axis metrology.

We are continuing to develop additional sensors to maximise the capabilities of existing metrology platforms through multi-sensor devices for our REVO system. This allows our customers to reduce the requirement for dedicated equipment which reduces floor space requirements and energy consumption.

To make our systems available to a wider base of customers, we are also broadening our distribution network for certain end user market solutions, including the Equator™ gauging system.

Performance

Overall, there was growth for our Industrial Metrology business. The pandemic has caused significant challenges, especially in the aerospace sector. However, we have experienced a strong global recovery in the second half of the year, which like many other manufacturers has led to supply chain challenges with global shortages in areas such as electronics components, aluminium and cardboard. Despite an increase in lead times for many of our products, we are better placed than many businesses due to our inventory management and the loyalty of our customer base.

We have seen a particularly strong recovery in China, based on general demand across multiple sectors. While there is significant investment in the production of hybrid and electric vehicles (EV), where there are multiple applications for our products, there is still investment into the manufacture of vehicles with ICE, albeit an upgrading of existing production capabilities to improve the efficiency of petrol engines rather than new lines. Despite the challenges within the aerospace sector, we continue to invest in long-term projects and we are seeing new market investment in our APAC region.

Industrial Metrology

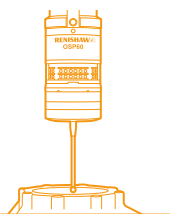

Product and commercial strategies

Our Industrial Metrology business comprises our CMM systems, machine tool probing, gauging, fixturing and styli product lines. A key focus is to help our customers bring measurement ever closer to manufacturing processes to reduce material waste at source and minimise downstream problems, such as poor component fit, that are more expensive to rectify. To achieve this, we continue to develop our range of probe systems and software for machine tools, to expand our range of easy-to-use flexible shopfloor gauges, and to make our equipment more compatible with third-party metrology software and, therefore, useful for more customers. We are therefore actively working with multiple software providers to support the integration of our 5-axis measuring systems for CMMs and gauging products.

At a product level, we are seeing market uptake of our NC4+ Blue laser tool setting system due to its improved metrology and compact size. The SPRINT™ scanning probe technology for machine tools is being adopted for growth applications for on-machine process control, including coatings on cylinder bores which aim to improve ICE efficiency, customised medical implants and freeform additively manufactured parts.

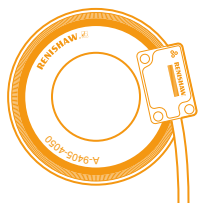

Position Measurement

Product and commercial strategies

The practicality of our products is a key focus for our Position Measurement business which comprises our optical encoders, laser encoders, calibration products, and magnetic encoders from our joint venture, RLS. We therefore aim to increase ease of installation and ease of use for all core hardware products and supporting technology, including improved diagnostic capabilities and software enhancements to improve the usability and features of our CARTO calibration software.

We continue to make significant R&D investments to develop the next generation of high-performance optical and laser encoders to meet market demands for ever higher resolution, accuracy and speed. A key focus is also to move into markets where we already have exposure with non-substitutional products. As an example, during the year we launched the FORTIS enclosed encoder for machine tools, a market we know well and where we have strong brand recognition.

Performance

All our encoder lines achieved record sales, primarily due to very positive demand from the semiconductor and microelectronics sectors. The pandemic has led to many people spending more time at home, for both work and leisure, leading to high demand for a range of electronic products including laptops, webcams, monitors, games consoles and supporting infrastructure for streaming and cloud-based services. Many EV and ICE vehicles also now use a high number of semiconductor chips for control systems, infotainment systems and digital dashboards.

During the year, our optical and laser encoder lines also benefited from the global investment in new mini-LED and micro-LED flat panel displays for brighter, more energy-efficient displays and large investments in EUV (extreme ultraviolet lithography) semiconductor processes to produce high volumes of smaller, faster and more power-efficient chips. The need for this new generation of chips is being driven by the rollout of 5G programmes and associated mobile devices.

With the critical nature of global chip supply now laid bare, individual nations are investing for self-sufficiency in semiconductor manufacturing, with notably the USA, China and Japan all indicating heavy investments to ensure future continuity of supply.

All the position encoders supplied by the Group also continue to benefit from the ongoing global drive towards industrial automation, including semiconductor processing and materials handling. This aims to increase capacity and flexibility, while reducing manufacturing lead times and costs.

As reported for our Industrial Metrology lines, component supply has been very challenging, but our long-term policy has been to hold stocks of key parts to mitigate against such risks and we are working closely with our supply chain to maintain continuity. Lead times to our customers have extended but are broadly in line with our competitors.

Additive Manufacturing

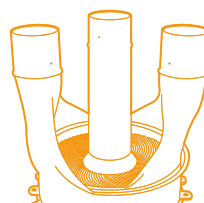

Product and commercial strategies

We are currently developing the next generation of AM machines with the aim to significantly reduce cost-per-part and make it easier to integrate AM systems with other manufacturing technologies as part of the general factory workflow. Many of the companies who are committed to using AM for volume production, operate in smart manufacturing/industry 4.0 environments, where connectivity to other systems and software is key. We are shifting to more open systems where our hardware and software platforms can easily connect with third-party software packages.

We continue to follow our strategy of simplification and focus, with our sales efforts concentrated on customers who need multiple system installations for volume production.

Performance

Sales of machines for industrial applications were lower than the previous year, but were consistent with our expectations following the restructuring of the business in 2020. Demand for the RenAM 500Q multi-laser system was affected by the pandemic and the consequent challenging market conditions, especially within the aerospace sector.

Together with a growth in the number of new market entrants, this has led to a global oversupply of AM systems and strong price competition, particularly for new accounts. With the benefits of our multi-laser systems for high-quality, productive metal part manufacture now being proven within key accounts, and the soon-to-be-available RenAM 500Q Flex system, we are well placed to benefit from an improvement in market conditions and the expansion of AM into new applications.

The new Flex systems will allow customers to rapidly switch between different materials during process development, while gaining the benefits of a multi-laser platform. It also means that it is then easier to transfer the process to volume manufacture on RenAM 500Q production systems.

Outlook

A detailed analysis of the key markets for our Manufacturing technologies can be seen in Our principal markets (page 24). We expect demand for our Position Measurement products to remain strong for at least the 2022 financial year with the same drivers for semiconductor, microelectronics and industrial automation. While the aerospace sector is still facing challenges, there is an expectation of recovery over the next two years and continuing investments in EV will also benefit our business. We also expect to see a continuing recovery in the key machine tool market. With rising global incomes and population expected to drive demand across all our key markets including civil aviation, agriculture, consumer electronics and power generation, a focus on sustainability and the efficient use of valuable resources will require metrology products that help drive efficiencies and minimise waste.

Performance review

Analytical instruments and medical devices

Our markets

Our key markets include craniomaxillofacial surgery, dental, neurological and materials analysis.



Craniomaxillofacial

- ▶ Specially configured AM systems to make patient-specific implants for facial reconstructive surgery, surgical guides and other orthopaedic applications.
- ▶ www.renishaw.com/cmfi



Dental

- ▶ Specially configured AM systems to make dental frameworks.
- ▶ www.renishaw.com/dental



Materials analysis

- ▶ Raman spectroscopy systems for advanced materials analysis, including biochemical changes associated with disease formation and progression.
- ▶ www.renishaw.com/raman



Neurological

- ▶ Neurosurgical robots, surgery planning software, drug delivery devices, and a range of consumable medical devices for a variety of diagnostic and treatment procedures.
- ▶ www.renishaw.com/neuro

Our products



Medical Dental



Neurological



Spectroscopy

Market conditions

While the pandemic and new import procedures in China brought challenges, our neurological and spectroscopy lines grew, with the second half of the year particularly strong. Confidence has returned to all our key markets. Funds for capital expenditure projects, which were postponed last year, are being released and we are seeing a good recovery in industrial and academic research budgets, which will benefit our spectroscopy and neurological lines.

Generally, our customer base is learning to cope with the conditions presented by the pandemic, hospitals have restarted non-essential surgeries and where travel restrictions do not allow in-person support, we have worked with customers to help them remotely.



Medical Dental

Product and commercial strategies

We are focused on our multi-laser RenAM 500Q systems with variants that are specially configured for the craniomaxillofacial (CMF) and dental markets. Our focus is also on customers in these markets who are committed to the integration of AM for volume production which requires multiple systems.

During the year we supplied the market with additively manufactured CMF implants, medical guides and dental structures produced on our own AM machines. We made these medical products at our Healthcare Centre of Excellence, based at our Miskin site in Wales, which operates under an ISO13485 quality management system. However, in August 2021 we decided that we will stop manufacturing such products on our own AM machines, and we will instead focus our Medical Dental business solely on sales of our RenAM 500 systems. All affected customers have been notified.

Performance

Our medical dental line had lower sales than 2020. This is because demand for additively manufactured CMF implants and dental structures continued to be affected by the pandemic due to the reduction in non-essential operations.

There were however good sales to some of our key accounts. This included multiple machines to Germany-based BEGO, one of the leading global companies in dental prosthodontics and implantology, and an experienced AM user. A key factor in this success is the productivity and part quality experienced by customers of our healthcare-configured RenAM 500Q systems.

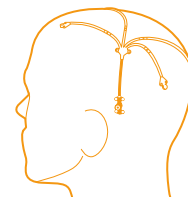

Neurological

Product and commercial strategies

Our vision is to deliver neurosurgical precision to enable innovative, life-enhancing therapies for increasingly prevalent neurological conditions. We do this by giving our customers:

- precision through products that give accurate device delivery and improved procedure safety;
- productivity through products that enable fast planning, automated placement and shorter surgeries; and
- practicality through products that assist with image-guided planning and predictable outcomes.

We are currently developing a common platform for drug delivery and deep brain stimulation (DBS), completing regulatory approval for drug delivery hardware and software, and are helping customers to progress multiple drug delivery clinical trials.

Our key commercial strategy is to simplify our approach and focus on strategic growth opportunities. We are mainly focused on a service and support model that helps pharmaceutical companies to develop a delivery strategy for trials that meets the requirements for both their patient population and candidate drugs.

Working with pharmaceutical companies is the approach we have chosen as each therapy development and delivery programme needs a bespoke approach to achieve the optimum delivery strategy. This model of working with pharmaceutical companies from pre-clinical trial to full market approval is proving to be the best approach to achieve a successful trial outcome and a market-approved therapy. This highlights how we are delivering on our purpose in the healthcare sector by working

together with our customers to transform tomorrow's medical therapies.

Performance

There was strong growth during the year for our neurological product line with record sales achieved, boosted by hospitals in key markets restarting elective surgery as COVID-19 patient numbers reduced. This included significant sales of consumable products for stereoelectroencephalography (SEEG) procedures used in the treatment of epilepsy. There were multiple sales of the neuromate® stereotactic robot, primarily for SEEG procedures, although robots are also being used for DBS and biopsy procedures. There remains underlying demand for robots in neurosurgery, which is still an emerging market.

During the year, we agreed to work with a major pharmaceutical company on a programme for a new candidate drug, validating the model that we have adopted for our drug delivery system.

With the emergence and rapid growth of potential gene therapy treatments for neurological diseases and disorders, there is significant interest in our delivery device. Our strong patent portfolio and many years' experience mean that we are well positioned to exploit opportunities in drug delivery, and we are very optimistic about the future growth of this business.

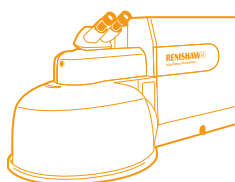

Spectroscopy

Product and commercial strategies

Our vision is to advance materials identification to allow our customers to gain a deeper understanding of materials and their interaction at a molecular level.

We do this by creating:

- precision spectroscopy products that give high-resolution sampling with sensitivity and specificity;
- productivity through systems that give automated analysis and rapid, reliable results; and
- practicality through products that are easy to set up and combine well with other analytical tools.

We are currently expanding the applications for the new Virsa™ fibre spectrometer which gives our customers the benefits of portability and in-field use, including process development and process monitoring, and research use for medical analysis. We are also making it easier to integrate Raman spectrometers with other analytical techniques, including scanning electron microscopy (SEM).

Our commercial focus includes the promotion of our inVia™ microscope, which was introduced at the end of the previous financial year. It is optimised for use in forensic laboratories for trace chemical analysis and designed to complement other analytical systems which are more commonly in use in forensics laboratories. We are also working hard to support customers to develop innovative biological detection techniques and expanding our range of educational webinars to reach new customers.

Performance

Our spectroscopy product line revenue grew during the year, with notable strength in EMEA sales. There were challenges with sales to China caused by the implementation of new processes for the importation of goods for the academic sector. This contributed to a strong order backlog which is carried into 2022.

As reported last year, the number of opportunities to apply our products to environmental processes continues to grow. For example, our Raman systems are now being used to detect microplastics. More water companies are using technology to analyse the quality of water and during the year we introduced a new Particle Analysis software module for our inVia system. This enables multiple spectra captured on filter paper to be automatically analysed and categorised by shape, size and chemistry. We are also part of MonPlas, an EU-funded project that recognises the potential health risks from micro and nanoplastics and aims to develop easy-to-use, low-cost technologies that can measure water quality against the 2019 EU drinking water directive.

Increasingly complex chemical formulations in everyday products, including polymer laminates in household products and complex medical products, are driving greater industrial use of Raman spectroscopy and imaging. For example, battery research continues to drive interest in the use of Raman spectroscopy, focused on the demand for improved performance, faster charging and lifetimes, especially the use of graphene, and other new battery materials.

During the year, there was also strong interest in and sales of our Virsa™ system for heritage applications, including the conservation, restoration and authentication of artefacts. Its portability, flexibility in sampling and high performance is very appealing to museums where analysis can take place on site. During the year we sold systems to internationally renowned organisations including The State Hermitage Museum in St Petersburg, Russia, and The Royal Institute for Cultural Heritage in Brussels, Belgium.

Outlook

Life expectancy is increasing in both developed and developing markets, meaning key drivers include the requirement for faster procedures to reduce waiting times, more economical treatments, more patient-specific treatments (e.g. implants) and safer, more automated procedures with reduced human error. All our Analytical instruments and medical devices product lines are well placed to deliver on these requirements.

The market for Raman spectroscopy continues to grow, with applications in an increasing number of areas, including green energy, environmental, biomedical, heritage and 2D materials. We have the spectroscopy products to meet these requirements.

In developing markets, levels of wealth have been increasing at a national and individual level, which is driving demand for higher-quality medical treatments, often requiring more technologically advanced products. Increased life expectancy on a global basis means greater incidences of degenerative neurological diseases, which will need surgical therapies, benefiting our neurological product line.

Risk management

Overview



In a year where risk management has been at the top of the agenda for many companies, it has been encouraging to see some of the changes we have made in this area making a difference in how we have responded to a challenging external environment.”

Jacqueline Conway
Chair of the risk committee

Our approach

The annual risk review process starts with strategic objectives and takes into account external risks and the global environment, as well as internal risks both at Group level and across our footprint.

As mentioned in the Chief Executive's review on page 8, there has been an increased focus on clarifying our strategy this year. We have therefore reviewed our risks within this context. This has not resulted in any major changes to our principal risks, as many of our underlying priorities remain the same.

This year we have introduced a formal risk appetite assessment as part of the annual risk process and the output from this exercise is shown in the table on pages 34–43. This has helped to continue to embed risk management in how we do business as it means we consider both the upside and downside of potential risks, which is critical in helping us achieve our strategic objectives.

How do we manage risk?

Last year we refreshed our approach to risk management, including how we identify our principal risks. These changes were well received by the Executive Committee and the Board, so we followed a similar approach this year.

How do we identify risks?

Our risk identification process comprises two stages:

1. Top-down process

Risk interviews are conducted by the Chair of the risk committee with senior managers. The output from these interviews is anonymised and aggregated to identify key themes, trends and any new or emerging risks.

2. Bottom-up process

Local risk reports are received from regional and product line managers. The results of these reports are aggregated to identify trends and any new principal or emerging risks.

The results from the top-down and bottom-up processes are then reviewed to form the basis of the first draft of principal risks. This draft is reviewed by the risk committee, which also considers the impact and likelihood for each risk. The resulting principal risks are then reviewed by the oversight bodies, notably the Executive Committee, Audit Committee and Board.

The table below sets out some of the key risk management activities undertaken throughout the year:

January/February	March/April	May/June	July–December
<p>Risk identification:</p> <ul style="list-style-type: none"> – Top-down interviews conducted with senior managers. – Bottom-up risk reports refreshed by regional and product line managers. – Consolidated outputs from the bottom-up and top-down process are shared with and considered by the risk committee. – The risk committee agrees draft principal risks. 	<p>Risk identification:</p> <ul style="list-style-type: none"> – Draft principal risks are reviewed by the Executive Committee / Audit Committee / Board. <p>Risk oversight:</p> <ul style="list-style-type: none"> – Risk appetite is considered by the risk committee. – Risk committee agrees a schedule of in-depth risk reviews for the year ahead. – Composition, membership and effectiveness of the risk committee is considered. 	<p>Risk reporting:</p> <ul style="list-style-type: none"> – Consultation with each principal risk owner to prepare draft wording for the Annual Report. – 'Severe but plausible scenarios' are modelled for the Viability statement to determine our viability over three years. 	<p>Risk monitoring:</p> <ul style="list-style-type: none"> – In-depth reviews by the risk committee, risk owners provide an update on their principal risks.

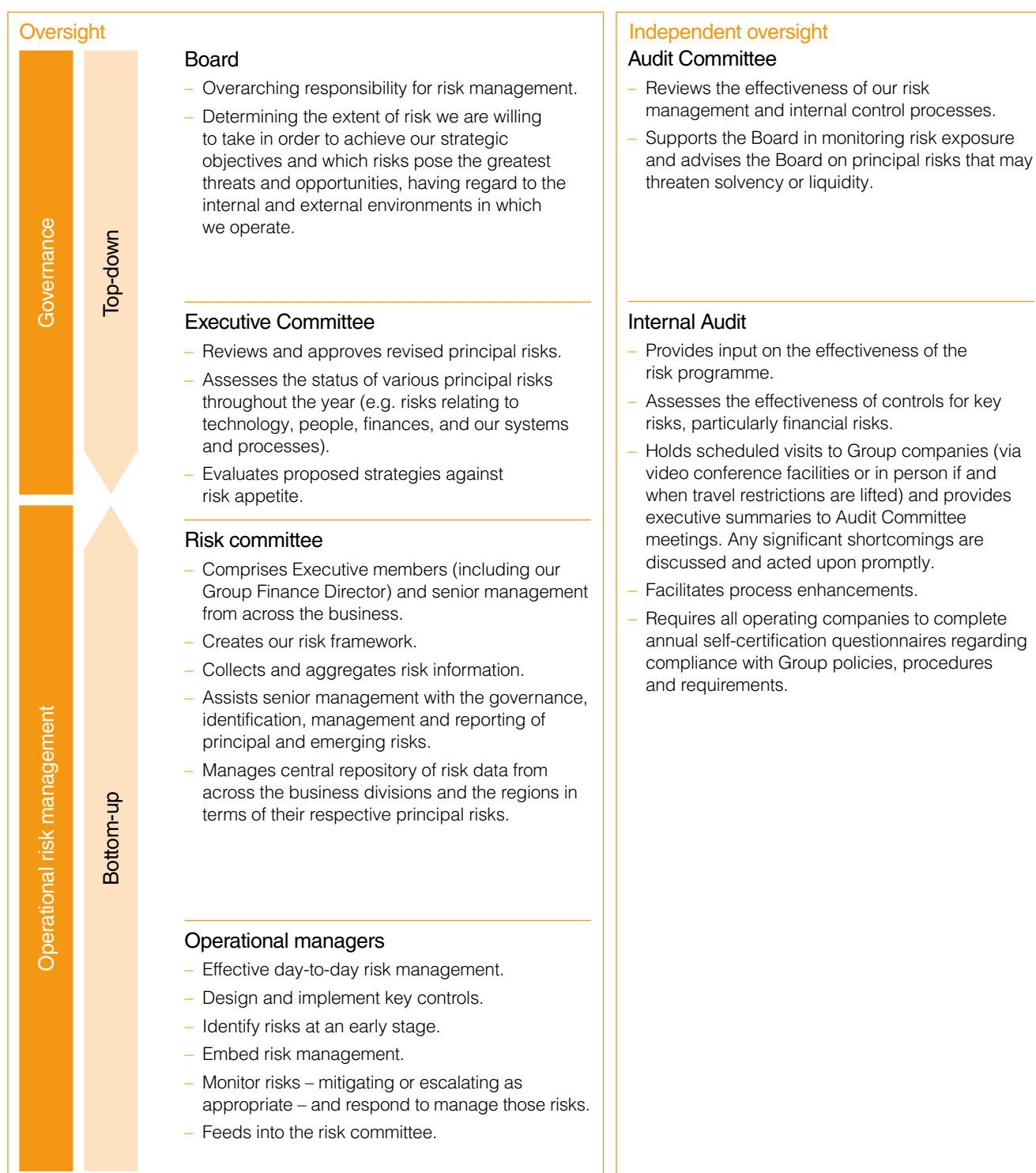

Risk management continued

Key themes in 2021

In a year where risk management has been at the top of the agenda for many companies, it has been encouraging to see some of the changes we have made in this area making a difference in how we have responded to a challenging external environment. Some of these risks, which are not standalone or principal risks, but are still considered significant from a strategic perspective, are shown below.

FSP

One of the most significant events during the year was the FSP. We launched the FSP on 2 March 2021 following the decision by the founders to sell their shareholding (about 53% of the issued share capital). The FSP concluded on 6 July 2021 as none of the proposals received satisfactorily met the interests of all stakeholders. There are inherent risks associated with any sale of a company, but these were managed in this case through the conduct of a robust process, and the clear criteria for sale announced at the start of the FSP. We also recognised that there were benefits in having gone through such a rigorous process, including greater focus on our key strategic objectives.

COVID-19

Despite having had a significant effect on the trading conditions in the second half of the last financial year and the start of the first half of this year, the impact of the COVID-19 pandemic has significantly decreased as the world has started to emerge from this crisis as a result of vaccination programmes.

Although its full long-term effects on the macroeconomic environment are not yet known, the impact of the pandemic on our principal risks has been much less significant this year than anticipated.

Brexit

Although not a standalone risk, Brexit was closely connected to some of our principal risks such as supply chain dependencies, industry fluctuations, and economic and political uncertainty. However, through planning and various mitigation actions (including previously establishing a new distribution warehouse in Ireland and managing inventory levels across the EU), business largely continued as usual following the end of the transition period. The Board continues to monitor any developments post-Brexit that may affect our strategy.

Data protection

As part of our ongoing commitment to achieving high standards of compliance with the General Data Protection Regulation (GDPR) and other data protection laws in the countries in which we operate, we have this year revised our internal and external privacy notices and created a new privacy policy with supporting personal information handling guidelines. Alongside this, we have rolled out global privacy and security training across many countries.

Cyber security

We have maintained our high level of vigilance in respect of cyber security threats. We continually monitor and adopt industry best practices, including investing in training and technologies to mitigate, detect and respond to this risk. We have met the ongoing requirements for remote working and the move to hybrid working across many of our locations with minimal disruption and, through training and communications, we have continued our efforts to raise awareness of cyber threats among our workforce.

Looking ahead

Emerging risks

In addition to our principal risks, we have identified additional emerging risks that are more uncertain in nature and which have the potential to develop over the coming years and affect our performance and ability to achieve our strategic objectives. These emerging risks may increase the impact and likelihood of our principal risks occurring.

To identify these risks, we reviewed the outcomes from the bottom-up reports to assess any emerging themes at a regional and divisional level. We are aware that these may increase or develop over time and so it is important to maintain a flexible and dynamic approach in monitoring these risks, which include:

- **climate change and environmental disasters**, which are becoming increasingly relevant across many of our principal risks. Although not considered a standalone risk in our principal risks, we recognise the importance of this global issue. We will continue to consider this in conjunction with our existing risk management processes. This includes monitoring this risk closely over the coming years to assess the mitigations in place within our Company as well as the external data and trends about the increasing risks posed by climate change.

Our work in connection with this emerging risk will also contribute to our alignment with the Task Force on Climate-related Financial Disclosures (TCFD) recommendations around governance, strategy, risk management, and metrics and targets.

- **changing work patterns** – it is not yet clear how changing working patterns, with an increased desire to shift to hybrid working as a result of the COVID-19 pandemic, will affect productivity and innovation.

Priorities for the year ahead

- Continue to monitor and assess emerging risks.
- Conduct in-depth reviews on all our principal risks across one or more of our governance bodies.
- Ongoing focus on trade-related disputes and the long-term impact of Brexit.
- Increase focus on the potential impact of climate change and how we can monitor this risk.
- Ongoing consideration of data protection and cyber security risks, particularly in light of the move to hybrid working.

Heatmap

The heatmap sets out the impact and likelihood scores for our principal risks. Details of these risks are set out in the table on pages 34 to 43.

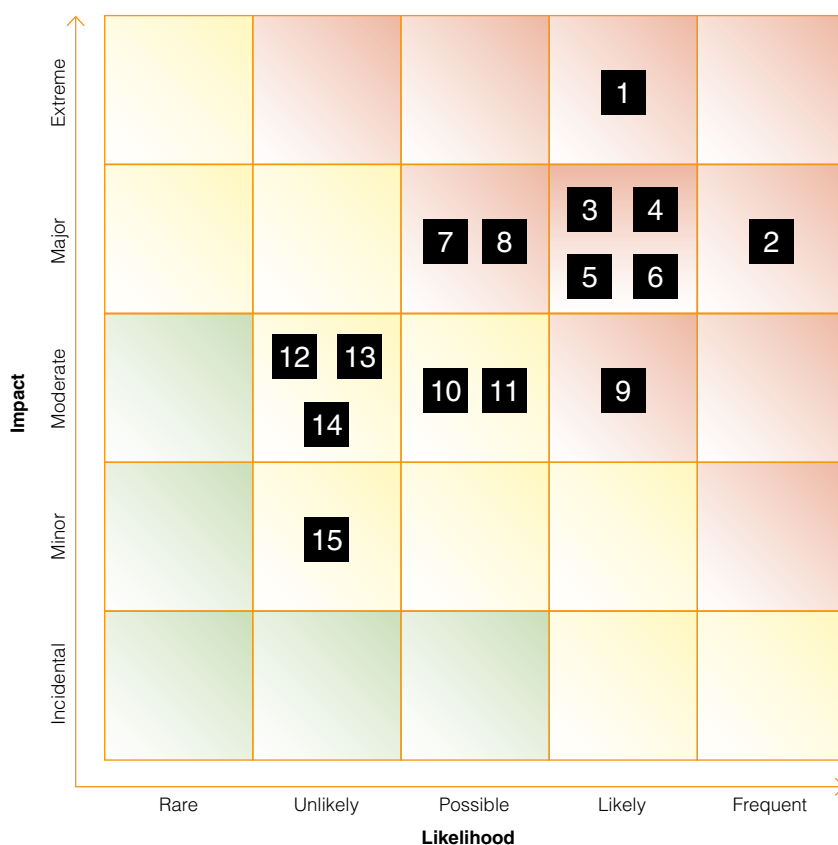

- 1 Industry fluctuations** – cyclical nature of demand in aerospace, automotive and consumer electronics
- 2 People** – loss of key talent and succession planning; failure to attract future leaders and/or skillsets that are in demand
- 3 Supply chain dependencies** – failure of a critical supplier, failure of supply from a key market like China or India
- 4 Innovation strategy** – failure to innovate to create new, cutting-edge, high-quality products
- 5 Economic and political uncertainty** – includes trade wars, increased protectionism, Brexit, global economic downturn
- 6 Route to market/customer satisfaction model** – move to systems integration and sale of capital goods
- 7 Capital allocation** – failure to properly allocate budget between core and emerging activities

- 8 Competitive activity** – failure to adapt to market and technological changes
- 9 Exchange rate fluctuations**
- 10 Loss of manufacturing output** – e.g. from natural disasters
- 11 IT transformation failure** – transition to future systems e.g. Microsoft Dynamics 365 causes major disruption; poor integration
- 12 Cyber** – attack on network or systems from internal or external threat
- 13 Pensions** – economic and social factors affecting the UK defined benefit pension scheme
- 14 Non-compliance with laws and regulations** – failure to comply with the laws and regulations in all of the markets in which we operate
- 15 Product failure** – failure to meet the appropriate quality standards

Changes over the last year



The key changes to the risks reported last year are as follows:

- **Loss of manufacturing output** – this risk has increased mainly as a result of external factors, such as the impact of the COVID-19 pandemic.
- **Fit for the Future** – this risk has reduced and is no longer considered a principal risk following our strong focus on cost management over the last year.

As mentioned on page 30, we have also conducted a risk appetite assessment this year. This has enabled us to assess whether we are taking the right amount of risk and to consider potential opportunities or the upside of certain risks, as well as mitigation strategies.



Principal risks and uncertainties

Trend

- Increased risk 
- Decreased risk 
- Stable risk 

Link to strategy

- SM** Sales & Marketing
- M** Manufacturing
- E** Engineering
- SS** Support Services
- P** Our People

Industry fluctuations			
Movement	Risk ranking	Appetite	Link to strategy
	1	HIGH	SM, M, E
Risk description		Potential impact	
<p>We are exposed to the cyclical nature of demand from aerospace, automotive and consumer electronics industries, which may be more severe if the downcycles of these key industries coincide.</p>		<ul style="list-style-type: none"> – Increased competition on prices. – Loss of market share. – Reduced revenue, profit and cash generation. 	
People			
Movement	Risk ranking	Appetite	Link to strategy
	2	MEDIUM	P
Risk description		Potential impact	
<p>Our people drive the success of our business. Inability to attract, retain and develop key talent at all levels of the organisation could mean we fail to successfully deliver on our strategic goals.</p>		<ul style="list-style-type: none"> – Loss of expertise, skills and specialist talent could affect delivery of objectives. – Poor retention and engagement could slow the delivery of our strategic objectives and product delivery. – Failure to develop future leaders, insufficient talent progression. – Loss of market share, reduced revenue, poor customer service and reduced profit. 	
Supply chain dependencies			
Movement	Risk ranking	Appetite	Link to strategy
	3	LOW	M
Risk description		Potential impact	
<p>We are exposed to the risk that some components we source are provided by single-source suppliers and we are vulnerable to an interruption in supply. While we duplicate key processes at more than one manufacturing location, significant disruption at a single site could compromise our ability to supply products to customers.</p>		<ul style="list-style-type: none"> – Inability to fulfil customer orders leading to a reduction in revenue and profits, and damage to reputation. – Failure to meet contractual requirements. – Increased costs of alternative sourcing or redesign. – Loss of market share. 	

Appetite**LOW**

Minimal risk exposure is considered the safest approach, which may mean lower returns.

MEDIUM

A balanced approach which carefully considers the risks and rewards.

HIGH

Greater risk tolerance, which may involve maximum risk for maximum return.

Risk owner

Chief Executive

Developments this year

COVID-19 has had a severe impact on many industries, but particularly the aerospace and automotive industries. However, the impact of this risk on the Group has been less significant than initially predicted.

What we are doing to manage this risk

- Closely monitoring market developments.
- Expanding our range in order to meet the demands of a number of different industry sectors and markets.
- Identifying and meeting the needs of emerging markets, for example in robotic automation.
- Maintaining a strong balance sheet with the ability to flex manufacturing resource levels.

Risk owner

Head of Group HR

Developments this year

Lockdown and remote working have affected employee availability, attendance, and engagement. This has had an adverse impact in some areas, but we have also seen a positive impact where employees have been able to engage and interact in new and different ways. Our employees have benefited from the ability of our systems and processes to support home working, as well as improvements in recruitment and retention, and development of talent.

What we are doing to manage this risk

- Establishing continuity plans to enable rapid adaptation to changing circumstances.
- Advancing our direct employee engagement through multi-media communications, promoting wellbeing, evolving feedback mechanisms, and further developing our inclusion strategy enabling equal opportunities to grow and develop.
- Continued investment in our STEM and Early Career programmes, as well as talent development and succession planning.
- Targeted approach to attract, reward, and retain our talent globally.

Risk owner

Head of Group Manufacturing

Developments this year



This risk has increased temporarily due to COVID-19 and the resulting global supply chain uncertainties faced by most manufacturing organisations. Manufacture of cables in India was adversely affected by the brief shutdown in that market. Once production resumed, this was sustained by the extraordinary efforts of local employees. Contingency plans were implemented in Ireland and with a third-party supplier to ensure ongoing supply. We have reviewed and increased inventory where appropriate.

What we are doing to manage this risk

- Continued focus on, and review of, sourcing of key components.
- Increase in buffer inventory.
- Cost-effective alternative sources of supply actively sought to reduce dependency on single-source suppliers.
- Specifications are reviewed and updated where necessary to facilitate alternative sourcing.



Principal risks and uncertainties continued

Trend

Increased risk	
Decreased risk	
Stable risk	

Link to strategy

SM Sales & Marketing	E Engineering	P Our People
M Manufacturing	SS Support Services	

Innovation strategy			
Movement	Risk ranking	Appetite	Link to strategy
	4	HIGH	E
Risk description	Potential impact		
Failure to innovate to create new cutting-edge, high-quality products, or failing to protect the intellectual property that underpins these products, which allows us to differentiate ourselves from our competitors. As a business driven by innovation, there is a higher risk with new ventures outside our traditional field of expertise where the science and engineering are less proven.	<ul style="list-style-type: none"> – Failing to meet customer needs for high-quality and complex products. – Loss of market share. – Reduced revenue, profit and cash generation. – Failing to recover investment in R&D. 		
Economic and political uncertainty			
Movement	Risk ranking	Appetite	Link to strategy
	5	HIGH	All
Risk description	Potential impact		
As a global business, we may be affected by political, economic or regulatory developments in countries that we operate in. This could include a global recession, Brexit, and US/China trade relations.	<ul style="list-style-type: none"> – Increased competition on prices. – Loss of financial and physical assets in a region. – Supply issues leading to failures to meet contractual obligations. – Reduced revenue, profit and cash generation. 		
Route to market/customer satisfaction model			
Movement	Risk ranking	Appetite	Link to strategy
	6	MEDIUM	SM
Risk description	Potential impact		
Inherent complexity in the move to systems integration and the sale of capital goods.	<ul style="list-style-type: none"> – Low capital efficiency – high people costs and low productivity. – Higher engineering and distribution costs. – Adversely affects customer satisfaction levels, revenue and profits. 		

Appetite**LOW**

Minimal risk exposure is considered the safest approach, which may mean lower returns.

MEDIUM

A balanced approach which carefully considers the risks and rewards.

HIGH

Greater risk tolerance, which may involve maximum risk for maximum return.

Risk owner

Executive Chairman/Director of Group Technology

Developments this year

Remote working has had a minor impact on innovation and project delivery. We have seen slight delays in some flagship projects.

What we are doing to manage this risk

- R&D projects are better prioritised and rationalised and regularly reviewed against milestones. Flagship projects are receiving greater focus from management and the Board.
- Medium to long-term R&D strategies are monitored regularly by the Board and the Executive Committee.
- Market developments are closely monitored and product development is based on input from customers.
- Patent and intellectual property protection are core to new product development.

Risk owner

Chief Executive

Developments this year

COVID-19 has had a severe impact across the globe from a health and economic perspective. Developments relating to US/China relations, and supply chain issues following Brexit, have also affected the business to varying degrees during the financial year.

What we are doing to manage this risk

- Monitoring external economic and commercial environments and identifying relevant headwinds.
- Maintaining sufficient headroom in our cash balances.
- Increase in buffer inventory.
- Closely monitoring all markets in which we operate.

Risk owner

Chief Executive

Developments this year



COVID-19 gave us an opportunity to review and refine our approach to the sale of capital goods. We have now streamlined our product portfolio and are working with third parties to streamline our existing sales network.

What we are doing to manage this risk

- Closely monitoring customer feedback.
- Reviewing our strategy for this area of the business.
- Collaborating with complementary third parties.
- Adopting new approaches to the sale of capital goods.



Principal risks and uncertainties continued

Trend

Increased risk	
Decreased risk	
Stable risk	

Link to strategy

SM Sales & Marketing	E Engineering	P Our People
M Manufacturing	SS Support Services	

Capital allocation			
Movement	Risk ranking	Appetite	Link to strategy
	7	MEDIUM	E
Risk description	Potential impact		
Failure to properly allocate budget between core and emerging activities.	<ul style="list-style-type: none"> – Investing in declining or less profitable areas at the expense of more profitable and strategically important areas. – Reduced profits. – Loss of market share. 		
Competitive activity			
Movement	Risk ranking	Appetite	Link to strategy
	8	LOW	All
Risk description	Potential impact		
Failure to adapt to market and/or technological changes.	<ul style="list-style-type: none"> – Reduced revenue, profits and cash generation. – Loss of market share. – Erosion of prices. – Loss of reputation as a leader in innovation. 		
Exchange rate fluctuations			
Movement	Risk ranking	Appetite	Link to strategy
	9	MEDIUM	SM
Risk description	Potential impact		
<p>Due to the global nature of our operations, with over 90% of the revenue generated outside the UK, we are exposed to volatility in exchange rates that could have a significant impact on our results.</p> <p>We are exposed to exchange rate risks, including currency cash flow, currency translation risk and the currency risk on intercompany balances.</p>	<ul style="list-style-type: none"> – Significant variations in profit. – Reduced cash generation. – Increased competition on product prices. 		

Appetite**LOW**

Minimal risk exposure is considered the safest approach, which may mean lower returns.

MEDIUM

A balanced approach which carefully considers the risks and rewards.

HIGH

Greater risk tolerance, which may involve maximum risk for maximum return.

Risk owner

Group Finance Director

Developments this year

We have continued to successfully ensure that our expenditure is controlled, including the prioritisation of flagship projects and monitoring labour costs versus target for all areas of the business. In the first half of the year, we finalised the rightsizing activities as part of our Fit for the Future initiative.

What we are doing to manage this risk

- Defining, prioritising and developing strategies for all core and emerging areas of the business.
- Greater scrutiny of all expenditure, including regular reporting on labour costs and capital expenditure.
- Regular reporting of cash balances.
- Tracking of performance objectives including regular reporting on flagship project progress.

Risk owner

Chief Executive

Developments this year

COVID-19 has accelerated business change in many areas and we have seen technology requirements developing more quickly.

What we are doing to manage this risk

- We are diversified across a range of products, industries and geographies.
- Closely monitoring market developments, particularly across our core product areas.
- Local sales and engineering support to quickly identify changing local needs.
- Strong historic and ongoing commitment to R&D investment to continue to build our product portfolio (see page 122 for details of R&D expenditure).

Risk owner

Group Finance Director

Developments this year



Sterling has strengthened against our major trading currencies, particularly against the US Dollar and Japanese Yen. Ongoing uncertainty caused by economic conditions and the impact of the pandemic could give rise to further volatility.

What we are doing to manage this risk

- Rolling forward contracts for cash flow hedges in accordance with Board-approved policy.
- One-month forward contracts to manage risks on intercompany balances.
- Currency pricing reviews with some large customers.
- Tracking of overseas net assets value compared to the market capitalisation.
- Obtaining input from external sources including our banks.



Principal risks and uncertainties continued

Trend

- Increased risk 
- Decreased risk 
- Stable risk 

Link to strategy

- SM** Sales & Marketing
- E** Engineering
- P** Our People
- M** Manufacturing
- SS** Support Services

Loss of manufacturing output			
Movement	Risk ranking	Appetite	Link to strategy
	10	LOW	M
Risk description		Potential impact	
<p>Manufacturing output can be adversely affected by factors including environmental hazards, technical delays or outages, plant or equipment failure, inadequate resourcing levels, or factors affecting the workforce such as a pandemic.</p>		<ul style="list-style-type: none"> – Inability to fulfil customer orders leading to a reduction in revenue, failure to meet contractual requirements and damage to reputation. – Increased costs of alternative sourcing or redesign. – Impact on maintenance of buffer inventory. – Loss of market share. 	
IT transformation failure			
Movement	Risk ranking	Appetite	Link to strategy
	11	LOW	All
Risk description		Potential impact	
<p>The upgrade of our IT systems to Microsoft Dynamics 365, to remove legacy systems and ensure our business is better integrated, could impact our business if there are major technical issues, or if it is poorly integrated. This risk could also result in problems if there are significant delays to the programme or it runs significantly over budget.</p>		<ul style="list-style-type: none"> – Major disruption to our systems (including our financial and HR systems) causing delay to our operations. – Affect our ability to process or issue invoices and customer orders, or to procure goods and services. – Increased costs, including to fix technical issues and restore or upgrade other affected systems. – Project delay would leave us supporting legacy systems for longer than desired. 	
Cyber			
Movement	Risk ranking	Appetite	Link to strategy
	12	LOW	All
Risk description		Potential impact	
<p>External and internal threat which could result in a loss of data including intellectual property, or our ability to operate our systems which could severely affect our business.</p>		<ul style="list-style-type: none"> – Loss of intellectual property and/or commercially sensitive data. – Inability to access, or disruption to, our systems leading to reduced service to customers. – Financial loss and reputational damage. – Impact on decision-making due to lack of clear and accurate data, or disruption caused by the lack of service. 	

Appetite**LOW**

Minimal risk exposure is considered the safest approach, which may mean lower returns.

MEDIUM

A balanced approach which carefully considers the risks and rewards.

HIGH

Greater risk tolerance, which may involve maximum risk for maximum return.

Risk owner

Head of Group Manufacturing

Developments this year

Our manufacturing division has responded well to the pandemic across all markets, although the relatively short notice of a lockdown in India did have an impact on the supply of cables across the Group.

What we are doing to manage this risk

- Duplication of high-dependency processes such as component manufacturing and finishing, electronic printed circuit board assembly, and microelectronics assembly across multiple manufacturing locations.
- Ensuring we have flexible manufacturing capacity and sufficient resilience across our manufacturing sites.
- Standardised approaches to assembly, annual risk assessments and business continuity planning.
- Reviewing and maintaining business interruption and other insurance cover.

Risk owner

Director of Group Operations

Developments this year

In the short term, remote working has had an impact on the ability to meet milestones and carry out appropriate testing. However, these delays are expected to be made up for in the longer-term timeframe of the project.

What we are doing to manage this risk

- Risk assessments carried out for all key systems likely to be affected by the upgrade.
- A clear roadmap with measurable milestones.
- Assigning project managers who have clear oversight of the project and any issues.
- Promptly identifying and dealing with any significant issues.

Risk owner

Director of Group Operations

Developments this year



With remote working, we have had to increase vigilance and awareness of potential cyber risks. We are continuing to see attempted phishing attacks but are managing these well.

What we are doing to manage this risk

- Substantial resilience and back-up built into our systems which are continuously updated in line with current threats and industry best practice.
- Cyber risks and security are regularly discussed at Board meetings.
- Physical, logical and control measures are deployed to protect our information and systems, and external penetration testing is conducted as appropriate.
- Regular security awareness training is conducted, including in relation to the specific risks associated with remote working.



Principal risks and uncertainties continued

Trend

Increased risk	
Decreased risk	
Stable risk	

Link to strategy

SM Sales & Marketing	E Engineering	P Our People
M Manufacturing	SS Support Services	

Pensions			
Movement	Risk ranking	Appetite	Link to strategy
	13	LOW	P
Risk description		Potential impact	
<p>Investment returns and actuarial assumptions of our defined benefit schemes are subject to economic and social factors outside our control.</p>		<ul style="list-style-type: none"> – Any deficit may require additional funding in the form of supplementary cash payments to the plans or the provision of additional security. – Significant management time. – External support costs. 	
Non-compliance with laws and regulations			
Movement	Risk ranking	Appetite	Link to strategy
	14	LOW	All
Risk description		Potential impact	
<p>We operate in a large number of territories and in some highly-regulated sectors. We are subject to a wide variety of laws and regulations, including those relating to anti-bribery, anti-money laundering, sanctions, competition law, privacy, health and safety, product safety, and medical devices.</p> <p>There is a risk that somewhere in the Group we may not be fully compliant with these laws and regulations.</p>		<ul style="list-style-type: none"> – Damage to reputation and loss of future business. – Potential penalties and fines, and cost of investigations. – Management time and attention in dealing with reports of non-compliance. – Inability to attract and retain talent. 	
Product failure			
Movement	Risk ranking	Appetite	Link to strategy
	15	LOW	E, M
Risk description		Potential impact	
<p>The quality of our products could be adversely affected by internal threats, such as inadequate quality management procedures or external threats such as substandard resourcing from third-party suppliers.</p> <p>This risk is particularly notable in our neurological products, where failure could result in significant personal injury claims.</p>		<ul style="list-style-type: none"> – Damage to reputation. – Claims, including personal injury. – Potential penalties and fines, and cost of investigations. – Inability to fulfil customer orders leading to a reduction in sales. 	

Appetite**LOW**

Minimal risk exposure is considered the safest approach, which may mean lower returns.

MEDIUM

A balanced approach which carefully considers the risks and rewards.

HIGH

Greater risk tolerance, which may involve maximum risk for maximum return.

Risk owner

Group Finance Director

Developments this year

- Strong asset growth (net of scheme funding and pensions payments) of £33.8m.
- A change in the estimate of benefits for some members of the UK defined benefit pension scheme has resulted in a reduction in scheme liabilities. See note 22 for further details.

What we are doing to manage this risk

- Recovery plan for the UK defined benefit scheme implemented in June 2019 with the aim of funding to self-sufficiency by 2031.
- Active engagement with the Trustees on investment strategy.
- The Trustees operate in line with a statement of investment principles.
- The Company and Trustees seek appropriate independent professional advice when necessary.

Risk owner

General Counsel & Company Secretary/Director of Renishaw Neuro Solutions

Developments this year

The forum previously established to focus on high-risk areas including competition law, anti-bribery, and sanctions, has continued to meet during the year. We have reviewed our current policies and have promoted communication and training for our employees.

What we are doing to manage this risk

- Whistleblowing hotline available for use by all employees.
- Regular compliance training for all employees.
- Controls in place to mitigate some of the risks (including insurance cover), and audits conducted to review some of these controls.
- Implementation of a global GDPR programme (and its equivalent in non-EU countries).

Risk owner

Director of Corporate Development/Head of QA RA & Clinical Affairs

Developments this year

The pandemic limited the ability of our engineers to conduct on-site product assessments for customers.

Where the use of the neurosurgical robot has continued during the pandemic, servicing and surgical support has continued to be provided.

The risk of failure of a new or existing product has not increased this year.

What we are doing to manage this risk

- Rigorous internal product development and testing procedures (during development, manufacturing and release) to international standards where applicable, to ensure high levels of quality assurance.
- Extensive interaction with customers and regulators to obtain and address feedback.
- Regular monitoring of third-party suppliers to ensure incoming parts and sub-contract activity meet requirements.
- Liability is limited by our terms and conditions of sale and we have liability insurance in place. For clinical studies, we have separate trial insurance in place.

Viability statement

During the year the Directors have assessed our prospects and viability, in accordance with the UK Corporate Governance Code. This assessment took account of our current position and principal risks, and the details of the assessment and the conclusion reached are set out opposite.

Context

In making the assessment, the Directors considered the following factors that they felt provided important context.

Financial resources – we have significant financial resources, with cash balances and bank deposits at the start of the viability assessment period of £215.0m. We have a strong history of creating cash for the business, with growth funded through cash reserves since we listed in 1984. The only external source of finance included in the viability assessment is the existing property mortgage in Japan (see note 21 on page 131), which is assumed to be repaid in full in the assessment period. We have no debt covenants.

Business model and markets – our business model includes designing and manufacturing products ourselves, giving us the flexibility to respond to customers' needs and the control over where we direct our manufacturing resource. We can also direct our sales and marketing resources where needed, should market trends and conditions change. In addition, we are also diversified over a range of markets, as explained on page 24.

Business planning – our business planning process uses a top-down approach (the 'corporate view') as well as detailed forecasts from both our product groups and our sales regions, to ensure a range of perspectives are reviewed. External sources of information, such as market trends and economic growth rates, are also used in our business planning process.

Risk management – we have a robust risk assessment and management process, as set out on page 30. As we explain in the Scenarios section below, the crystallisation of our principal risks have been considered in the viability assessment.

Impact of COVID-19 – although the COVID-19 pandemic still poses a significant risk to our people and the communities we operate in, we do not feel that it has had a severe impact on our prospects, our business plans nor on our financial resources. The response to outbreaks has changed significantly since the start of the pandemic and a global vaccine programme is underway. While we expect the pandemic to have an effect on macroeconomic conditions, we do not expect to see a repeat of the widespread lockdowns experienced concurrently in many countries in 2020.

Assessment period

The Directors used a three-year period, to the end of October 2024, in making their viability assessment. While a five-year business plan has been prepared, the Directors feel that a three-year period is more appropriate given our short order book and to give greater certainty over the forecasts and scenarios used in the assessment.

Scenarios

Six scenarios were used in the assessment, to model the effects on our viability of 'severe but plausible' scenarios. A base scenario was determined, as explained below, and then additional factors were added to this base as follows.

Base scenario – this takes the pessimistic revenue forecast from our business plan, with overheads, capital expenditure, and other cash outflows aligned to the optimistic revenue forecast from our business plan. Essentially, this means continuing to plan for the growth in our business plan, including the costs that would need to be incurred in earlier years to achieve revenue growth in the latter years, while assuming that revenue growth is at the lowest end of our corporate view. These pessimistic revenue forecasts are used as the 'highly probable' revenue forecasts in hedge accounting. For context, revenue in the first year of the base scenario is a small increase over 2021's revenue of £565.6m.

The other five scenarios then took the base scenario ('scenario 1') and considered the further effect of:

- 2) supply-chain disruption causing a loss in revenue, due to not being able to fulfil all orders, and some permanent loss of customers if this disruption caused them to move to our competitors
- 3) industry fluctuations and/or macroeconomic conditions causing revenue to significantly reduce
- 4) supply-chain disruption occurring at the same time as the industry fluctuations and/or macroeconomic conditions, combining scenarios 2 and 3
- 5) industry fluctuations and/or macroeconomic conditions causing revenue to significantly reduce, and also causing a significant deterioration in debtor days
- 6) supply-chain disruption and economic uncertainty result in a significant rise in material costs, and therefore a fall in gross margin

This modelling showed positive cash and bank deposit balances throughout the viability window for all scenarios, except for scenarios 4 and 5. In these, the models showed negative cash balances from June 2024 and October 2023 respectively. These scenarios were built from a base scenario where overheads, capital expenditure and other cash outflows were based on the 'optimistic' business plan, and therefore continued to increase despite revenue reductions. We therefore updated the modelling for plausible mitigating actions in scenarios 4 and 5, as explained below.

In scenarios 4 and 5, the risks were assumed to occur in the first year of the assessment period, and so in our updates we maintained overheads in years two and three from their first-year levels. We also reduced capital expenditure and dividends in years two and three, with these three mitigating actions all being considered by the Directors to be realistic actions that could be taken. These levels of capital expenditure would be sufficient to fund the planned IT infrastructure upgrades as well as supporting our existing manufacturing facilities and essential capital maintenance. In these revised scenarios, cash and bank deposit balances were positive throughout the three-year viability period.

For our other principal risks, no further separate scenarios were modelled. For risks such as People, Innovation strategy, and Capital allocation, the Directors felt that if these risks crystallised they would result in the restriction of longer-term growth rather than having a significant financial effect in the medium term. For other principal risks, the Directors considered that the existing scenarios sufficiently modelled a range of outcomes, including what would happen if multiple risks crystallised at the same time, and that the outcomes of other risks crystallising would be no worse than the existing scenarios.

Emerging risks of climate change and changing work patterns have also been reviewed by the Directors when considering the impact and likelihood of our principal risks crystallising.

Outcomes, mitigating actions and upsides

As explained above, the scenarios demonstrated that should the Group experience 'severe but plausible' conditions in the period to October 2024, positive cash and bank deposit balances can be maintained throughout the period. As a highly-vertically integrated business that typically funds future growth through using cash reserves, the Group has a range of mitigating actions that it can take in response to challenging conditions. In addition, the Directors considered how the business had responded positively to the COVID-19 pandemic as an example of the resilience and responsiveness of the Group.

In making their viability assessment, the Directors also considered the strong demand currently being experienced, and that the pandemic has accelerated trends such as digitalisation, near-shoring, and remote working, which the business is well placed to benefit from.

Conclusion

Based on this assessment, incorporating a review of the current position, the scenarios, our principal risks and mitigation, the Directors have a reasonable expectation that the Group will be able to continue in operation and meet its liabilities as they fall due over the period to 30 October 2024. In assessing the Group's viability over the next three years, it is recognised that all future assessments are subject to a level of uncertainty which increases for the latter part of the assessment period and that future outcomes cannot be guaranteed or predicted with any certainty.

Managing our resources and relationships

How we engage with our stakeholders

We have summarised our stakeholder relationships below, and have set out on pages 56–57 how we have considered our stakeholders when making important decisions (our 'Section 172 statement').

Our stakeholders		
<h3>People</h3>	<h3>Customers</h3>	<h3>Suppliers</h3>
<p>Why we engage</p>	<p>Why we engage</p>	<p>Why we engage</p>
<p>Attracting, retaining, and motivating our people is vital to our success, so that we have the right skills and knowledge in our business.</p> <p>We also need to hear how our people are feeling in terms of wellbeing, and to ensure that we are providing a safe place to work.</p>	<p>To fulfil our purpose, it is vital that we understand our customers' needs and challenges. Doing so means that we can then support them in transforming their own capabilities in manufacturing, science and healthcare.</p>	<p>Having a robust supply chain of high-quality, safe and ethical raw materials is important to our success as a manufacturer.</p> <p>We also need to have strong relationships with our suppliers to help us meet our customers' evolving needs and changing demands.</p>
<p>How we engage</p>	<p>How we engage</p>	<p>How we engage</p>
<ul style="list-style-type: none"> – Works Forums. – Business updates on Channel R, our in-house video channel. – Regular subsidiary and divisional meetings. – Diversity & Inclusion group. – Chief Executive 'Teams' calls following the FSP announcement. 	<ul style="list-style-type: none"> – Regular calls between our leadership and senior management teams, and those of our key customers. – Meetings and discussions at trade shows and conferences. – Webinars and online workshops. – Smart Manufacturing Ambassador programme on social media. 	<ul style="list-style-type: none"> – Regular calls and meetings between our purchasing teams and our suppliers. – Purchasing teams located in key locations for working with suppliers, including China. – Supplier audits and performance reviews.
<p>Actions</p>	<p>Actions</p>	<p>Actions</p>
<ul style="list-style-type: none"> – Provided a COVID-safe working environment, with regular employee testing. – 'Thank you' payment made to all employees in January 2021. – Dedicated FSP pages on our intranet site, with written Q&As. 	<ul style="list-style-type: none"> – Mitigated the potential disruption from Brexit by holding more finished goods in the EU. – Supported our sales subsidiaries to continue operating safely throughout the COVID-19 pandemic and provide local support. – Continued to invest significantly in R&D. 	<ul style="list-style-type: none"> – Increased safety stocks of certain key components. – £119.5m spent with suppliers during the year. – Average payment days to UK suppliers of 47 days.
<p>► Read more on pages 48–49</p>	<p>► Read more on page 50</p>	<p>► Read more on page 51</p>



Communities

Why we engage

Acting in a responsible way is important to us, and we want to make sure that we have a positive influence on the communities close to where we operate.

How we engage

- Educational outreach work, including virtual workshops, led by four full-time members of our outreach team.
- Employee volunteering.
- Donations, including providing equipment.
- Active membership of trade associations and research centres.

Actions

- £0.2m donated in the year.
- Held 112 online events and engaged with more than 5,000 students.
- In June 2021, the Board approved a new educational centre to open in Autumn 2021 at our Gloucestershire head office.

► Read more on page 52



Shareholders

Why we engage

We recognise the trust that our minority shareholders have placed in us, and aim to provide sustainable long-term growth in return.

How we engage

- Webcasts to present our interim and annual results, including Q&A sessions.
- Feedback received at and after the AGM.
- Dedicated email inbox for shareholders to submit questions to before the AGM.
- Remuneration policy consultation process conducted with a number of our key shareholders, led by Chair of the Remuneration Committee.

Actions

- Reinstated the dividend programme, with an interim dividend paid in April 2021 and a final dividend of 52.0p per share proposed.
- Remuneration policy implemented following consultation with shareholders.

► Read more on page 53



Planet

Why we engage

To deliver long-term value in a world of increasingly scarce resources, we need to minimise the impact our business has on the environment.

How we engage

- Interaction with customers to understand their challenges in manufacturing in a world of increasingly scarce resources.
- Review and monitoring of our emissions, waste output, and energy consumption.

Actions

- Reduced GHG emissions per £m of revenue.
- Developing our new Net Zero strategy, to be launched in 2022.

► Read more on page 54

Managing our resources and relationships continued

People

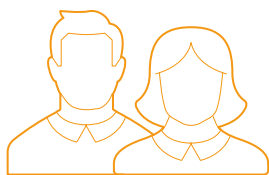

This year has been exceptionally challenging for our people due to the pandemic, and we are proud of how everyone has pulled together and responded. Nevertheless, those challenges have given us the opportunity to accelerate some of our work, such as developing more flexible working arrangements. The launch of our updated Group strategy in the year was also an opportunity to engage with our people across the business and to demonstrate that they are at the heart of our success.

Developing and motivating our people

We introduced Workday, our HR system, into more of our overseas locations this year, and also launched our new global performance review process on Workday. In our 2019 employee survey, our people told us that they would like to see more career development and progression opportunities, and this new process helps us to deliver this. The changes were also designed to bring more transparency and consistency in helping our people review their performance, and to encourage better conversations with managers. By bringing all performance reviews onto the same platform, we also have higher-quality data to use.

We have a strong record of promoting from within, which helps to embed our culture as well as motivating and retaining our people. Our Early Careers programme is integral to this, and globally this year we welcomed 22 apprentices, 18 graduates and 19 industrial placements into the business, with 158 apprentices and 65 graduates in programmes across the Group. Our intake this year was lower than last year due to COVID-19 restricting what we felt we could provide to our trainees, however we are looking forward to welcoming around 180 trainees in autumn 2022.

The pandemic also meant that we moved our senior leadership development programme online and temporarily paused our plans to expand this programme. Restarting this and other face-to-face learning, and providing more structured development for our middle managers, is a priority for the coming year.

Gender pay gap

23.7%
mean

23.2%
median

2020 UK average (median) pay gap 15.5%

Gender bonus gap

39.1%
mean

26.8%
median

83.9% of women received bonus pay
84.3% of men received bonus pay

Nurturing an inclusive culture

We recognise that nurturing a diverse and inclusive culture is the right thing to do for the success of the business. Having a workforce that represents our customers, our suppliers, and the communities we work with helps us to better understand these stakeholders. A diverse and inclusive culture also helps us to realise the potential of our people, and strengthens our business by ensuring that the full range of views and experiences are shared.

Our Diversity & Inclusion group, established last year, has met throughout this year. Their initial focus has been on raising awareness of diversity and inclusion throughout the Group, including sharing resources on key topics. We also held an Inclusion Week in September 2020, with a series of videos produced by our people on what inclusion means, culture awareness, discussing gender, and supporting individuals. While this group is currently focused on UK activities, we are working with the regional HR teams to align all activities and aim to create a global Diversity & Inclusion strategy.

While we have continued to take action to improve diversity this year, we have more work to do. Although our Board's gender diversity is consistent with that of our business as a whole, our senior management team is much less diverse, and we have a mean gender pay gap in the UK of 23.7%. Our work in encouraging more women into engineering (see page 52) is part of how we will address this, and the activities we mentioned earlier to support middle management into senior management is also intended to help address this imbalance. We are also creating a Gender Pay group to look into this area in more detail and take corrective action, and are also gathering more data on ethnic diversity, where able to do so, to help inform our work on this area too.

Engaging with our people

With the pandemic, the FSP, last year's restructuring, and this year's updated purpose, vision and strategy, we have needed to do more in terms of engagement with our people this year, and have made good progress. We regularly shared updates on our response to the pandemic, and shared 'Business Update' videos on our internal channel, 'Channel R'. Will Lee also presented the updated purpose, vision, and strategy in a series of 'Teams' calls with employees, each of which included time for anyone to ask questions directly to him.

Following the announcement of the FSP in March, Will Lee also held 'Teams' calls to explain what was happening and to hear questions and feedback directly. These calls formed the basis of written Q&As on the FSP, which were shared with our people and regularly updated. We also recorded and shared videos where Will Lee responded to the main questions raised by our people. Our Works Forums have also been important in engaging with our people, regularly meeting in the UK to share employee feedback with senior management.

Catherine Glickman, Non-executive Director, is our ambassador for workforce engagement and has continued to work with our HR teams during the year. With restrictions in the UK easing, we are intending to restart Catherine's onsite visits and direct engagement with our people next year. We will continue to promote the use of the Workday app too, which has been adopted by almost 100% of our manufacturing teams.

Supporting wellbeing

Our main focus for wellbeing this year has been supporting our people throughout the pandemic. We created a wellbeing SharePoint site to share resources, and created a video with one of our mental health first aiders (MHFAs) to raise awareness of what support this team can provide and of the importance of talking about mental health. Our MHFAs provide both onsite and remote support, and our HR business partners also work closely with management and employees to address wellbeing issues.

Our Employee Assistance Programme remains available to all our people and their families, and is a free service that provides confidential support, as well as articles, videos, and podcasts to support wellbeing.

With COVID-19 requiring a large number of our people to work remotely, we have accelerated our review of different working practices. While there is a benefit to be gained for many teams by having people working in the same location, we recognise that having people work from home can help their wellbeing, their local communities, and the environment. During the year we therefore agreed our new hybrid working policy for the UK, which comes into effect in September 2021.

All employee gender diversity ratio

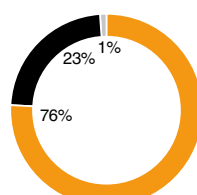

■ 76% (3,528) Male
 ■ 23% (1,095) Female
 ■ 1% (41) Not disclosed

Senior management team diversity

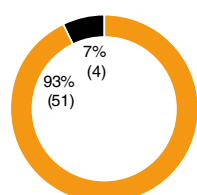

■ 93% (51) Male
 ■ 7% (4) Female

Board diversity

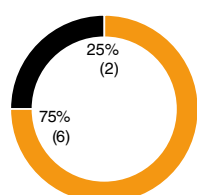

■ 75% (6) Male
 ■ 25% (2) Female

Management level diversity

Management level	M	M %	F	F %
Board	6	75	2	25
Executive Committee	7	88	1	12
Senior managers ¹	11	85	2	15
Subsidiary directors ²	39	95	2	5

¹ Includes the direct reports of the Executive Committee, excluding those in administrative or non-managerial roles.

² Means statutory directors.

Providing a safe working environment

This year saw the H&S team work tirelessly during the COVID-19 pandemic to ensure the key activities were able to continue, as well as protecting the health and safety of our employees and wider communities. This has been achieved through the implementation of safe working measures and on-site lateral flow testing for site-based employees during the second wave of the pandemic.

Despite the challenges of the pandemic, the team has continued to maintain compliance and implement consistent strategies for managing H&S risks across the Group. An example of this is the launch of the online IOSH Managing Safety training programme for line managers within the UK, which is delivered in-house on our learning management system in conjunction with the British Safety Council.

The team worked with Group HR to produce and implement robust homeworking guidance, including an updated homeworking display screen assessment to assess the health and safety risks of homeworkers.

The total number of accidents for the period was 124 (2020: 143) against a year-end headcount of 4,664 (2020: 4,463). This equates to an Accident Frequency Rate of 17.4 per million hours worked (2020: 19.2).

There were three reportable accidents under the UK RIDDOR reporting requirements: two musculoskeletal injuries and one fractured foot from a falling artefact. This equates to a lost time injury rate of 0.42 per million hours worked compared with a UK manufacturing average for RIDDOR reportable accidents of 2.3 per million hours worked.

Looking ahead

We are aiming to restart some of the initiatives that were paused this year, such as onsite visits by Catherine Glickman and the rollout of management and leadership training. We are also planning to improve how we gather feedback for performance reviews, as well as expanding our work in succession planning for senior roles. We will continue with our work to improve diversity, and monitor how changes such as hybrid working are supporting our people and the success of the business.

Managing our resources and relationships continued

Customers

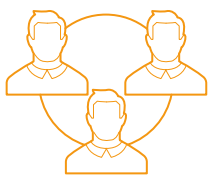

To deliver on our purpose, it is vital that we work closely with our customers to solve their complex challenges and help them to increase their own innovation, improve product quality, expand their production output and enhance their operational efficiencies. Together we can transform our world by addressing societal challenges.

Building relationships

Our key aims for our customer relationships are to:

- build long-term, trusted relationships with our customers to maximise their satisfaction and return on investment. It is not just about a sale, but also about supporting and helping our customers develop their processes and improving the quality of their product output;
- bring high levels of integration to our customers' manufacturing environments. We are especially focused on those businesses who are looking to bring connectivity and the intelligent use of data within their manufacturing processes;
- deliver excellent customer support on a global basis. Our customers can be global, with orders being placed in one country and the product shipped to the eventual end user, who could be located on a different continent. Our ability to support our customers, wherever their machines are installed, builds their confidence and trust in us; and
- provide innovative services to support changing customer expectations and market requirements throughout the life cycle of all our product ranges. We are flexible with our approach and support customer needs from initial purchase, right through to obsolescence.

Renishaw was 'born global' and we have always understood the importance of providing excellent support at a local level. We achieve this through our subsidiary network and long-term distributors. This allows us to assure our customers that whatever their needs, we can support and assist them, resulting in a positive return on their investment.

Although machinery and the application of our products may be common around the world, business practices, local customs, levels of technical expertise and language, are very different, so employing local people is vital. The cost of operating local offices is higher than only using third-party distributors but ensures that Renishaw people are easily accessible to provide fast engineering support and answer queries, which has been critical during the pandemic. Our model is to use the strength of our UK operations for product development, but to decentralise decision-making to our subsidiary network. This allows our local offices to make fast decisions and also to tailor sales and marketing messages and customer solutions to their specific needs.

Establishing feedback

Our future success depends on us:

- understanding customers' true needs and using this to inform future technology innovations;
- gathering customer feedback on new developments during testing programmes; and
- working with customers to help us develop our world-class customer support programmes.

Due to the highly technical nature of our customers' requirements and our products, we prefer to do this through direct contact. The voices of our customers are represented at numerous forums including regional sales and marketing conferences, product line conferences attended by representatives from the sales regions, and service conferences. Members of our Board, Executive Committee and regional presidents also regularly engage with machine builders and end users across our key sales regions. They receive feedback on our performance as a supplier and on how we can continue to help them improve their own products and operational performance.

In June 2021, Renishaw KK, our subsidiary in Japan, received a Supplier Award from the machine tool builder, Yamazaki Mazak, for Outstanding Delivery Performance during the first half of this financial year.

The pandemic has required us to adapt our customer communication channels and make more use of digital marketing technologies to engage with our customers.

A key focus during the year was the hosting of webinars across most of our key markets, allowing us to deliver tailored content about our products and have live engagement with attendees. We organised around 85 webinars with topics ranging from Raman spectroscopy for green energy research to process variation in manufacturing. We also took part in joint webinars with industry partners. Social media, especially LinkedIn, is an increasingly important channel for engagement. Our Smart Manufacturing Ambassadors programme, which gives social media training and support to customer facing employees, has increased our online engagement and support for customers.

During the year we attended just eight physical exhibitions, although we did take part in a further 15 virtual replacement exhibitions, including IMTS Spark in the USA. These generated multiple enquiries from customers and prospects, which were recorded and stored digitally in accordance with our privacy notice (which is set out on our website), to ensure appropriate follow-up by our sales teams. We do however look forward to the general resumption of trade exhibitions, which allow for a depth of interaction that is simply not possible using digital platforms.

To compensate for the loss of the many thousands of enquiries generated at trade shows, we have accelerated the implementation of marketing automation to coordinate our email, web and social media messaging, and to deliver more tailored customer experiences.

Suppliers

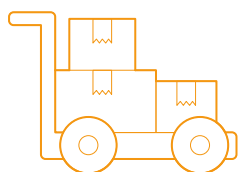

The supply of outsourced goods and services is critical to our overall success. We have developed processes and procedures to ensure all supply chains and supplier relationships are managed in an effective way.

Developing relationships

Our purchasing teams in the UK, Ireland, India, China, the USA, and various European countries work hard to develop strong, effective relationships with our suppliers. By having teams located close to many of our suppliers we can have regular and direct communications while addressing differences in culture, time zone and language.

In the UK many of our suppliers are within a 100-mile radius of our main manufacturing sites, and we take pride in working with local SMEs (small and medium-sized enterprises) where possible.

Overcoming challenges in the year

The COVID-19 pandemic and Brexit have both presented challenges in the year in terms of our supply chain, and our strong relationships with suppliers have been important in overcoming these challenges.

Our Brexit planning ensured that we faced no significant disruption, as we had increased our purchasing in advance of the transition window ending on 1 January 2021, to limit the expected delays around this time. A combination of Brexit and reduced air freight as a result of the pandemic meant that we had to work closely with our shipping agents to ensure smooth supply, and these issues eased in the latter part of 2021.

The disruption in supply chains across the world as a result of the pandemic have been well documented and have been an area of focus in the business this year. The responsiveness and quick decision-making of our buyers has helped us to adjust quickly to the changing environment, and having teams based close to main sources of supply has also helped us to identify new suppliers where needed. We are grateful to our suppliers for their support in working with us throughout this challenging period,

Expenditure on goods and services:

£119.5m

Average UK payment days:

47
(2020: 45)

and are pleased that supply disruption has not resulted in needing to halt our manufacturing at any point this year.

Working with high-quality and ethical suppliers

We recognise the need to protect the interests of our employees, customers and shareholders by ensuring that our supply chains are as risk-free as possible. We use a risk management process that regularly assesses supply chain risk and, where possible, looks to introduce secondary sources for all key outsourced requirements. Where this is not possible, bespoke inventory policies are implemented to allow us to manage any potential disruption in the supply chain.

We actively involve suppliers in our supplier performance programme. Existing suppliers are assessed on a regular basis to ensure that they meet expectations in the areas of delivery, quality, corrective actions and responsiveness. Where there are shortcomings, we engage with suppliers to ensure they are trained in good practice and appropriate ongoing improvement programmes are put in place.

Our supply chain and engineering teams put great emphasis on ensuring that suppliers have the ability to meet our high standards of quality by engaging with suppliers as early as possible. Where necessary, we work closely with suppliers to ensure that they have the controls in place to ensure the ongoing supply of quality goods and services. We share known good practices and our knowledge and experience.

We are committed to conducting our business with honesty and integrity; suppliers are no exception to this policy. All suppliers we engage with are required to comply with our trading terms and Group Business Code, covering areas such as modern slavery, conflict minerals, human rights, anti-bribery, tax evasion, data protection and dangerous goods.

Managing our resources and relationships continued

Communities



Our values of integrity and involvement are central to the relationships we have with our communities around the world, where we strive to be open, honest and consistent. We aim to be an inspiring employer, a responsible business, and we recognise the impact we have on our communities. We aim to make a positive difference and maintain an open dialogue with community representatives.

Our approach

We achieve these aims through:

- engagement with trade and general business organisations;
- support for community sustainability initiatives;
- financial support for charities and other not-for-profit organisations;
- engagement with local and national governments and elected representatives;
- our extensive education outreach initiatives and large work experience programmes;
- support for employee fundraising and volunteering;
- the free use of our facilities for educational and other community events; and
- the sponsorship of community sports clubs and festivals for science, music and the arts.

Community engagement

We support a wide range of arts, music and sports organisations in the West of England and South Wales where our main UK sites are located. During the year, this included: the SS Great Britain Trust; Bristol Music Trust; sponsorship of Cardiff Blues and Scarlets Women rugby teams; and sponsorship of professional rugby players including Wales internationals Samson Lee and Tomos Williams.

We are increasingly active with initiatives that aim to create more sustainable communities, including a Greenway project that aims to provide a traffic-free route that connects our New Mills headquarters site with local towns and villages, and we are also a member of Stroud District Action on Plastic.

Due to the pandemic we have been unable to host the types of organisations that we have in previous years, including business clubs, primary and secondary schools, colleges and universities, so we have turned to virtual engagement, especially with schools.

We actively support the business community regionally, nationally and internationally, through active membership of trade associations and industry research centres. Some of these include: Canada Makes; the European Society for Precision Engineering & Nanotechnology; Verein Deutscher Werkzeugmaschinenfabriken e.V. and PräziGen (Germany); UCIMU-SISTEMI PER PRODURRE (Italy); Global 3D Printing Hub (Spain); Association of British Healthcare Industries and Manufacturing Technologies Association (UK); and the Additive Manufacturing Users Group (USA).

Education outreach

Our education outreach programme is designed to excite, interest and engage young people, regardless of gender, sexuality, ethnicity or background, to study STEM subjects and to consider engineering as a career. We aim to be a key educational resource for the hands-on learning of design, fabrication, manufacturing and engineering skills, delivering virtual and physical workshops from our Gloucestershire HQ, where a new education centre will open in Autumn 2021, and the longstanding education centre at our Miskin site in South Wales, UK.

In an average academic year, we engage with around 22,000 students through our various outreach programmes in South Wales, Gloucestershire and Bristol. Due to the pandemic, most activities during the year had to move online, yet we still held 112 events and engaged with more than 5,000 students through the development of new interactive virtual workshops for 3D printing and coding, virtual careers/assembly talks and virtual work experience weeks. With a focus on diversity, we also developed activity packs for local schools to support International Day of the Girl, held Girls4STEM webinars and a female-only work experience week. Activity packs were also sent to nine SEND (special educational needs and disabilities) schools supported by virtual interactive workshops. Our four full-time outreach employees are supported by more than 130 STEM ambassadors.

We also work with education providers in many of our sales regions. In the USA, Renishaw Inc has partnered with Davis Technical College, Utah, to provide its CNC machining students with access to the latest Renishaw measurement technology and support from our engineers.

Charitable giving

Around the world we support charities and not-for-profit organisations within our communities, through formal charities committees, individual employee fundraising and one-off fundraising events. The committees are focused on supporting organisations local to Renishaw offices that help enrich the lives of children and adults, from toddler groups and sports clubs, through to organisations that support people with disabilities and the bereaved. In the UK, an additional fund is administered by the employee-led charities committee, which donates monies to aid the victims of global disasters.

In 2021, we made direct donations totalling nearly £239,000 to over 170 different organisations. The UK's employee-led charities committee donated £10,000 to support countries hit hardest by the pandemic and continued to proactively support foodbanks located close to our major sites. In Germany, we supported emergency call boxes at local lakes; in Brazil, we supported children with new clothing, a toy and a pair of shoes as part of a Christmas campaign by a local church in Barueri; and in India, we supported multiple projects focused on healthcare improvements, female empowerment and education, especially for students from socially disadvantaged families. This included a £38,000 donation to the Janakalyan Rakta Pedhi Blood Bank for equipment that enabled increased supply of plasma and other blood projects in the Pune region during India's second wave of COVID-19.

During the year we also continued to support IT Schools Africa, to whom we donate older computer equipment to enable the charity to give a digital education to students and communities in Africa and Gloucestershire. Since 2012 we have donated 2,745 computers, laptops and monitors.

Shareholders



With around 53% of our shares being held by the founders, Sir David McMurtry and John Deer (our Executive Chairman and Non-executive Deputy Chairman respectively), we have an investor profile that is quite different to most other large listed companies. We recognise the trust that our minority shareholders have placed in us, and aim to provide sustainable long-term growth in return.

Investing for the future

To deliver sustainable long-term growth, we have continued to invest in research and development this year, with £76.6m spent on engineering costs in the year, of which £9.8m was capitalised. As explained on page 15 we have also better prioritised our projects this year, focusing on products that we believe offer the best return on our investment. To support future growth, we have also had planning permission approved to expand our manufacturing site at our Miskin site in Wales. With improved profits and cash, we have reinstated the dividend programme, with an interim dividend paid of 14.0 pence net per share on 6 April 2021 and propose a final dividend of 52.0 pence net per share.

Improving performance and returns

In the previous financial year, we made some difficult decisions to preserve cash and protect the long-term success of the business. This included cancelling the interim dividend, deciding not to propose a final dividend, and undertaking a rightsizing programme which led to a number of redundancies in the Group. While these decisions were difficult, we believe they were appropriate and that our results this year support that.

Our financial performance has improved significantly despite disruption from COVID-19 throughout the year, with Adjusted profit before tax increasing from £48.6m last year to £119.7m this year, and statutory profit before tax increasing from £3.2m last year to £139.4m this year. Our cash and bank deposit balances have increased from £120.4m at 30 June 2020 to £215.0m at 30 June 2021.

Shareholdings

Directors

52.84%

Individuals

1.09%

Institutions

46.07%

FSP

In March 2021 the commencement of the FSP was announced, which we recognise as a significant event for our shareholders.

The Board carefully reviewed a number of proposals with its advisers and unanimously concluded that none would meet the Board's objectives of delivering an outcome that satisfactorily met the interests of all stakeholders. On 7 July 2021, the Board announced that it had unanimously decided to conclude the FSP.

Sir David McMurtry and John Deer have indicated to the Board they remain committed to Renishaw. More information on the Board's consideration of our other shareholders can be found on pages 56 to 57.

Engaging with shareholders

Our 2020 AGM was held behind closed doors because of the ongoing pandemic. We invited shareholders to submit questions in advance to a dedicated email inbox.

During the year we also held open webcasts for the 2020 full-year results and 2021 interim results, with Q&A sessions held at the end of both. Recordings of these are made available on our website.

We would normally hold our Investor Day in the spring, however the pandemic has meant that we have not been able to do this in 2020 nor 2021. We look forward to reinstating this event when we can safely host investors at our head office in Gloucestershire, which we hope will be in 2022.

Managing our resources and relationships continued

Planet



We are committed to playing our part in looking after the environment and protecting it from significant issues such as climate change. We do this not only by improving the footprint of our own operations, such as reducing the emissions from our manufacturing facilities, but also by providing solutions to customers to help them manufacture more with less and to deal with the shift to a more sustainable world.

Helping customers to manage scarce resources

In a world of increasingly scarce resources, helping customers to manage these resources is at the heart of what we do. With our manufacturing technologies, we help customers to manufacture as accurately and efficiently as possible, reducing wastage. Our technologies are well placed to assist our customers who are changing their business model in response to the opportunities and risks of climate change, such as those moving from traditional ICE vehicles to plug-in hybrid electric vehicles (PHEV) and EV.

We have operated our RBE (repair by exchange) programme since 1992, where customers returning a faulty unit are offered a refurbished unit as a replacement, at a discounted rate. Actions such as this help to reduce waste across the supply chain and support product circularity. We have established a cross-functional working group to look for more opportunities to increase the circularity of our products.

Lowering our emissions

We are pleased to have reduced our statutory GHG emissions by 343 tCO₂e this year. This is mainly due to using our Group-owned vehicles less as a result of the pandemic. Our total measured GHG emissions have increased however, mainly as a result of the switch to home working for many of our people and due to higher emissions from distribution as revenue has increased. While the inclusion of emissions from home working has increased the overall measured emissions this year, we are pleased that the significant reduction in air travel in our business has caused a reduction of 1,316 tCO₂e from this form of travel. While we

Total statutory emissions
tCO₂e

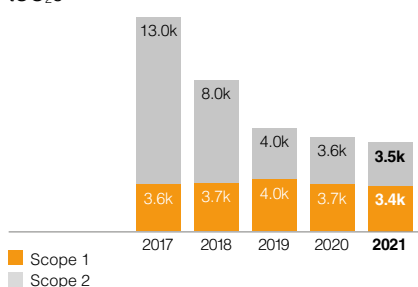

Statutory GHG emissions
tCO₂e per £m turnover

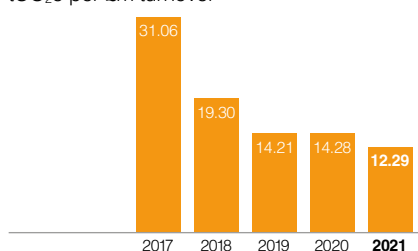

Group energy consumption
kWh

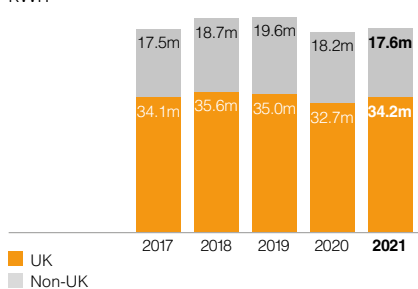

Energy source
kWh

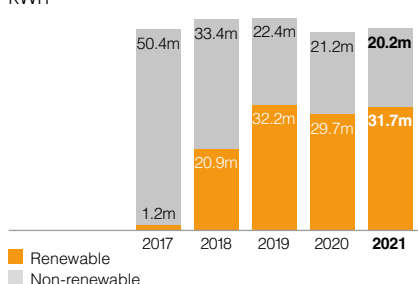

Total measured GHG emissions
tCO₂e

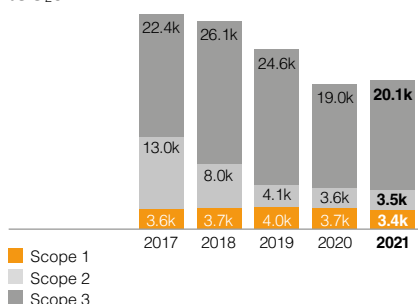

Each GHG measure listed above is calculated using the market-based approach.

expect some air travel to return in the business as travel restrictions relax, our new ways of working and making better use of technology should mean that we do not return to our pre-pandemic levels of air travel.

In December 2020 we introduced our new Group policy on electricity purchasing, requiring all our Group companies to only use electricity from certified renewable sources. This means that when existing contracts expire, we will move to renewable electricity. We are looking at ways to further speed up this move to 100% certified renewable electricity.

Minimising our waste

With a significant increase in trade from last year, our waste totals have increased from 2,236 tonnes to 3,671 tonnes. 94% of this increase however is waste that we have reused, recycled, or composted. Waste handling and processing restrictions have still been in place because of the pandemic, meaning that we have sent 9% of our waste to landfill this year, above our 5% target. While this is disappointing, prioritising the health and safety of our people and our contractors has been the right thing to do. We are confident that we can reduce this proportion as restrictions lift.

We have also been focused on ensuring our product and transit packaging has the lowest impact possible. By replacing the carton tape with a paper tape we have removed 475km of plastic tape from the supply chain.

We recognise a significant proportion of our waste is created from our manufacturing processes and have a dedicated manufacturing waste champions team to focus on improvements.

Looking ahead

Our main focus for next year is to finalise our Net Zero strategy, which we have been developing this year, including ensuring that our people understand what we are doing and how they can support this. We will also look to expand our use of solar panels, and our factory in Dublin, Ireland, will provide a significant opportunity to improve our renewable energy consumption. We are optimistic that the easing of COVID-19 related restrictions will see improvements in reducing the proportion of waste we send to landfill.

More details on our emissions and waste management data can be found on page 157.

Task Force on Climate-related Financial Disclosures

Next year's Annual Report, for the year ended 30 June 2022, is the first in which the recommendations of the Task Force on Climate-related Financial Disclosures (TCFD) are mandatory for the Group. Ahead of this mandatory reporting, we have set out below our 2021 position and our priorities for reporting in 2022.

2021 position	2022 priorities
Governance	
<p>Allen Roberts, our Group Finance Director, is responsible for Corporate Responsibility (CR), including climate-related matters.</p> <p>Our risk committee meets throughout the year, and discusses financial and non-financial risks, with climate-related risks being incorporated into some of our principal risks.</p> <p>We also have a CR committee, with their climate-related work mainly being based around how to increase energy efficiency and reduce emissions from our operations.</p>	<p>▶ Develop our Board reporting of climate-related matters.</p>
Strategy	
<p>Climate change presents both risks and opportunities to the business. For example, the move to electric vehicles presents risks from the potential loss of business as automotive customers reduce their investment in production lines for ICEs, but also significant opportunities as they switch their investments to manufacturing facilities for EVs.</p>	<p>▶ Identify how our proposed Net Zero strategy will affect our business model, particularly in areas such as purchasing, and our sales and distribution channels.</p>
Risk management	
<p>Climate-related risks are identified from our risk identification and management process, outlined on page 32.</p> <p>Our principal risks of industry fluctuations, economic and political uncertainty, and loss of manufacturing output, include climate-related risks.</p>	<p>▶ Develop our risk reporting for climate-related matters.</p> <p>▶ Assess risk appetite for climate-related matters.</p>
Metrics and targets	
<p>We monitor our GHG emissions, energy consumption and waste totals, which can be found on page 54.</p>	<p>▶ Establish our Net Zero strategy, and report our progress against it.</p>

Non-financial reporting statement

We need to include in our Annual Report certain non-financial information, as required under sections 414CA and 414CB of the Companies Act 2006. The table below shows where this information can be found in this Report, and it can also be found on our website www.renishaw.com

Our business model is set out on pages 4 to 5, and our non-financial KPIs are disclosed on page 19.

	Policies and statements	Related principal risks
Environmental matters Pages 54–55	Group Business Code Group Environmental Policy	Industry fluctuations (page 34) Loss of manufacturing output (page 40)
Employees Pages 17, 48–49	Group Business Code	People (page 34)
Social matters Page 52	Group Business Code	Industrial fluctuations (page 34)
Respect for human rights Pages 48, 49, 51	Group Business Code Slavery and Human Trafficking Statement	People (page 34) Supply chain dependencies (page 34)
Anti-bribery and anti-corruption Pages 42–43	Group Business Code Group Anti-Bribery Policy	Non-compliance with laws and regulations (page 42)

GHG emissions calculation

To calculate our GHG emissions we have used the GHG Protocol Corporate Accounting and Reporting Standard (revised edition) and the UK Government's GHG reporting guidance. The emission factors are taken from the DEFRA, IEA and IPCC libraries and energy suppliers. Our GHG emissions are based on data taken from bills, invoices, meter readings and expense claims or modelled using recognised methodologies. For our Scope 1 and 2 emissions, less than 2% of the data is estimated.

Section 172 statement

Key requirement

Under the Companies Act 2006, the Directors are required to explain how they have complied with their duty to have regard to the matters in section 172 (1) (a)-(f) (Section 172) of the Companies Act 2006. Under Section 172 a director of a company must act in the way they consider, in good faith, would most likely promote the success of the company for the benefit of its shareholders. In doing so the director must have regard to other matters including:

- likely consequences of any decisions in the long term;
- interests of the company's employees;
- the need to foster the company's business relationships with suppliers, customers and others;
- impact of the company's operations on the community and the environment;
- the company's reputation for high standards of business conduct; and
- the need to act fairly as between members of the company.

Principal decision	Stakeholders
<p>As announced in March this year, Sir David McMurtry and John Deer, indicated to the Board their intention to sell their very substantial shareholdings in Renishaw.</p> <p>The Board considered various options with its advisers. In considering these options the Board had regard to the interests of all the Company's stakeholders. The Board unanimously concluded that it would be appropriate to investigate the sale of the Company and therefore launched an FSP.</p>	<p>Shareholders, employees, customers, suppliers, communities, regulators, Renishaw pension funds</p>
<p>In light of the improved financial performance of the Group, due to the quicker than expected recovery from the COVID-19 pandemic (primarily in APAC) and positive impact of our cost control measures implemented last year, the Board debated whether to reinstate dividends.</p>	<p>Shareholders, employees, customers, suppliers</p>
<p>The development, implementation and communication of our new purpose, vision and strategy across the Group, while ensuring these aligned with our culture and values, was a key area of focus during the year.</p>	<p>Employees, customers, suppliers, communities</p>
<p>With the continued challenges presented by the ongoing COVID-19 pandemic, the Board considered how best it can mitigate the negative impacts on the health, safety and wellbeing of our people, customers and communities that we operate in.</p>	<p>Employees, communities, customers, suppliers</p>

Examples of the way in which the Board had regard to Section 172 matters

How the Board engaged with employees, suppliers and customers during the year is explained in the stakeholder engagement model on pages 46–47. Regular reports on health and safety, environment and security are provided to the Directors supporting them when considering the impact of their decisions on our community and the environment. Further information can be found on pages 32, 42, 49 and 54. Ensuring high standards of business conduct is critical for our success. The Directors also receive reports from the Group Legal, Quality, Compliance, Human Resources and Corporate Responsibility teams, and our Non-financial reporting statement on page 55 identifies policies and guidelines governing our approach to anti-corruption, anti-bribery, social matters and human rights. Consideration of the long-term impact of decisions is integral to the approval of strategy, and our strategic progress this year is disclosed on pages 12–17.

Examples of how the Directors discharged their Section 172 duty when taking the principal decisions during the year

The Board takes the interests of stakeholders into account when making decisions. The relevance of each stakeholder group may increase or decrease depending on the issue in question, so the Board seeks to understand the needs and priorities of each group during its discussions. This, together with considering the long-term consequences of decisions and maintaining our reputation for high standards of business conduct, has always been integral to the way our Board operates. During another challenging year, the below have been the principal decisions taken and how stakeholders views have been considered:

Engagement/Consideration	Outcome	Page(s)
<p>Will Lee held 'Teams' calls with senior managers to explain what was happening and to hear questions and feedback directly. These calls formed the basis of written Q&As on the FSP, which were shared with our people and regularly updated.</p> <p>We also recorded and shared videos where Will Lee responded to the main questions raised by our people. Our Works Forums have also been important in engaging with our people, regularly meeting in the UK to share employee feedback with senior management.</p>	<p>In July 2021, the Board announced that it had unanimously decided to conclude the FSP. The Board carefully reviewed a number of proposals with its advisers and unanimously concluded that none met the Board's objectives of delivering an outcome that satisfactorily met the interests of all stakeholders.</p> <p>Sir David McMurtry and John Deer have indicated to the Board they remain committed to Renishaw.</p>	59
<p>Before reinstating dividends, it was important for the Board that our people had been brought back to their full pay and working hours, and that the Company had repaid the furlough scheme monies received for the year.</p> <p>All considerations took place with our long-term financial position and the pandemic in mind. The Board considered the impact of reinstating dividends on the Group's balance sheet, being able to deliver on our strategy and wider capital allocation plans including our R&D activities, and ensuring there would be no impact on our other financial commitments or service and offerings to customers.</p>	<p>After considering the various factors, the Board concluded that reinstating the dividend policy was in the best interests of the Company, its shareholders and other stakeholders, while still allowing us to continue investing in R&D which is central to our success and purpose.</p> <p>An interim dividend of 14.0p per share was declared in the Group's half-year results announcement and paid to shareholders on 6 April. A final dividend of 52.0p has also been proposed by the Directors, which will be voted on by the shareholders at the 2021 AGM.</p>	94
<p>The interests of all our key stakeholders, likely long-term consequences, the long-term sustainability of Renishaw and our role in society were all considered when setting the purpose and vision and evaluating the strategy options. This included reviewing how we create value for our various stakeholders and the changing needs of our customers.</p> <p>Employees were involved in articulating the Group's purpose and developing our new strategy. A bottom-up approach involving senior management helped ensure all parts of the business were considered. Teams in the business were also encouraged to develop their own strategies that aligned with and supported the purpose and vision.</p>	<p>Involving employees during the implementation phase helped ensure the purpose, vision and strategy genuinely reflected our business and considered the interests of our people. Our delegation of authority was refreshed to support the new strategy and vision.</p> <p>The new purpose, vision and strategy was communicated across the Group personally by our Chief Executive, Will Lee, via numerous virtual 'town hall' meetings, where employees could provide feedback and ask questions. A video was also posted on Channel R, our internal communications channel available on the employee intranet.</p>	7, 8, 10 and 12–17
<p>It was of utmost importance to the Board that the safety and wellbeing of our employees was put first during the pandemic. A working from home survey was sent out to all UK-based employees to determine working conditions while working from home, how they could be improved and their future preferences. The Board received the outcome of this survey along with frequent reports from the COVID-19 steering committee about the measures being implemented across the Group to protect our onsite workforce, and the great work our employees were doing to keep the business running.</p>	<p>The COVID-19 steering committee, formed last year, continued to undertake risk assessments and oversee the implementation of strict health and safety measures across all our sites. It also ensured best practice was shared and support provided across all our overseas locations so people could return to work safely when allowed. A new hybrid working policy was adopted as a result of the working from home survey. Our employees were also reminded of various resources available to help with their physical and mental wellbeing. A thank you payment was made to all employees in recognition of their dedication throughout the pandemic.</p>	9, 32, 44, 49

Allen Roberts

Group Finance Director

The Strategic Report on pages 1–57 was approved by the Board on 21 October 2021 and signed on its behalf by:

Sir David McMurtry

Executive Chairman

Directors' Corporate Governance Report



A strong governance framework, overseen by the Board, is critical if we are to support the business and enhance the interests of all our stakeholders.”

Sir David Grant

Senior Independent Director

Introduction

I am pleased to introduce our Directors' Corporate Governance Report for the year, in which we describe our governance arrangements, the operation of the Board and its Committees, and how the Board discharged its responsibilities. The Board is ultimately responsible to our stakeholders for all our activities, our strategy and financial performance, the efficient use of resources and social, environmental and ethical matters.

Central to everything we do is our purpose of Transforming Tomorrow Together. We are proud of our culture that aims to allow our employees to maximise their potential, and aligns with our purpose, strategy and values – see page 1 for more information.

Having a strong governance framework, which supports our long-term strategic development, is critical for us to deliver on our purpose, support the business and benefit all our stakeholders.

As announced in March this year, Sir David McMurtry and John Deer indicated to the Board their intention to sell their very substantial shareholdings in Renishaw.



The Board considered various options with its advisers. In considering these options the Board had regard to the interests of all the Company's stakeholders. The Board unanimously concluded that it would be appropriate to investigate the sale of the Company and therefore launched an FSP for the Company.

The Board carefully reviewed a number of proposals with its advisers and unanimously concluded that none met the Board's objectives of delivering an outcome that satisfactorily met the interests of all stakeholders. In July 2021, the Board announced that it had unanimously decided to conclude the FSP.

Sir David McMurtry and John Deer have indicated to the Board they remain committed to Renishaw.

The Board made a number of significant decisions in response to the COVID-19 pandemic, and the associated global macroeconomic uncertainty, to ensure our long-term success. These included the establishment of the COVID-19 steering committee, the adoption of a new hybrid working policy in the UK, and the implementation of strict health and safety measures across our sites.

Illustration:

The original mill building at our New Mills headquarters in Gloucestershire, UK.

The interim and final dividends were reinstated as trading conditions improved and support received from the UK furlough scheme since 1 July 2021 was repaid – see page 94 for more information.

The Board continually monitors our governance arrangements. We regularly discuss the most effective methods of achieving greater Board engagement with our people and other stakeholders, and focus on building on our existing initiatives, in order to better understand their views. Non-executive Director and designated workforce engagement officer, Catherine Glickman, provides the Board with greater visibility of workforce engagement activities and brings our people's views into the Boardroom through her attendance at meetings with employee groups. Catherine has also continued to work with our HR teams during the year and, with restrictions in the UK easing, we are intending to restart Catherine's onsite visits and direct engagement with our people next year. It is essential that this framework is dynamic and we are able to respond as our business and our stakeholders evolve. Further information on workforce engagement can be found on pages 48–49.

We are committed to equality and diversity at all levels, and this remains an important area of focus for the Board. Employment policies are designed to give equal opportunities irrespective of race, religion, gender, age, socio-economic background, disability or sexual orientation – see page 48 for more information.

The Board has engaged with the themes of diversity and inclusion throughout the year, for example:

- at the October 2020 Board meeting we reviewed material sent to colleagues across the Group to celebrate Inclusion Week, which ran from 28 September through to 4 October 2020 and covered a range of themes, including gender and culture; and
- at the February 2021 Board meeting the Board reviewed the UK's Diversity & Inclusion (D&I) strategy.

This strategy included:

- 'continuing the conversation' with employees on a range of D&I topics throughout the year;
- gathering data through Workday on a voluntary basis and in a sensitive and legally compliant manner to help inform the strategy in the years ahead; and
- partnering with recognised external national networks on D&I matters such as WISE.

The Board takes seriously its responsibilities for ensuring all our people act with openness, honesty and transparency. As we continue to grow, it is vital that we maintain a strong culture which aligns with our purpose, strategy and values. Our culture and ethics are embedded in our Group Business Code and Anti-Bribery Policy which can be found at: www.renishaw.com/businesscode.

We continue to work on robustly assessing and mitigating our principal risks via our risk committee and reporting on those activities – see pages 30–43 for more information.



Directors' Corporate Governance Report continued

Board of Directors



Sir David McMurtry N*
CBE, RDI, FREng, FRS, CEng, FIMechE
Executive Chairman

Appointed September 1975

Areas of expertise

Strategy, Product Development, Engineering, Science/Technology

Contribution, skills and experience

- Co-founder of Renishaw, provides strong leadership to the Board, and responsible for Group innovation, product strategy, and Group technology.
- Significant contribution to the long-term sustainable success of the Company and all aspects of the business.
- Strategic vision, and technical and industry knowledge.

External appointments

- None



John Deer
Non-executive Deputy Chairman

Appointed July 1974

Areas of expertise

Manufacturing, Strategy, International

Contribution, skills and experience

- Co-founder of Renishaw and contributes to Board leadership and strategic decisions for growing the business.
- Extensive manufacturing and quality experience contributes to the delivery of efficient, high-quality manufacturing.
- Strategic vision, and commercial and international experience.

External appointments

- None



Will Lee
MA, MBA, FinstP
Chief Executive

Appointed August 2016 as Group Sales and Marketing Director, February 2018 as Chief Executive

Areas of expertise

Sales and Marketing, Strategy, Engineering, Operations

Contribution, skills and experience

- Effective and strong leadership and management, both technical and commercial, with an acute awareness of the industry and its opportunities and challenges.
- Maintains a wide breadth of knowledge, as well as strong stakeholder relationships which continue to develop the Renishaw business.
- Joined the Renishaw graduate scheme in 1996 and since then has held various senior management positions in engineering, operations, and sales and marketing resulting in an in-depth understanding of the Group's business, products and markets.

External appointments

- None



Allen Roberts
FCA
Group Finance Director

Appointed October 1980

Areas of expertise

Finance, Strategy, Internal Controls, Operations, Compliance

Contribution, skills and experience

- Invaluable contribution to financial planning and strategy, including adept management of financial risks and business development.
- Deep understanding of the Group's businesses, products, relationships and the sectors in which it operates.
- Experienced in the management of financial risks, reporting and planning

External appointments

- None



Sir David Grant A N R
CBE, PhD, FREng, FLSW, CEng, FIET
Senior Independent Director

Appointed April 2012

Areas of expertise

Engineering, People, Science/Technology

Contribution, skills and experience

- Contributes to talent recruitment, increasing diversity and development of workforce.
- Extensive engineering experience and recognised for his contributions to industry.
- Various previous leadership positions at international engineering companies and government-related science and technology bodies.

External appointments

- None

Carol Chesney A N R

FCA

Independent Non-executive Director

Appointed October 2012**Areas of expertise**

Finance, Corporate Governance, Internal Controls, Compliance, M&A, Pensions

Contribution, skills and experience

- Contributes to the effectiveness of the Board.
- In-depth understanding of corporate governance, internal controls, compliance, M&A, tax and pensions.
- Career experience in finance, as a company secretary, audit committee chair and having responsibility for health and safety compliance in listed company environments, and a wide industry perspective.

External appointments

- Non-executive director and audit committee chair of Hunting plc
- Non-executive director and audit committee chair of Biffa plc
- Non-executive director and audit committee chair of IQE plc

Catherine Glickman A N R*

BA

Independent Non-executive Director

Appointed August 2018**Areas of expertise**

People, Remuneration, Pensions, Strategy

Contribution, skills and experience

- Renishaw HR team is able to leverage Catherine's background.
- Skilled at developing reward structures that align leadership motivation with group strategy.
- Extensive HR, remuneration and pensions experience, as well as previous international experience with Genus plc and Tesco PLC.

External appointments

- Non-executive director and remuneration committee chair of TheWorks.co.uk plc
- Non-executive director and remuneration committee chair of RPS Group plc

John Jeans A N R

CBE, CEng

Independent Non-executive Director

Appointed April 2013**Areas of expertise**

Healthcare, International, Strategy

Contribution, skills and experience

- Healthcare sector knowledge gained from senior leadership positions in various global companies.
- Experience serving on several government bodies relating to healthcare.
- Invaluable insight into the healthcare industry from a government/regulatory perspective.

External appointments

- Non-executive director of Edinburgh Molecular Imaging
- Chair of the Scottish government's Digital Health & Care Innovation Centre at the University of Strathclyde
- Chair of the strategic advisory panel for the Singapore Government's diagnostics hub
- Adviser to the Singapore Government on advanced manufacturing, health and biomedical science
- Leads Innovate UK's knowledge transfer network's (KTN) health board

Jacqueline Conway

General Counsel & Company Secretary

Appointed November 2019**Areas of expertise**

Corporate Governance, Risk and Compliance

Contribution, skills and experience

- Responsible for providing legal and governance advice to the Board and senior management, as well as leading the legal function.
- Specialised in corporate governance, risk and compliance.
- Substantial experience of operating in a listed environment.

External appointments

- None

Committees

- A Audit Committee
- R Remuneration Committee
- N Nomination Committee
- * Chair of Committee

► Read more extensive Board biographies online.

 Visit www.renishaw.com/en/board-of-directors-and-company-secretary--21878.

Directors' Corporate Governance Report continued

Executive Committee

Will Lee* (chair)

Chief Executive

See page 60 for biography

Sir David McMurtry*

Executive Chairman

See page 60 for biography

Allen Roberts*

Group Finance Director

See page 60 for biography

Jacqueline Conway

General Counsel &

Company Secretary

See page 61 for biography

* These members of the Executive Committee were also plc Board Directors during 2021. Further information on the Executive Committee can be found on page 65.



Geoff McFarland
Director of Group Technology

Appointed July 2001

Retired September 2021

Contribution, skills and experience

- Executive Committee responsibility for Renishaw's research centres and intellectual property.
- Skilled in computer-aided mechanical engineering.
- Experience in the medical device and electronic manufacturing sectors.



Leo Somerville
President, Americas

Appointed March 2004

Contribution, skills and experience

- Executive Committee responsibility for development of the Americas region.
- Strong leadership and business development skills combined with in-depth market and product knowledge.
- Experience as project manager for machine tool probing in the UK, and as business manager for machine tool probing and calibration products at Renishaw Inc.



Dave Wallace
Director of Group Operations

Appointed January 2008

Contribution, skills and experience

- Executive Committee responsibility for the management and strategy of Group Operations.
- Deep insight into Renishaw's products, markets, and product development, as well as strong management skills.
- Has worked in various functions of the business, including as Director and General Manager for the CMM Products Division and previously held Executive Board responsibility for the Industrial Metrology business.



Gareth Hankins
Head of Group Manufacturing

Appointed February 2018

Contribution, skills and experience

- Executive Committee responsibility for manufacturing operations, procurement and facilities management across the Group.
- Skilled leader with acute insight into operations and manufacturing.
- Experience in engineering, production, and operations and business management, including previous role as operations manager for styli and custom products.



Mark Moloney
Director and General Manager, Renishaw (Ireland) DAC

Appointed February 2018

Retired March 2021

Contribution, skills and experience

- Was responsible for manufacturing capabilities and resources in Ireland and Lyon, France, and for the establishment and expansion of our facilities in Pune, India.
- Skilled leader in operations and manufacturing.
- Prior experience in a production and inventory planning management role, including development of bespoke MRP/ERP systems for manufacturing.

Scope of disclosures

In our Corporate Governance Report, we have incorporated:

- the Audit Committee Report (page 71);
- the Nomination Committee Report (page 68); and
- the Directors' Remuneration Report (page 77).

We have prepared this report in accordance with the Governance Code and have also described how we have applied its principles. The Governance Code can be viewed at: www.frc.org.uk.

We report on the operation of our business in the following ways:

– Our business and likely future developments

The Executive Chairman (on pages 6–7) and the Chief Executive (on pages 8–11) have given a review of our business and likely future developments. We have also reported on these aspects in our Strategic Report. We also report our results by operating segment in note 2 to the Financial statements, together with an analysis of revenue by geographical market.

– Management Report

We include a management report in our Strategic Report, as required by the Financial Conduct Authority's Disclosure Guidance and Transparency Rules (DTR).

– Directors' Report

The Directors' Corporate Governance Report and Other statutory and regulatory disclosures set out on pages 58–96 together form the Directors' Report.

– Corporate Governance Report

We set out our corporate governance practices in the Directors' Corporate Governance Report (on pages 58–97), which forms part of the Directors' Report, as required by the DTR.

– Shareholder information

We set out certain information, which is required by the Financial Conduct Authority's Listing Rules (LR) to be provided to our shareholders, in the Directors' Corporate Governance Report (pages 58–97), the Directors' Remuneration Report (pages 77–93) and the Other statutory and regulatory disclosures (pages 94–96). This includes information relating to arrangements with controlling shareholders.

Reporting against the Governance Code

To avoid duplication in this report, the table below cross-refers to explanations given elsewhere of how we have sought to comply with the key principles and provisions of the Governance Code. We report against other relevant Governance Code principles and provisions within this Directors' Corporate Governance Report.

Topic	Page(s)
Company purpose	1
Values and culture	7
Workforce engagement	48–49
Other stakeholder engagement	46–47, 50–54
Strategy and business model	4–5, 12–17
Effective controls	67
Sustainability	54–55
Capital allocation	22–23, 38–39
Workforce policies and practices	48–49, 55, 95
Risk management	30–43

1. Board leadership and Company purpose

Engagement with shareholders and other stakeholders

The global economic climate has required us to continue to monitor the business extremely carefully this financial year, in order to safeguard its longer-term future. The Board aims to achieve effective engagement with our shareholders and other stakeholders, especially with respect to key Board decisions. The table on pages 56–57 illustrates examples of engagement and how the Board has considered Section 172 obligations in Board discussions and decision-making. The Board continues to monitor progress with engagement mechanisms.

The AGM takes place at our headquarters or one of our other sites and notification is sent to shareholders in advance of the meeting. The Chief Executive and other nominated presenters each give a presentation on the business, and all Directors, including the Chairs of the Audit, Remuneration and Nomination Committees are available for questions during and after the meeting. Because of the COVID-19 pandemic, we had to make changes to last year's AGM and held it behind closed doors in order to safeguard our shareholders, employees, the Board and the wider community. We maintained shareholder participation by inviting shareholders to submit questions via email before the meeting and submitting proxy instructions electronically. Details of this year's AGM can be found in the Notice of Meeting.

Any changes to the AGM arrangements will be announced on our website at www.renishaw.com/en/agm-21987 and, if appropriate, by RNS announcement.

Separate resolutions are proposed for each substantially separate issue, and all resolutions are taken on a poll. We report on the number of votes lodged on each resolution, the balance for and against each resolution and the number of votes withheld. This information is published via a Regulatory Information Service (RIS) and on our website following the meeting.

At our 2020 AGM, the Board was again pleased that the majority of resolutions were passed with a high level of support from shareholders. The Board has considered the votes against resolutions 5, the re-election of Sir David McMurtry (24.98%) and 6, the re-election of John Deer (24.32%). In order to better understand the reasons for these votes against, the Board has considered the views of shareholders and proxy voting agencies as to voting and voting recommendations respectively (where these had been made available to the Company for the 2020 AGM including through engagement with the General Counsel & Company Secretary or through the year via the Senior Independent Director). The Board will continue to engage with shareholders to understand their views on this and any other significant matter and published an update as required under the Governance Code at www.theia.org/public-register.

Cautionary note and safe harbour: this Annual Report has been prepared for the purpose of assisting the Company's shareholders to assess the strategies adopted by the Company and the potential for those strategies to succeed and no one, including the Company's shareholders, may rely on it for any other purpose.

This Annual Report has been prepared on the basis of the knowledge and information available to the Directors at the time. Given the nature of some forward-looking information, which has been given in good faith, the Company's shareholders should treat this information with due caution.

Directors' Corporate Governance Report continued

There are also Q&A sessions with the Executive Chairman, Chief Executive and Group Finance Director as part of the full and half-year results webcasts. The Board regularly reviews our investor relations policy. Our overall approach to shareholder engagement is set out on pages 46-47.

Employee whistleblowing

We have a whistleblowing policy, facilitated by a confidential global hotline service, known as 'Speak Up', and we encourage our colleagues to raise any matters of concern about suspected unlawful or unethical conduct. We follow up all calls to our whistleblowing line. The Board monitors the operation of this policy and considers reports on concerns raised as appropriate.

Conflicts of interest

The Board has a conflicts of interest policy and a register of situational conflicts, with procedures for the disclosure and review of any conflicts and potential conflicts, and authorisation by the Board (if considered appropriate). We review all authorisations granted, and their associated terms, every year. New disclosures are made where applicable.

2. Division of responsibilities

Governance structure

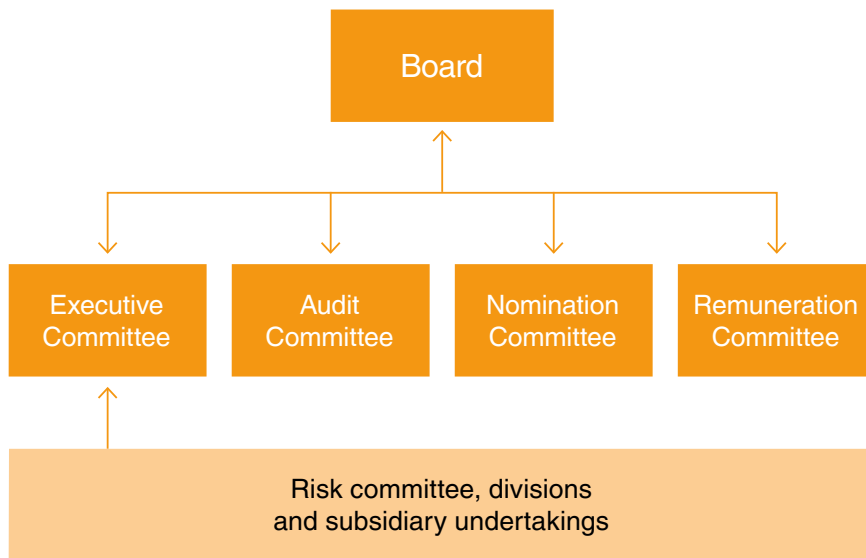

Composition of the Board

The Governance Code recommends that at least half the board, excluding the chairman, should comprise independent non-executive directors. The Board currently comprises two Executive Directors in addition to the Executive Chairman and five Non-executive Directors, four of whom are considered independent.

Carol Chesney, Catherine Glickman, Sir David Grant and John Jeans are considered by the Board to be independent in character and judgement and there are no other relationships or circumstances that are likely to affect their judgement. Both Sir David Grant and Carol Chesney have served as Independent Non-executive Directors for more than nine years. As such, we carried out a rigorous review to assess their independence, effectiveness and commitment. In particular, the Board scrutinised the factors relevant to the determination of their independence. The Board considers that Sir David Grant and Carol Chesney continue to be independent in character and judgement and that there are no relationships or circumstances which are likely to affect, or could appear to affect, their judgement.

The Board considers that all the Non-executive Directors demonstrate commitment to their roles and dedicate sufficient time to their Company duties. Their contribution, skills and experience are summarised in their biographies on pages 60-61.

Sir David McMurtry has held the position of Executive Chairman since we listed in 1984. Following careful consideration of provision 19 of the Governance Code relating to a chairman's tenure, the Board concluded that Sir David's continued service as Executive Chairman is in the best interests of the Company and its shareholders. This is because of his unique history as a co-founder of Renishaw, his contribution to our long-term sustainable success, in particular given his role and responsibilities for Group innovation and product strategy, and his continued effective leadership of Renishaw's Board.

Senior Independent Director and Non-executive Directors

Sir David Grant is the Senior Independent Director. He is available to discuss material concerns with shareholders including if the normal channels of the Executive Chairman, the Chief Executive or the Group Finance Director fail to resolve any shareholders' concerns. The Non-executive Directors meet with the Executive Chairman without the other Executive Directors present, and the independent Non-executive Directors also meet without the Executive Directors, Executive Chairman or other Directors present, to discuss performance, corporate governance and other matters.

Division of responsibilities

The Board considered that there was a clear division of responsibilities at Board level throughout the year, ensuring an appropriate balance of power and authority so there is no one person with unfettered powers of decision-making. The Board and Executive Committee each meet on a regular basis to make decisions of significance to our business segments and review management actions.

Written statements of the Chief Executive's and the Executive Chairman's key responsibilities, which also detail the key responsibilities of the Senior Independent Director, are available on our website at: www.renishaw.com/corporategovernance.

The Board of Directors

The biographies of the Directors holding office at the date of this report can be found on pages 60–61. More extensive biographies are available online at: www.renishaw.com/en/board-of-directors-and-company-secretary--21878.

There is a formal schedule of matters reserved for the Board. These include:

- the approval of annual and interim results and trading statements;
- company and business acquisitions and disposals;
- major capital expenditure;
- borrowing facilities;
- reviewing the effectiveness of workforce engagement mechanisms;
- reviewing whistleblowing policy and processes;
- ensuring maintenance of a sound and effective system of internal control and risk management;
- business plans and budgets;
- material agreements;
- director and company secretary appointments and removals;
- patent-related disputes and other material litigation;
- forecasts; and
- major product development projects.

This year, the Board met for seven scheduled meetings and five unscheduled meetings (relating predominantly to the FSP), and the Directors' attendance record at Board and Committee meetings is set out in this report. In addition to formal Board meetings, the Directors have had regular weekly or bi-weekly informal catch-up calls, which were first introduced during the COVID-19 pandemic. In addition, the Non-executive Directors met without Executive Directors present during the year. See page 66 for a high-level summary of the subjects the Board discussed during the year.

The Board has three formally constituted Committees – the Audit Committee, the Remuneration Committee and the Nomination Committee. There is also the Executive Committee, which is responsible for the executive management of our businesses. It is chaired by the Chief Executive and includes the Executive Directors and senior managers as noted on page 62. The Executive Committee usually meets in advance of Board meetings and considers the performance and strategic direction of our operating segments and other matters of general importance to the Group.

A framework of delegated authorities maps out the structure of delegation below the Board and includes the matters reserved to the Executive Committee and the level of authorities given to management below the Executive Committee.





The formal schedule of matters specifically reserved for the Board and the terms of reference for each of the Nomination Committee, Audit Committee, and Remuneration Committee are available on our website at: www.renishaw.com/corporategovernance.

Scheduled Board and Committee meetings in the year

July 2020 A A* N R R	August 2020 A B B* B*
September 2020 B*	October 2020 B N R*
November 2020 B R*	December 2020
January 2021	February 2021 A B B* R*
March 2021 B B* N R	April 2021
May 2021 A B R	June 2021 B R

* Unscheduled meeting

Key

-  Board
-  Audit Committee
-  Nomination Committee
-  Remuneration Committee

Directors' Corporate Governance Report continued

Summary of subjects discussed by the Board during the year

Strategy

- FSP
- COVID-19 pandemic
- Purpose, vision, and corporate strategy
- Divisional strategies and objectives
- Products and intellectual property – including new products
- Strategic risks
- Five-year plan
- Quality metric
- Productivity initiatives and accountability

Risk

- Supply chain dependencies
- Group's risk analysis and process evolution – including risk appetite
- Data protection and privacy

Governance

- Board effectiveness review
- Indemnification of Directors
- Business organisation and structure, including subsidiary governance
- Draft Annual Report

Finance

- Dividend policy
- Forecasts, objectives, targets, budgets and costs
- Financial performance across the Group
- Oversight of the preparation and management of the financial statements
- Hedging policy
- Tax strategy and updates
- Trading statements

Shareholder engagement

- AGM and other shareholder feedback
- Communications with shareholders

People

- Health and safety programme and updates
- Diversity and inclusion
- Talent and succession planning
- Salary reviews, bonus and pensions
- Organisational changes
- Gender pay gap
- Implications of COVID-19

Board and Committee meeting attendance record

The table below shows the number of scheduled and unscheduled meetings of the Board and its Committees that Directors attended, and the number of meetings they were eligible to attend during the year. During the pandemic and FSP, the Board held additional weekly or bi-weekly calls as part of its planning process and continues to hold regular progress calls where necessary to consider any other urgent matters.

Commitment

The terms of appointment of the Non-executive Directors, which includes the expected time commitment and requirement to discuss any changes to other significant commitments with the Executive Chairman and Chief Executive in advance, are available for inspection at the AGM and the registered office upon written request.

None of the Executive Directors holds a directorship in a FTSE 100 company.

Development

Directors are offered the opportunity to attend formal training courses regarding their duties as Directors. Guidance notes, papers and presentations on changes to law and regulations are provided as appropriate. Non-executive Directors are invited to attend internal conferences, providing information on new product development and marketing initiatives, to meet with business units and functions, as well as attending investor days. Business presentations are given at Board meetings (for example by heads of product lines and regions) to give updates on, and opportunities to discuss, products and business strategies.

A tailored induction pack is given to new Directors, and the induction programme (together with the continuing development programme) includes site visits and briefings by senior managers, attendance at internal senior management conferences and external trade shows, as well as overseas subsidiary visits, as applicable.

Information and support

The Board receives business updates, financial information and forecasts with relevant commentaries in advance of each Board meeting. These allow Directors to review financial performance, current trading and key business initiatives. All Directors have access to the General Counsel & Company Secretary (who advises the Board on all governance matters) and, where necessary, to independent professional advice at the Company's expense to discharge their responsibilities as Directors. We maintain liability insurance for our Directors and officers and have entered into indemnities with each director (excluding the founders) as disclosed in the Other statutory and regulatory disclosures on page 94.

Director	Board	Audit Committee	Remuneration Committee	Nomination Committee
David McMurtry	12/12			3/3
John Deer	12/12			
Will Lee	12/12			
Allen Roberts	12/12			
Carol Chesney	12/12	5/5	8/8	3/3
Catherine Glickman	12/12	5/5	8/8	3/3
David Grant	12/12	5/5	8/8	3/3
John Jeans	12/12	5/5	8/8	3/3

3. Composition, succession and evaluation

Nomination Committee

We set out a description of the structure and activities of the Nomination Committee, as well as the Board's commitment to diversity, in the Nomination Committee Report on pages 68–70.

Re-election

In accordance with the Governance Code all the Directors retire from the Board at each AGM and offer themselves for re-election.

4. Audit, risk and internal control

Audit Committee

We set out a description of the membership and activities of the Audit Committee in the Audit Committee Report on pages 71–76.

Financial and business reporting

We explain the respective responsibilities of the Directors and auditor in connection with the financial statements in the Directors' responsibilities section on page 97 and the Independent Auditor's Report on pages 98–106.

Risk management and internal control

The Board is responsible for our systems of risk management and internal control, and for reviewing their effectiveness. Any system of internal control is designed to manage rather than eliminate the risk of failure to achieve business objectives and can only give reasonable, but not absolute, assurance against material misstatement or loss.

There are defined lines of responsibility and delegation of authorities. We also have established and centrally documented control procedures, including approvals of capital and other expenditure, information and technology security and legal and regulatory compliance. These are applied throughout the Group.

Our Internal Audit function gives independent and objective assurance that the control procedures are appropriate and effectively applied. The Group Internal Audit Manager attends Audit Committee meetings to present annual internal audit plans and the results of such audits. The Audit Committee monitors actions on an ongoing basis.

We have an established process for the review of business risks throughout the Group including our risk committee as explained in the Risk management section on pages 30–43.

The Board ensures we have effective internal controls over the financial reporting and consolidation processes. Monthly accounts and forecasts are presented to the Board for review. Our internal audit function carries out a review of subsidiaries' accounting processes and performance to give assurance to the Board on the integrity of the information supplied.

The Board reviews the effectiveness of our system of internal controls and carries out an updated risk and controls analysis every year. The review covers material controls, including financial, operational and compliance controls and risk management systems.

The Board has conducted a robust assessment of the principal and emerging risks that we face, including those that would threaten our business model, future performance, solvency or liquidity. Our principal risks and uncertainties can be found on pages 34–43. The Board is satisfied that there is an ongoing process for identifying, evaluating and managing the significant risks that we face. This is regularly reviewed and accords with the FRC Guidance on Risk Management, Internal Control and Related Financial and Business Reporting. The Board verifies that necessary action has been or is being taken to remedy any significant failings or weaknesses identified from its review.

Going concern

During the year the Directors assessed the Group and Company's position as a going concern, and updated this assessment prior to signing this report. The Directors have determined that at the time of approving these financial statements there is a reasonable expectation that the Group and the Company have adequate resources to continue in operational existence for a period of at least 12 months from the date of this report. This assessment is explained in more detail in note 1 of the Consolidated financial statements, on page 118.

Viability statement

The Board approved the Company's viability statement on page 44.

5. Remuneration

In the Directors' Remuneration Report, we explain how we apply the Governance Code principles relating to remuneration and we include a description of the membership and activities of the Remuneration Committee on pages 77–93.

Compliance statement

The Board considers that it has complied with the provisions of the Governance Code throughout the year except in relation to provision 19 (that the chair should not remain in post beyond nine years from the date of their first appointment) and a full explanation of the reasons for this is given on page 64 and page 70.

Sir David Grant

Senior Independent Director

21 October 2021

Nomination Committee Report

Overview



The FSP affected our Board succession planning this year. Now that the process has concluded, the Committee will renew its focus on ensuring the Board has the right balance of experience, skills and diversity to support the Company in achieving its strategy.”

Sir David McMurtry
Chair of the Nomination Committee

Board succession planning

One of the key activities proposed for this year was progressing the Board’s succession plans for recruiting additional Non-executive Directors in particular, in light of the tenure of Sir David Grant and Carol Chesney, as discussed on page 64. A process was started in July 2020, led by the Senior Independent Director, Sir David Grant, and supported by the Chair of the Remuneration Committee, Catherine Glickman. This process was put on hold when the Board first discussed and agreed to launch the FSP having been informed by the founders of their decision to sell their shareholding in the Company. The FSP was subsequently concluded in July 2021.

Board succession planning was affected this year by the FSP. Now that this process has concluded, the Committee will renew its focus on ensuring the Board has the right balance of experience, skills and diversity going forward to support the Company in achieving its strategy. The Board intends to recruit and appoint at least two new Non-executive Directors.

Board effectiveness review

The Board undertakes an annual evaluation of its performance and effectiveness.

In 2019, an external, independently-facilitated Board effectiveness evaluation was conducted by Equity Communications Limited. In both 2020 and 2021 internal review processes were conducted. The next external review is scheduled for 2022, as set out in the diagram opposite showing the three-year cycle of internal and external reviews.

Committee members	Attended
Sir David McMurtry (Chair)	3/3
Sir David Grant	3/3
Carol Chesney	3/3
John Jeans	3/3
Catherine Glickman	3/3

Committee composition

The Committee comprises the Chairman, Sir David McMurtry, and the four independent Non-executive Directors; Sir David Grant, Carol Chesney, John Jeans and Catherine Glickman.

Only Committee members are entitled to attend meetings, although the Chief Executive is a regular attendee (excluding where his role is being discussed). Details of attendance at meetings is shown above.

Principal role and responsibilities

The Committee is appointed by the Board and operates under the terms of reference published on our website at www.renishaw.com/corporategovernance, which are reviewed annually.

The primary duties of the Committee are:

- reviewing the size, structure and composition – including the balance of skills, knowledge, experience and diversity – of the Board and its Committees, and recommending changes to the Board, as appropriate;
- overseeing succession planning for the Board and other senior executives;
- leading the process for new Board appointments and nominating candidates for appointment to the Board;
- reviewing the independence and requirements of Non-executive Directors every year; and
- monitoring the leadership needs of the Group, including for Directors and other senior executives.

Board evaluation: three-year cycle

Year 1: Internal 2020

- Co-ordinated internally by the company secretarial team.
- Questionnaire based on outcomes from previous external review.
- Anonymised results discussed at Board meeting and outcomes and actions agreed.

Year 2: Internal 2021

- Co-ordinated internally by the company secretarial team.
- Questionnaire based on outcomes from previous internal evaluation.
- Anonymised results discussed at Board meeting and outcomes and actions agreed.

Year 3: External 2022

- Independent external evaluator appointed.
- Evaluation conducted via interviews with Directors.
- Report prepared by independent evaluator which the Board reviews and agrees outcomes and actions.

Internal review process

During the year an internal Board effectiveness review was conducted by the company secretarial team. The review consisted of a questionnaire, covering a number of areas such as strategy, succession and talent, conduct of Committees, and content and effectiveness of Board meetings. The questions were partly based on the output from the 2020 review, together with feedback from the Board on that process. The questionnaire was distributed to the Board in May, and all eight Directors responded. The responses were consolidated and anonymised, and the results and key themes set out in a summary report. The recommendations were set out in an action plan based on the findings in the report. Both the report and the action plan were reviewed and discussed by the Board at its meeting in June.

The outcome of the evaluation confirmed that the Board and its Committees continued to operate effectively.

Key findings from the 2021 review

It was noted the following areas had improved following the 2020 review:

- definition, clarity and communication of our strategy and objectives;
- timeliness and content of agendas and papers; and
- communication between Board meetings with the weekly calls.

The main recommendations from the 2021 evaluation included:

- continued focus on timeliness, length and quality of papers;
- increased time for Q&A with presenters on key topics; and
- increased number of specific sessions on executive talent management.

Areas of focus for the year ahead

These include:

- renewed focus on Board succession planning, and talent management and succession planning at senior executive level, and across the wider Company;
- continued focus on diversity and inclusion; and
- implementing the recommendations from the 2021 Board effectiveness review.

Boardroom diversity

The Board recognises the importance and value of all forms of diversity, including gender, age, ethnicity and background, as well as the importance of creating a culture of inclusion. Our aim is for the Board to have a diverse range of skills, experience and thought from individuals who can really add value to the business and help us to develop and achieve our strategic goals.

The proportion of women on the Board is currently 25%. The Board supports the aspiration of gender diversity, and best practices in this area, as set out in the Hampton-Alexander review (with a target of 33%), as well as the aspiration of ethnic diversity set out in the Parker Review.

With Non-executive Director succession planning a key activity for the Board in the coming year, the Board will have the opportunity to review its composition following the conclusion of the FSP, with a focus being the diversity of its members.

We recognise the benefits of a diverse Board and are in the process of updating our Equality, Diversity and Inclusion Policy which, if approved, will apply to the Group and the Board. The new policy follows the formation of a D&I working group, and Board approval for the new policy will be sought in October 2021. The policy, if approved, will confirm our commitment to develop, maintain and support an equal and diverse workforce both in the UK and internationally.

The main objective of the policy will be to establish an inclusive culture, free from discrimination, harassment and victimisation. The new policy will also help us to achieve some of our strategic objectives, including creating an inclusive culture with a diverse workforce and Board and building on our reputation as a responsible business.

Board composition

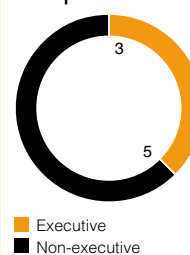

Gender

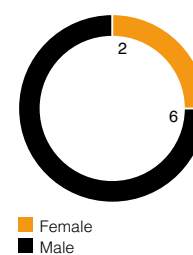

Age

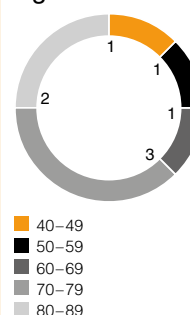

Tenure

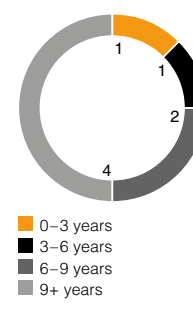

Nationality

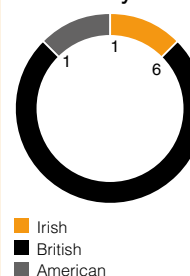

Nomination Committee Report continued

Board appointment process

The Board has an established process for identifying and evaluating candidates for appointment to the Board and senior management. Board appointments are also subject to the principles in our draft Equality, Diversity and Inclusion Policy and which formalises our commitment to diversity at all levels. The Committee's procedures expect members to:

- evaluate the balance of skills, knowledge, experience and diversity on the Board;
- identify the skills, knowledge and experience required;
- agree a role specification for the proposed appointment;
- select and appoint recruitment consultants to produce a longlist of diverse candidates for the Committee's consideration, if the position is not to be filled internally;
- review candidate profiles and prepare a shortlist of diverse candidates for interview;
- consider and take forward candidates on merit and against objective criteria, with due regard to the benefits of diversity on the Board; and
- recommend the preferred candidate to the Board.

Senior management diversity

Following some changes to the Executive Committee during the year, there were eight men and one woman on the Committee for most of the year (11% women), and there are now seven men and one woman. There were previously no women on the Executive Committee, so the appointment of Jacqueline Conway in November 2019 was welcomed by the Nomination Committee. Across senior management and our subsidiary directors which, in accordance with the UK Corporate Governance Code, comprises the Executive Committee and their direct reports (excluding those in administrative or non-managerial roles), there are 49 men and four women (8% women). The gender split for both the Executive Committee and senior management are included in the table set out below.

For the engineering sector to reach its full potential, it is important that it reflects the society in which it operates. The Committee will continue to focus on improving all forms of diversity at senior management level across the Group.

Sir David McMurtry

Chair of the Nomination Committee

21 October 2021

Management level	Male	Male %	Female	Female %
Board	6	75	2	25
Executive Committee	7	88	1	12
Senior managers and subsidiary directors ¹	50	93	4	7

¹ As defined by the Companies Act 2006.

Tenure of the Chairman

The Governance Code issued by the FRC in July 2018 sets out the governance principles that applied to the Company during the 2021 financial year. We complied with all the principles of the Code in 2020 with the exception of Code Provision 19. This Code Provision recommends that the Chairman should not remain in post beyond nine years from the date of his first appointment to the Board. This provision was introduced for the first time for accounting periods beginning on or after 1 January 2019.

Our Executive Chairman, Sir David McMurtry, co-founded Renishaw together with John Deer in 1973. Sir David was appointed to the Board in September 1975 and has been Executive Chairman since the Company listed in 1984. He also served as Chief Executive from 1975 to 2018, when Will Lee was appointed.

While Sir David's tenure exceeds the nine years recommended under the Code, his length of service reflects that he continues to be a major driver of innovation and growth in the business. He is focusing on the next-generation project for additive manufacturing which will help to ensure Renishaw becomes a technical leader for selected applications within this field. Sir David's stewardship throughout the FSP, together with his unique skills, experience, and knowledge of the industry, explains the rationale for his lengthy tenure and the unanimous support of the rest of the Board for him remaining in post.

Audit Committee Report

Overview



The Audit Committee enhanced its oversight during the past 18 months, building on the additional Board meetings that were held during the COVID-19 pandemic. This extended into the Board's preparation for the FSP and involved a detailed review and update of the operational structure, and the business plan and strategy.”

Carol Chesney
Chair of the Audit Committee

How we operate

Role and composition

The Audit Committee is appointed by the Board from our Non-executive Directors. The Audit Committee's terms of reference include all matters indicated by Disclosure and Transparency Rule 7.1 and the Governance Code.

The terms of reference are reviewed annually by the Audit Committee. Any changes are recommended to the Board for approval. The terms of reference are available on our website.

The Audit Committee reviews our accounting policies and procedures, annual and interim financial statements before submission to the Board and compliance with statutory requirements. The Audit Committee monitors the integrity of our financial statements and announcements relating to financial performance, and reviews the significant reporting judgements contained therein. It also reviews the scope, remit and effectiveness of the internal control systems and internal audit function and, together with the risk committee and the Board, reviews the effectiveness of our risk management systems.

The Audit Committee comprises four Non-executive Directors: myself (Chair), Sir David Grant, John Jeans and Catherine Glickman. The Board is satisfied that I have recent and relevant financial experience and that collectively, the Committee has a depth of financial and commercial experience in various industries, as well as sectors in which the Group operates. A more detailed summary of the qualifications, skills and experience of each Committee member can be found on pages 60 and 61.

Committee meetings

The Committee meets a minimum of four times a year with the Chief Executive, the Group Finance Director, the Head of Group Finance, the Group Financial Controller, the General Counsel & Company Secretary (together, the executives), the Group Internal Audit Manager and the external auditor in attendance. After each meeting, the Committee holds separate discussions with the external auditor and the Group Internal Audit Manager, without the executives.

The executives work closely with me to ensure that transparency is maintained in setting the agenda, determining the required meeting papers and setting the appropriate level and timeliness of communications among Committee members between meetings. This also ensures that the Committee has or attains additional practical industry knowledge to aid discussions in and around meetings.

I give feedback on significant matters considered during meetings to the Board after each Committee meeting.

Committee effectiveness

As noted on page 69, an internal Board effectiveness review was carried out during the year by our company secretarial team. This review included the effectiveness of the Audit Committee. Overall, the review found that the Committee continued to be effective. The review also identified areas of focus for the year ahead including:

- seek to improve and address other areas of concern to the Committee; and
- invite business leaders to present to the Committee regarding unresolved audit matters.

Audit Committee Report continued

Main areas of focus

To ensure that relevant matters are fully considered, the Committee has a programme of agenda items, supplemented by items of significance that may arise during the year. Some of the matters discussed by the Committee during the year are summarised below.

Main areas of focus during 2021

Financial statements

- Reviewed our 2021 Annual Report, 2021 Interim Report and trading updates and reported back to the Board before their announcement. Reviews included the receipt and discussion of detailed reports and presentations from management and the external auditor.
- Reviewed management's work in respect of the risks that could challenge our future performance or liquidity forecasts. This included an assessment of the scenarios used to support the going concern assessment, the viability statement and the related disclosures.
- Received and discussed reports from the Group Finance Director and Head of Group Finance on accounting judgements, estimates and financial reporting issues relevant to the consideration of our financial statements.
- Conducted a fair, balanced and understandable review of the 2021 Annual Report.

External audit

- Reviewed, considered and agreed the scope and methodology of the 2021 audit work carried out by the external auditor for the full year and agreed EY's fees.
- Received regular reports from EY on the results of their work including a high-level report ahead of the interim results announcement and a detailed report ahead of the full-year results announcement.
- Reviewed EY's independence, objectivity and effectiveness, the latter by way of a questionnaire completed by Finance team members in the UK and subsidiaries where EY is the auditor.
- Reviewed the level of non-audit services provided by EY and the related policy.
- Met with the audit partner privately after each Audit Committee meeting.

Risk management and internal controls

- Reviewed the risk committee's work to identify our principal and emerging risks.
- Monitored the effectiveness of our internal controls and fraud risk.
- Reviewed the risk management and internal control disclosures in the Annual Report and Interim Report.
- Considered the potential impact of COVID-19 on the control environment and received regular updates.
- Considered the potential effect of the FSP process on the control environment and the financial reporting timetable. Agreed to extend the reporting timetable to ensure that senior management had sufficient availability to consider judgements and estimates.

Internal audit

- Reviewed and approved the Internal Audit plan for 2021, including the scope of work and changes made to the audit process due to COVID-19.
- Regularly received and discussed reports from the Group Internal Audit Manager on the function's work.
- Considered management's responses and their timeliness to audit recommendations during the year for the most significant recommendations.
- Met with the Group Internal Audit Manager privately after each Audit Committee meeting.

Financial reporting, and critical judgements and estimates

The Committee considers the issues below as the most significant in relation to this year's financial statements. Each of these has been discussed and reviewed with management and the external auditors. Management's judgements were reviewed and challenged and the Committee obtained further information where needed.

Item	Description	Our review and conclusions
Cash flow hedges	<ul style="list-style-type: none"> – In relation to the forward currency contracts in a designated cash flow hedge, the hedged item is a layer component of forecast sales transactions. If the revenue forecasts fall, such that these hedged items are no longer highly probable, or more likely than not to occur, then this item is no longer eligible for hedge accounting. This would mean that some of the movements in fair value would be recognised through the Consolidated income statement rather than the Consolidated statement of comprehensive income and expense. 	<ul style="list-style-type: none"> – We reviewed and challenged the revenue forecasts that support the hedge effectiveness calculations. The forecast revenues have increased compared with the forecasts prepared last year due to the improvement in trading conditions we have seen in the second half of 2021. We satisfied ourselves that there was no further ineffectiveness this year. We also agreed with the accounting entries made.
Goodwill and capitalised development costs	<ul style="list-style-type: none"> – Goodwill and capitalised development costs are subject to an annual impairment review. Determining whether there is an impairment requires an estimation of the future cash flows of cash-generating units and the selection of appropriate interest rates. 	<ul style="list-style-type: none"> – We reviewed and challenged the revenue and profit forecasts, and discount rates that support the carrying value of the goodwill and capitalised research and development costs. We agreed with the conclusions reached and the accounting entries and disclosures made.
Research and development costs	<ul style="list-style-type: none"> – Judgement is needed as to whether expenditure on research and development activities meets the requirement to be capitalised. 	<ul style="list-style-type: none"> – We reviewed the projects that are capitalised and agreed with the conclusions reached and the accounting entries and disclosures made.
Inventories	<ul style="list-style-type: none"> – Management estimates of future demand are used to determine the net realisable value of slow-moving and potentially obsolete inventory. – Management use historic usage levels (capped at 18 months), demand from customer orders and manufacturing build plans as a basis for estimating the future annual demand of individual stock items. – For further information please see note 1 of the consolidated financial statements on pages 113–120 and the independent Auditor's Report on pages 98–106. 	<ul style="list-style-type: none"> – We considered the level of provisions and the appropriateness and application of the policy, ensuring consistency across the Group in the current and previous financial periods. – We also sought the views of our external auditor. – Following our review, which included consideration of the external audit findings, we concluded that the £17.4m provision for obsolete and slow-moving inventory was consistently calculated on a prudent basis, appropriate and fairly stated in the consolidated financial statements.

Audit Committee Report continued

Item	Description	Our review and conclusions
Defined benefit pension schemes	<ul style="list-style-type: none"> – Determining the value of the future defined benefit obligation requires estimation in respect of the assumptions used to determine the present values. These include future mortality discount rate and inflation. Management makes these estimates in consultation with independent actuaries. For further information please see note 1 of the consolidated financial statements on pages 113–120 and the independent Auditor's Report on pages 98–106. – In October 2020 the Trustees of the UK defined benefit scheme notified the Company of a difference between the calculation of liabilities in the scheme for administration purposes and for accounting purposes. The jointly obtained Queen's Counsel's (QC) opinion resulted in a reduction in scheme liabilities of £14.3m. This has been treated as a change in accounting estimate in 2021, and the change mostly relates to benefits in future years. See note 22 for further details. 	<ul style="list-style-type: none"> – We reviewed the assumptions made and sought the views of our external auditor. Following our review, which included the external audit findings, we agreed with the conclusions reached and the accounting entries and disclosures made. – We received reports provided to the Company by external advisers, covering the opinions of the various advisers and QC and the effect on scheme liabilities. We also reviewed management's assessment that the change to liabilities resulted from a change in accounting estimate in 2021 and discussed this with the external auditor. We agreed with the conclusions reached and the accounting entries made.
Taxation	<ul style="list-style-type: none"> – Deferred tax assets are recognised to the extent it is probable that future taxable profits will be available and are based on management's assumptions relating to the amounts and timing of future taxable profits. Estimates of future profitability on an entity basis are needed to ascertain whether it is probable that sufficient taxable profits will arise to support the recognition of deferred tax assets relating to the corresponding entity. 	<ul style="list-style-type: none"> – We reviewed and challenged the revenue and profit forecasts in relation to the entities for which a deferred tax asset is recognised and agreed with the conclusions reached and the accounting entries and disclosures made.

Fair, balanced, and understandable assessment

As an Audit Committee, we have reviewed management's process for ensuring that this Annual Report is fair, balanced, and understandable. This process involved:

- engaging corporate reporting specialists to review the 2020 Annual Report and provide recommendations for improvement in 2021;
- ensuring that the fair, balanced and understandable requirements were a key part of the Annual Report project team's planning workshop;
- reiterating these requirements to the project team throughout the preparation and review process;
- involving senior management and the Board in preparing and reviewing the Annual Report, and explicitly asking whether they felt that the Annual Report was fair, balanced, and understandable;
- having the non-financial information verified by a member of Group Finance who was independent from the preparation of this information; and
- engaging our remuneration and legal advisers, and corporate reporting specialists, in reviewing the Annual Report.

We were satisfied with this process, and following discussions at our September 2021 Committee meeting we advised the Board that the Annual Report, taken as a whole, is fair, balanced and understandable, and that it provides the necessary information for shareholders to assess the Company's position and performance, strategy and business model.

Risk management and internal controls

The Board has overall responsibility for setting the Group's risk appetite and ensuring that there is a robust internal control environment and effective risk management processes. The Board delegates responsibility for risk management to an executive committee. Responsibility for oversight of the effectiveness of risk management and the internal control systems has been delegated to the Audit Committee.

The main features of our internal control and risk management systems, and the Committee's oversight of them, are summarised below.

Internal audit

The Internal Audit team reports and follows up on control and operational weaknesses, and supports management in making improvements where needed. An annual declaration of compliance with internal controls and processes is completed by senior management from each active Group company. Internal Audit continues to review and develop its work programmes to match the evolving risk landscape. Due to COVID-19, we had to carry out all 24 overseas subsidiary audits remotely. The standard work programme has been used for all audits in the year, with physical checks being undertaken using electronic screen-sharing tools with employees from the respective subsidiary team. We expect to continue carrying out remote overseas subsidiary audits throughout the 2022 financial year, supported by the respective subsidiary team where needed.

Internal audit effectiveness

The Committee reviewed the effectiveness of the internal audit function through discussion with the Group Finance Director, the Head of Group Finance, members of the Audit Committee and a questionnaire completed by subsidiary finance teams audited in 2021.

When the Committee assesses the effectiveness of the function and the quality of its work throughout the year it considers:

- the progress on recommendations brought forward and raised during 2021;
- the audit plan and how it was delivered;
- the way in which audit findings are communicated to the Committee;
- meetings with the Group Internal Audit Manager without management present; and
- feedback from senior management as well as a questionnaire completed by subsidiary finance teams.

The Committee concluded that the function continues to operate effectively.

Risk management

The Committee monitors the effectiveness of our internal controls and risk management processes with support from Internal Audit and the risk committee. This gives Committee members a good understanding of the business performance and key areas of judgement and decision making within the Group.

During the year, the risk committee introduced a new bottom-up process for which risk reports are submitted by the subsidiaries and product divisions; this has created an improved central repository of risk data from across the Group.

Each principal risk has a risk owner who is responsible for managing and tracking their respective risk. A number of risk owners have presented to the risk committee, Audit Committee or Board during the year.

The Committee also reviewed management's work in preparing our Viability statement, which can be found on pages 44-45, at its meeting in September 2021.

Internal control environment

Our internal control systems are designed to manage rather than eliminate risk and can only give reasonable, but not absolute, assurance that risks are managed to an acceptable level. Their effectiveness is dependent on regular evaluation of the extent of the risks to which we are exposed.

In relation to the financial reporting process, at the business level, line management is required to implement base financial and other controls in line with a clear set of detailed policies relating to financial reporting and other accounting matters. They are required to act in accordance with the Group Business Code. Our Group Finance function oversees our financial reporting process. This includes setting our financial policies and discussing any matters arising with the Internal Audit function from the annual self-certification process completed by each operating company. At a further level, assurance functions (Internal and External Audits) test various aspects of the processes and report to the Committee.

During the year, the Committee monitored and reviewed the effectiveness of our internal control systems, accounting policies and practices, standards of risk management and risk management procedures and compliance controls. It also reviewed the Company's statements on internal controls, before they were agreed by the Board for this Annual Report. The Committee receives regular reports throughout the year to assure itself that our systems comply with the requirements of the Code. The Committee can confirm that our systems have been in place for the full financial year up to the date on which the financial statements were approved, and that they are effective and regularly reviewed by the Committee on behalf of the Board.

Audit Committee Report continued

External audit

During the year, the audit partner attended all Committee meetings and gave the Committee information and advice including detailed reports on the financial statements, critical accounting judgements and estimates and the internal control environment.

The terms, areas of responsibility and scope of EY's 2021 audit were reviewed and approved by the Committee. During the year, EY provided external audit services for regulatory and statutory reporting. EY is expected to report material departures from Group accounting policies and procedures identified in the course of their work to the Committee. At the date of this report, EY's 2021 external audit plan has been successfully completed and their independent Auditor's Report can be found on pages 98–106.

Effectiveness

The Committee continues to monitor EY's audit approach by way of updates at Audit Committee meetings and further routine discussions between the Committee Chair, the executives, the Group Internal Audit Manager and senior representatives of EY.

When the Committee assesses the effectiveness of the external auditor and the quality of the audit work throughout the year it considers:

- any issues arising from the previous year's audit;
- the proposed audit plan identifying Group-specific risks, audit scope and materiality thresholds;
- the delivery of the audit in line with the plan;
- the way in which any issues raised by the audit are communicated to the Committee;
- meetings with the external auditor without management present;
- the independence and objectivity of our auditor; and
- feedback from executive management as well as a questionnaire completed by UK and subsidiary finance teams.

The Committee concluded that the external audit process is effective.

Independence and objectivity

The company has policies and procedures in place to ensure that the independence and objectivity of our auditor is not impaired. These include restrictions on the types of services which our auditor can provide, in line with the Audit Practices Board Ethical Standards on Auditing ("Ethical Standard"). EY also provides assurance on the processes and controls it has in place to maintain its independence and objectivity. These include an internal process that requires the audit partner to pre-approve the provision of non-audit services and the use of separate teams where non-audit services are being provided. This internal process also includes an assessment of the proposed services against the Ethical Standard. We remain satisfied that these processes are robust and with the independence and objectivity of EY.

Non-audit services policy

In order to safeguard the independence and objectivity of the external auditor, the Committee reviews the nature and extent of the non-audit services supplied, receiving reports on the balance of audit to non-audit fees. The non-audit services policy reflects the extended list of prohibited services as set out in the latest EU audit regulation. There are also specified services that need the prior approval of the Group Finance Director and Chair of the Audit Committee before the auditor may be appointed to provide such services. In addition, specific levels of authorisation are needed before the auditor may tender for non-audit services.

Audit and non-audit fees

For 2021, the external auditor provided £12,000 of non-audit work in relation to separate pieces of work regarding Wotton Travel's annual ATOL/ABTA reporting, IATA reporting, French tax compliance and an export certificate for our Indian subsidiary. An analysis of fees paid to EY is included in note 6 to our financial statements.

Auditor reappointment

The Committee has primary responsibility for recommending the appointment, reappointment or removal of the external auditor, which the Board puts to shareholders for approval at the AGM. We appointed EY as our auditor at our 2016 AGM, making this the fifth year that it has audited our Annual Report. The lead audit partner, Paul Mapleston, has held the position since EY's appointment and so a new lead audit partner will be put in place for the 2022 audit.

An audit tender process is conducted at least every 10 years with consideration to conducting such a process given after five years' tenure. EY has now served for five years and, as such, the audit partner will rotate off after the completion of the formalities associated with the 2021 audit. We are currently conducting an interview process to aid the determination of the next EY audit partner which will inform our view as to whether to bring forward an external audit process sooner than 10 years.

Carol Chesney

Chair of the Audit Committee

21 October 2021

Directors' Remuneration Report

Committee Chair's statement

Overview



We continue to operate a simple and conservative reward policy, which we consider fair and prudent, taking decisions in the context of outcomes for the wider workforce.”

Catherine Glickman
Chair of the Remuneration Committee

Introduction

On behalf of the Board, I present our Remuneration Report for the year ending 30 June 2021.

This year's report has a short summary of our remuneration policy, followed by the Annual Report on remuneration. The Directors' Remuneration Report is subject to an advisory shareholder vote at our November 2021 AGM.

Remuneration in context

This reporting period continues to cover arguably one of the most challenging times for Renishaw, however, we finished the year with a record order book and particularly robust demand in the semiconductor, capital equipment and consumer electronics markets. While demand returned to our key markets from mid-June 2020, we had to adapt rapidly to keep colleagues safe, deliver for customers and manage costs. The strong performance delivered in the year is a testament to the strength of the leadership team under our Chief Executive, Will Lee, and an outstanding workforce who have shown exemplary loyalty and resilience.

Our approach of balancing the experience of employees, shareholders and other stakeholders has continued, with the resumption of dividend payments and investing in our colleagues. We continue to operate a simple and conservative reward policy which we consider fair and prudent, taking decisions in the context of outcomes for the wider workforce.

Remuneration for the year ended 30 June 2021

When we introduced COVID-19 measures in March 2020, all Board members agreed to reduce their salary and fees to mirror the experience of our employees. At that time, Will Lee accepted a 40% reduction, Allen Roberts and the independent Non-executive Directors accepted a 20% reduction and the founders, Sir David McMurtry and John Deer, chose to waive their salary/fee entirely. These were personal choices respected by the Remuneration Committee. While we reinstated Board member and employee remuneration in July 2020, our founders continued to waive their full salary/fee until July 2021.

Against this background, we did not award any base salary increases to Will Lee or Allen Roberts for the year ended 30 June 2021.

In line with the new policy approved by shareholders at the 2020 AGM, from 1 August 2020 Will Lee and Allen Roberts' pension contributions were reduced from 15% to 11%, in line with other UK employees who joined before 2007.

The Executive Directors' reward was aligned with the staff reward. There were no base pay increases for the year ended 30 June 2021, however, to reward and recognise the strong performance achieved in the 2021 financial year, bonuses were paid to all eligible employees in two ways:

- in January 2021, the Directors awarded staff worldwide a £750 'thank you' payment to recognise their contribution through the year. We also repaid the CJRS monies (£1.9m) claimed during the first half of the year and implemented a series of targeted salary awards; and
- award of the Renishaw annual bonus, paying out a UK minimum of £1,000 increasing to a maximum of 75%. Base pay increases were awarded in line with local markets: this was 2.1% in the UK, effective as from 1 July 2021.

In accordance with our remuneration policy, the maximum award under the Executive Director Annual Incentive Plan for 2021 was 150% of salary for Will Lee and Allen Roberts and 100% of salary for Sir David McMurtry. Fifty percent of any earned payout is deferred into shares for three years for Will Lee and Allen Roberts, and Sir David McMurtry's is paid as cash. As we explained last year, the Committee agreed that 90% of the Annual Incentive Plan would be awarded for financial performance, specifically, Adjusted profit before tax, and 10% would be based on strategic drivers.

On financial targets, I am pleased to say we have far exceeded the maximum for the profit range, with a full year Adjusted profit before tax result of £119.7m: this means that this element pays out in full, and the non-financial element becomes payable.

The key strategic objectives which constitute the non-financial elements of this financial year's annual incentive opportunity were as follows:

- to accelerate key new product development;
- to target investment to deliver maximum return; and
- to drive productivity and accountability through the organisational restructure and cultural alignment.

Directors' Remuneration Report continued

The Committee considers that the Executive Directors have achieved these non-financial objectives in full. We have seen accelerated progress through: focused effort on key priority projects, including a successful launch of the FORTiS enclosed encoder; strategic change initiatives across a number of the business units; tight cost control with targeted investment in key growth opportunities; R&D has been maintained, with gross engineering expenditure being 13.6% of revenue; and we have launched our vision, values and strategy worldwide. A full narrative is in the Remuneration Report on page 89.

These objectives have been achieved while demand has grown rapidly. We have managed supply chain challenges and responded to increased demand by recruiting over 300 manufacturing employees. We congratulate the Executive Directors on such a strong performance and believe the full award of the incentive is well deserved.

Our approach to Executive Director remuneration for the year ended 30 June 2022

To assess our competitive pay positioning, the Committee has reviewed market benchmark reference points with the assistance of our remuneration advisers, Deloitte LLP. We considered:

- a cross-sectoral group of 40 FTSE 350 companies above and below Renishaw (+/-20) within a 12-month average market capitalisation range of £2.780bn to £5.725bn (compared to Renishaw's £3.985bn) and excluding financial services; and
- a sector comparator group – given the limited number of direct comparators to Renishaw, the sector data was based on the FTSE 350 Industrial Goods & Services sector.

While market data gives us a valuable insight into pay levels and structures, the Committee recognises that benchmarking should not be the sole determinant when considering Executive Director remuneration. In line with Renishaw's general approach to setting pay, the Committee therefore considers many factors, alongside benchmarking, when reviewing proposed changes to remuneration packages.

Renishaw's policy remains conservative and simple, with only the Executive Director Annual Incentive Plan (up to 150% of base salary for Will Lee and Allen Roberts), and no long-term incentive plan. The Committee therefore believes that paying a competitive rate on base salary is a key consideration. However, the Committee also acknowledges that it is important that base salary increases are kept under tight control given the multiplier effect of such increases.

In the normal course of events, increases in Executive Directors' salaries are in line with the wider workforce. After due consideration, the Committee has concluded that, in line with the review of the wider UK workforce, an increase of 2.1% will be paid to Sir David McMurtry and Allen Roberts.

In considering the overall positioning of Sir David McMurtry's package, the Committee noted that he received no salary increase for the year ended 30 June 2021, and he continues to operate as the Executive Chair of Renishaw.

When Will Lee was appointed Chief Executive in February 2018, being an internal promotion, his salary was positioned below the normal market rate, with the stated intention that the Committee would make staged increases to bring the salary in line with the market, subject to performance and experience gained in the role. This is consistent with the approach we adopt for below Board roles.

Will Lee has now been Chief Executive for more than three years. During that time, he has further developed the Renishaw vision, values and strategy. He has also led the Fit for the Future initiative and navigated the Company skilfully through the pandemic. This has resulted in a year of strong profitable growth, tight cost management and acceleration of both the flagship product delivery and innovation pipeline. In the second half of the year, he led engagement with potential buyers on the FSP.

Since his appointment as Chief Executive, Will Lee has received one base salary increase, effective 1 July 2019, of circa 2%, in line with the wider workforce.

The Committee decided that any salary adjustment for the year ended 30 June 2021 would be inappropriate given the business uncertainty, salary reductions and shorter working hours, no core award or bonus for our people and suspension of the dividend.

This year, we are in a very different position and a major reason for this is the leadership of our talented Chief Executive who has risen to every challenge. We consider that Will Lee is operating very effectively in the role, adding substantial value to the Company and its stakeholders, and we wish to position his base pay accordingly. The Committee is also aware of the importance of retention and, given there is no long-term incentive, is keen to ensure that Will Lee is fairly rewarded as Chief Executive.

Over the last two years the size of the Board has also reduced when the Group Engineering Director stepped down in 2019 and John Deer moved from Executive to Non-executive in January 2020. This has not only reduced the overall costs of the Board but has increased the scope and responsibilities of the Executive Director roles.

Taking into account all of these factors, the experience he has gained and his strong performance in role, Will Lee's salary will increase by around 20% to £670,000 with effect from 1 July 2021.

	1 July 2021 £'000	30 June 2021 £'000
Executive Directors		
Sir David McMurtry	730	715
Will Lee	670	562
Allen Roberts	426	418

2022 Annual Incentive Plan for Executive Directors

The Committee has agreed that the 2022 metrics for the Annual Incentive Plan should continue to be predominantly financial and based on Adjusted profit before tax, worth 90%, with strategic drivers worth 10%. Strategic drivers for 2022 will include: disruptive innovation; successful introduction of new products; strong capital disciplines; and embedding of the vision, values and strategy messages. Objectives have been finalised and are in the process of being cascaded worldwide, together with a stronger performance management approach which will be reinforced by reward.

No changes are proposed to the Executive Director Annual Incentive Plan for 2022.

Non-executive remuneration

John Deer, as Deputy Non-executive Chair, agreed to waive his fees for 2021, a decision the Board accepted.

A committee appointed by the Executive Directors and the Executive Chairman have reviewed the fees for the Non-executive Directors. The fees payable for each Non-executive Director for 2022 will increase to £70,000, effective as of 1 July 2021. This increase positions the total fees around the lower end of the market.

Please see page 85 for further information regarding this fee increase. No additional fees are paid for chairing Board committees.

Remuneration advisers

During the year, the Remuneration Committee put the provision of advice out to tender. After a competitive process, we appointed Deloitte to the role of adviser to the Committee and they took up the role in March 2021. The Committee is clear that Deloitte's advice is objective and independent.

Staff engagement

As disclosed on page 48, we use various methods to engage with the wider workforce, including:

- my role as employee engagement ambassador;
- my attendance at virtual meetings with employee groups; and
- regular briefings to the Remuneration Committee on pay and employment conditions of our employees.

As the restrictions lift, it is the intention of the Non-executive Directors to resume their cycle of visits and meeting with our people in order to ensure we are fully informed on what is happening in the business.

On behalf of Renishaw, I would like to thank you for your continued support and feedback. We received 92.78% approval for our policy vote last year and 97.87% for the Remuneration Report. As always, I am happy to answer questions or receive feedback.

Catherine Glickman

Chair of the Remuneration Committee

21 October 2021

Directors' Remuneration Report continued

Committee members, advisers and meetings

What does the Committee do?

The Committee helps attract, retain and motivate talented executives by ensuring competitive remuneration and motivating incentives. These incentives are linked to the overall performance of the Group and, in turn, the interests of all shareholders.

The Remuneration Committee is responsible for:

- deciding our framework for executive remuneration;
- determining the remuneration for each of the Executive Directors and other senior management;
- ensuring that suitable financial and non-financial objectives are in place to reward and encourage strong performance; and
- overseeing and reviewing the structure and operation of the remuneration policy.

The terms of reference for the Committee are published on our website www.renishaw.com/corporategovernance.

Members

All members of the Committee are Independent Non-executive Directors: Catherine Glickman (Chair), Sir David Grant, Carol Chesney and John Jeans. The Committee met eight times in this financial year, which included three unscheduled meetings (noted below), and we set out below a summary of the topics discussed in those meetings.

The General Counsel & Company Secretary acts as Secretary to the Committee. Executive Directors may attend meetings of the Committee by invitation (to advise on the remuneration and performance of senior management and to take part in specific discussions), although they are not present for any discussions that directly relate to their own remuneration.

Advisers

Independent advisers are used as needed and our current advisers are Deloitte, having been appointed following a competitive tender process which concluded in March 2021. For the period from July 2020 to March 2021 our advisers were Mercer Kepler.

The Committee approved the recommendation to appoint Deloitte as the new remuneration advisers and all bidders were notified in writing of the outcome of the process at the beginning of March 2021.

Both Mercer Kepler and Deloitte are founder members of the Remuneration Consultants Group and, as such, voluntarily operate under the code of conduct in relation to executive remuneration consulting in the UK. The Committee believes that the advice received from Mercer Kepler and Deloitte is objective and independent.

Total professional fees and expenses paid to Mercer Kepler for advice received was £11,500.

Total professional fees and expenses paid to Deloitte for advice received from 26 March 2021 until the end of this financial year was £7,600.

Both Mercer Kepler and Deloitte were appointed by the Committee and have not advised us on any other matters.

During the period in which Mercer Kepler were appointed, the actuarial advisory division of Mercer Limited (Mercer Kepler's parent company) provided advice to the trustees of the Company's UK defined benefit pension scheme and in relation to the defined contribution scheme. This work is entirely separate from the work undertaken by Mercer Kepler for the Committee.

Committee members	Attended scheduled meetings	Attended unscheduled meetings
Catherine Glickman (Chair)	5/5	3/3
Sir David Grant	5/5	3/3
Carol Chesney	5/5	3/3
John Jeans	5/5	3/3

Meetings

Date	Topic
6 July 2020	– Annual Report
28 July	– Remuneration policy review; Annual Report; Committee meeting schedule for 2021
21 October*	– Executive Directors' Annual Incentive Opportunity – financial and non-financial objectives; remuneration adviser review
26 November*	– Organisational changes – structure, remuneration and service contracts
22 February 2021*	– Remuneration adviser – tender process outline and recommendation; review of financial and non-financial objectives for Executive Directors' bonus plan 2021
22 March	– Executive Directors' and senior management bonus plan; Executive Directors' and senior management salary review; remuneration adviser – update on new appointment
10 May	– Bonus proposal for 2021; financial and non-financial objectives for 2022; senior management reward options
22 June	– Employee bonus and salary award for 2021; Remuneration Committee evaluation 2021; Executive Directors' salary proposal and 2021 bonus; financial and non-financial objectives for 2022 Executive Directors' bonus plan

* Unscheduled meeting

Remuneration at a glance

Executive Director remuneration in 2021 vs 2020

The graph shows a comparison of the Executive Directors' total remuneration (including a breakdown of the components) for the financial years ending 2021 and 2020.

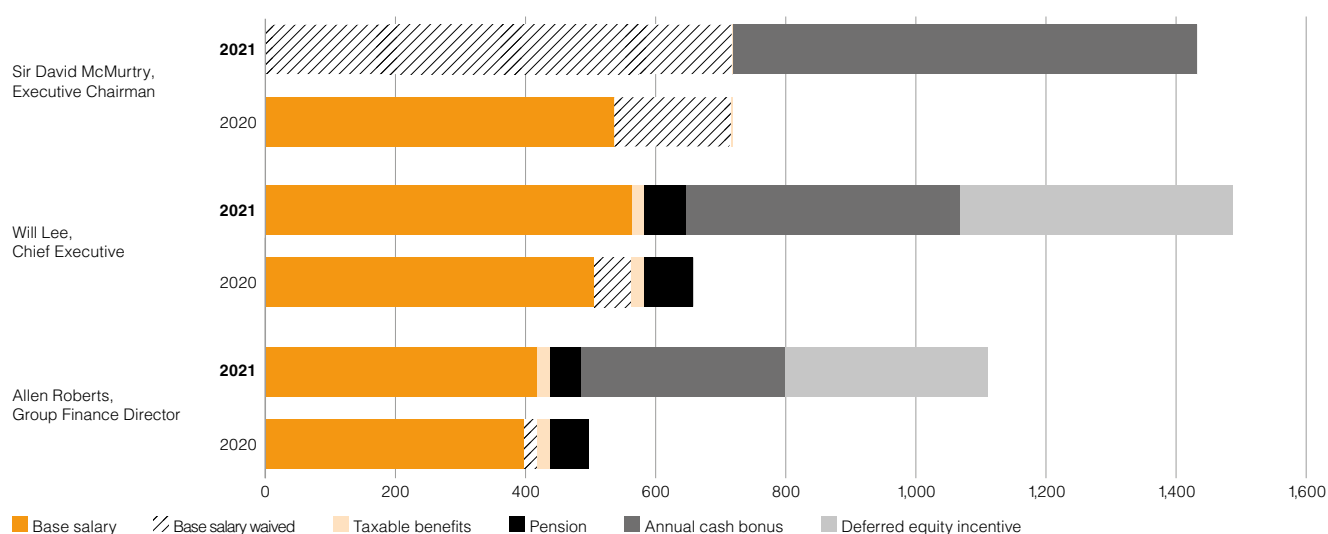

Executive Directors: share ownership

The remuneration policy approved by the shareholders at the AGM in 2020 includes a minimum shareholding guideline for Executive Directors only. Current shareholdings for comparison with the shareholding requirements are calculated based on annualised salary as at 30 June 2021 and by reference to the closing share price on 30 June 2021 (4,926p).

	Current Executive Directors		
	Sir David McMurtry	Will Lee	Allen Roberts
Number of ordinary shares of 20p each beneficially owned as at 30 June 2021	26,377,291	3,700	5,165
Actual (× salary)	1,818	0.325*	0.609
Requirement (× salary)	0.5	2.0	0.5

* Will Lee is in the process of building towards his minimum shareholding guideline, and has increased his proportionate shareholding since 2020.

Total shareholder return (TSR)

Alignment of Executive Director and shareholder interests is reinforced by the significant shareholding of our Executive Chairman, and for non-founder Executive Directors through deferred annual equity plan awards being denominated in shares.

To demonstrate alignment of performance alongside shareholder interests, the chart below shows our strong TSR performance over the last 10 years, illustrating we have outperformed the FTSE 250 index consistently over the last five years.

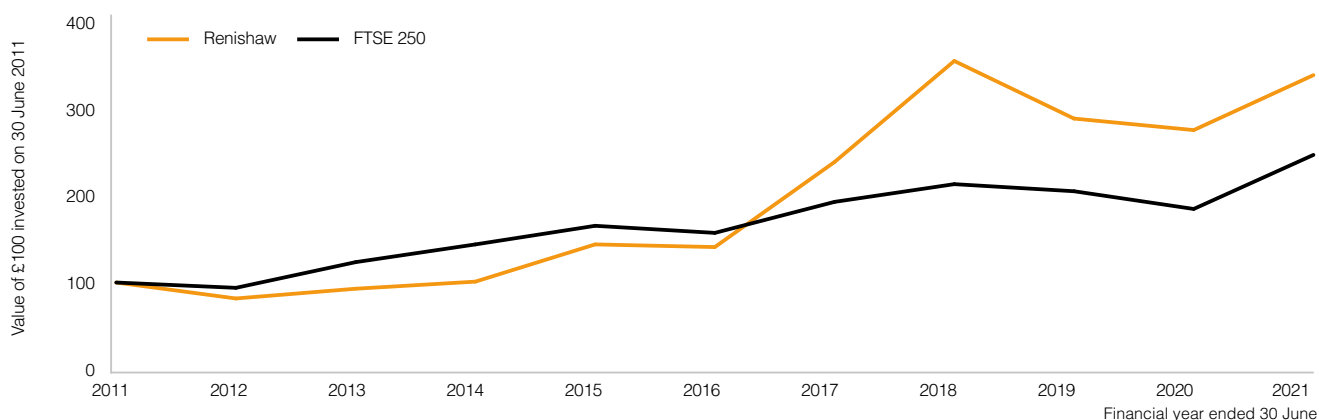

Remuneration at a glance continued

Annual incentive opportunity

The Committee sets Group performance targets, including a threshold below which no annual incentive is earned, increasing from zero on a straight-line basis to a target at which 75% of salary (equivalent to 50% of the maximum opportunity for non-founder Executive Directors) would be earned, and to a cap at which the maximum opportunity of 150% of salary could be earned. The targets for payouts of between 100% of salary ('Stretch') to 150% of salary ('Maximum') will incentivise and reward even greater outperformance of profit growth expectations for any year.

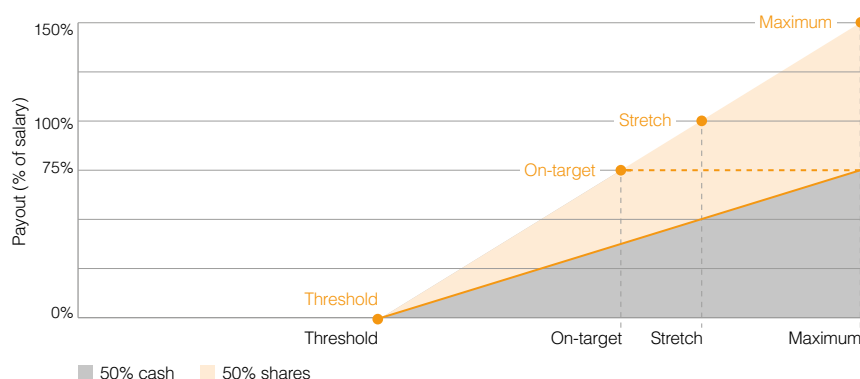

Sir David McMurtry participates in the annual bonus plan: his incentive opportunity is capped at a maximum of 100% of salary, to be paid in cash.

How is performance reflected in our incentives?

Adjusted* profit before tax is a key measure of Renishaw's financial performance.

In the financial year 2020/2021, Adjusted PBT was weighted 90% in the annual incentive opportunity, with the remaining 10% subject to the achievement of non-financial objectives including to:

- accelerate key new product development;
- target investment to deliver maximum return; and
- drive productivity and accountability through the organisational restructure and cultural alignment.

The Adjusted PBT targets for 2021 were: threshold £73m; on-target £88m; and maximum £103m.

* Note 28 (Alternative performance measures) defines how Adjusted PBT is calculated.

KPI – performance snapshot

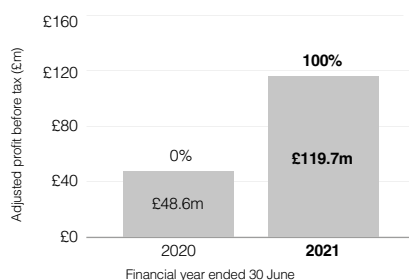

Adjusted profit before tax*

The percentages in this bar chart refer to the total of the maximum awards that could be made to the Executive Directors. In the year ended 30 June 2020 no awards were made as the financial targets were not met, and in the year ended 30 June 2021 the Executive Directors received the maximum bonus available under our annual incentive opportunity as both the financial and non-financial objectives were met.

Our financial performance for the year ended 30 June 2021 has resulted in the following awards:

Executive Director	Cash bonus £'000	Deferred into shares £'000	Total £'000
Sir David McMurtry	715	n/a	715
Will Lee	421	421	842
Allen Roberts	313	313	626

Directors' remuneration policy

The remuneration policy approved at the 2020 AGM underpins the implementation of our strategic objectives. A summary of the key elements can be found below, and the full policy is available at www.renishaw.com/en/21987.aspx

Remuneration principles – total remuneration policy

Delivering the strategy To attract, motivate and retain talented Executive Directors to support the delivery of Renishaw's strategy and maximise long-term shareholder value	Simple and aligned Executive Director remuneration is designed to be simple, conservative and aligned with shareholder interests	Proportionate A cap on total remuneration at the upper quartile of the relevant market for the position in question	Linked to performance Performance measures are defined for each constituent element of remuneration
--	--	---	---

Base salary

Policy

- Renishaw aims to pay base salaries between median and upper quartile, reflecting that its variable pay opportunities remain significantly below market.
- Maximum: upper quartile of the relevant market.
- Measured by: continued good performance.

Link to strategy

To provide a competitive remuneration package to motivate and retain Executive Directors of the required calibre to help the Group deliver its strategic objectives.

Benefits

Policy

- Benefits provided on an ongoing basis include: a car or car allowance; private medical insurance; and long-term disability cover. We may provide new Executive Directors with reasonable and proportionate support if they need to move closer to their place of work.
- Maximum: capped at £50,000 a year (excluding accommodation and relocation costs).
- Measured by: not applicable.

Link to strategy

To provide market-competitive benefits to motivate and retain Executive Directors and to support them to give maximum attention to their role.

Pension

Policy

- To provide a pension contribution/allowance in line with the wider workforce of the home country of the Executive Director and to motivate and retain Executive Directors of the required quality to meet the Group's objectives.
- As from 1 August 2020, Executive Directors who joined Renishaw prior to 2007 will receive pension contributions into our UK defined contribution scheme, or all or part as an allowance paid in lieu, at 11% of salary, in alignment with other long-serving employees. Executive Directors who joined Renishaw after 2007 will receive the same annual contributions as other more recent joiners in the wider workforce (currently 9% of salary).
- The allowance will be made into our defined contribution scheme or all or part as a cash allowance in lieu, as agreed by the Committee.
- Maximum: 11% of base salary for Executive Directors who joined Renishaw prior to 2007 and 9% of base salary for those who joined after 2007.
- Measured by: not applicable.

Link to strategy

To provide a pension contribution/allowance in line with the wider workforce of the home country of the Executive Director and to motivate and retain Executive Directors of the required quality to meet the Group's objectives.

Directors' remuneration policy continued

Annual incentive opportunity (cash bonus and deferred equity awards)

Policy

- The Committee sets Group performance targets, including a threshold below which no annual incentive is earned, increasing from zero on a straight-line basis to a target at which 75% of salary (equivalent to 50% of the maximum opportunity for non-founder Executive Directors) would be earned to a cap at which the maximum opportunity of 150% of salary could be earned.
- Part or all of any annual incentive payment (whether paid in cash or deferred into shares) may be subject to repayment in the event of any: material financial misstatement; error in calculation; misconduct; corporate failure; material loss; and/or reputational damage.
- Maximum: 150% of salary for non-founder Executive Directors and 100% of salary for Sir David McMurtry (the award for whom is paid in cash only).
- Measured by: primarily by Adjusted PBT, together with financial and non-financial metrics. Any non-financial metrics shall not form more than 25% of the overall bonus opportunity.

Link to strategy

To incentivise and reward the execution of the Group's objectives, reward outperformance and encourage Executive Director share ownership.

Minimum shareholding

Policy

- Chief Executive is expected to build up and maintain a level of share ownership of at least 200% of base salary.
- All other Executive Directors are expected to build up and maintain a level of share ownership of at least 50% of base salary. Any future Executive Director appointments will be required to build up and maintain a level of share ownership of at least 200% of base salary.
- 50% of any net vested share awards (after disposals to meet tax liabilities) must be retained until the minimum shareholding guideline is met.
- The required level of shareholding is expected to be achieved within five years of an Executive Director's appointment.
- Maximum: not applicable.
- Measured by: not applicable.

Link to strategy

Supports the alignment of Executive Director and shareholder interests.

Post-employment shareholding

Policy

- Executive Directors (excluding Sir David McMurtry) will be required to maintain a personal shareholding in Renishaw plc at a level of at least the lower of their actual shareholding and the level of their minimum shareholding guideline for one year after they step down from the Board, and 50% of that level for a further year.
- This applies to shares awarded after October 2020.
- The Committee retains the discretion to modify the post-employment shareholding requirement in certain exceptional circumstances; for example, on a change of control or if a conflict of interest arises with an Executive Director's next appointment.
- Maximum: not applicable.
- Measured by: not applicable.

Link to strategy

Supports the principle of long-term share ownership that is promoted by the 2018 UK Corporate Governance Code.

Non-executive Directors' policy table

The remuneration of the Non-executive Directors is determined by the Executive Directors and consists of a board fee only. There is no entitlement to any additional fees nor any bonus, incentive plans or pension. There are no additional fees payable as each Non-executive Director contributes in their own way, according to their unique skillset and experience. Set out below is a table summarising the approach to fees for the Non-executive Directors of the Company.

The Non-executive Directors are appointed for an initial three-year period subject to annual performance review and re-elections at AGMs, unless terminated earlier by either party on one month's written notice. Appointments will not normally continue beyond nine years in office, although there may be exceptions where a certain skillset is difficult to replace and/or in order to allow a comprehensive recruitment exercise to be conducted.

Board fees

Operation

- All Non-executive Directors are paid the same fee, irrespective of membership of, or their chairing of, Board committees.
- The fees are reviewed annually with reference to fees payable to non-executive directors of companies of a similar size and complexity.
- Reasonable expenses that are incurred by Directors in undertaking their duties as a director are reimbursed.
- Performance measures are not applicable.

Maximum

- The maximum aggregate Non-executive Director fees payable are set by the Company's Articles of Association, currently an aggregate of £500,000 per year¹.

Link to strategy

To provide a competitive fee to attract and retain Non-executive Directors of the required calibre to meet the Group's objectives.

¹ As approved by way of a separate ordinary resolution at the 2020 AGM, the maximum aggregate fees under the Company's Articles of Association for all Non-executive Directors were increased from £300,000 to £500,000 per annum to ensure that any future annual increases, in the ordinary course, can be made and to allow for the appointment of additional Non-executive Directors. As referred to on page 79, the Non-executive Directors fees will be increased from £56,155 to £70,000 for 2022, effective from 1 July 2021.

Directors' remuneration policy continued

The Committee has considered the remuneration policy and practices in the context of the principles of the UK Corporate Governance Code, particularly provisions 40 and 41, as follows:

Principle	How we have applied the principle
Clarity	The Committee engages with executives, shareholders and employees in order to explain the approach to executive pay. For example, following feedback from shareholders in September 2020 regarding proposed changes to the Directors' remuneration policy, the Committee agreed to make some changes to further clarify two issues: the minimum in-post shareholding requirement for future Executive Director appointments would be 200% of salary (same as for the current Chief Executive); and the maximum award opportunity under any long-term incentive for a new Executive Director during the current policy (three years), would be 200% of salary.
Simplicity	The purpose, structure and strategic alignment of each element of pay has been clearly laid out in the remuneration policy.
Risk	There is an appropriate mix of fixed and variable pay, and financial and non-financial objectives, and there are robust measures in place to ensure alignment with long-term shareholder interests, including the post-vesting retention period, minimum shareholding requirement and bonus deferral into shares.
Predictability	The pay opportunities under different performance scenarios (threshold, on target, stretch and maximum) are set out on page 84 of this report.
Proportionality	Executives are incentivised to achieve annual stretching targets, and the Committee assesses performance holistically at the end of the period, taking into account performance against the financial and non-financial objectives. There is no payout if the financial objectives are not met. The Committee may exercise discretion to ensure that payouts are appropriate.
Alignment with culture	One of the non-financial objectives for this financial year was to drive productivity and accountability (following the organisational restructure in the previous financial year), as well as cultural alignment. This objective is directly linked to the culture of the organisation.

Executive Director service contracts

The Executive Directors' service contracts require 12 months' notice of termination by either party. There are no obligations in any Executive Director's service contract, or Non-executive Director's letter of appointment, which would require the Company to pay a specific amount of compensation for loss of office.

The Executive Directors' service contracts reflect our policy regarding notice periods. No payment will be made for a termination by the Company for a breach by the Executive Director of his or her service contract. In other cases, payment in lieu of notice will be considered up to the 12 months' notice period to cover base salary, benefits and pension contributions. If additional compensation must be considered, such as on a settlement agreement, the Committee will consider all relevant commercial factors affecting the specific case. Directors' service contracts are available for inspection at our registered office upon written request to the Company Secretary.

Executive Director	Date of current service contract
Sir David McMurtry	18 October 2018
Will Lee	1 June 2020
Allen Roberts*	20 April 2021

Non-executive Director letters of appointment

Non-Executive Director	Date of letter of appointment
John Deer	3 February 2020
Carol Chesney	4 October 2012
Catherine Glickman	20 July 2018
Sir David Grant	13 April 2012
John Jeans	8 April 2013

* From 1 July 2020 to 19 April 2021, Allen Roberts was party to a service contract dated 20 June 2006, as amended on 27 July 2017.

Approach to remuneration and consideration of stakeholders

Consideration of stakeholders

We consider a variety of stakeholder views when determining executive pay, including those of our shareholders, colleagues, and external bodies. See pages 46–54 for more information on how we consider our stakeholders' views.

Employee engagement

The Remuneration Committee is supportive of the growing focus on engaging the employee voice, which has accompanied recent changes to the UK Corporate Governance Code. The Chair of the Committee is the ambassador for our workforce engagement activities and has attended virtual meetings with HR and employee groups which has been useful for gaining an insight into employee views on a range of subjects. With restrictions in the UK easing, we intend to restart direct engagement for the Non-executive Directors via onsite visits in the year ending 30 June 2022.

Statement of consideration of employment conditions elsewhere in the Group

When reviewing and determining the Director's remuneration policy, the Remuneration Committee is briefed on pay and employment conditions of employees in Renishaw as a whole, with particular reference to the UK, being the market in which the Executive Directors are based. The Chief Executive pay ratio is on page 91. The Remuneration Committee is satisfied that the approach taken is fair and reasonable based on market conditions and practice, and the best interests of shareholders.

We do not specifically consult with employees on our Executive Director remuneration policy.

Gender pay gap

We have a mean gender pay gap in the UK of 23.7%. In recognition of the need to reduce our gender pay gap, we are establishing a working group with the principal objective of creating a better understanding of, and reducing, Renishaw's pay gap.

Employee pay and benefits

Due to global economic uncertainties at the start of the pandemic, we did not make base pay increases for the year ended 30 June 2021. However, in January 2021, we made a payment of £750 to each employee to thank them for their dedication and commitment during this challenging time. In addition, we provided full pay to those employees who were unable to work due to COVID-19 shielding or self-isolation requirements.

To reward and recognise the strong performance achieved in this financial year, eligible employees received an annual bonus paying out a UK minimum of £1,000 increasing to a maximum of 75%. Base pay increases in line with local markets were also awarded effective from 1 July 2021, including 2.1% in the UK.

We offer benefits to promote a good standard of living for employees. These vary by site but may include subsidised canteens, contributory pensions, life insurance and enhanced parental pay.

Renishaw is also in the process of adopting a hybrid working model to reflect changing working practices and promote a healthy work-life balance.

Gender pay gap

23.7%
mean

23.2%
median

2020 UK average (median) pay gap 15.5%

Gender bonus gap

39.1%
mean

26.8%
median

83.9% of women received bonus pay
84.3% of men received bonus pay

Statement of consideration of shareholder views

The Committee considered shareholder feedback when drawing up the current remuneration policy. We consulted the top 20 external shareholders as well as proxy voting agencies in May and June 2020 regarding the proposed changes. The Committee is grateful for feedback from shareholders as part of this process, which indicated broad support for the initial proposals. While no substantive changes were made to the policy as a result of the feedback before publication of our last Annual Report, a number of shareholders and proxy voting agencies raised questions and concerns following publication. The Remuneration Committee took into account these questions and, following further discussion, we announced the following clarifications to the proposed remuneration policy on 24 September 2020:

- minimum in-post shareholding requirement: future Executive Directors will have to build and maintain a shareholding of at least 200% of salary over time; and
- recruitment remuneration: the maximum award opportunity under any long-term incentive for a new Executive Director, for the period of the current policy (three years), being 200% of salary.

The Committee has continued to engage with external shareholders and proxy voting agencies in 2021, including in relation to the implementation of the remuneration policy regarding Executive Directors' salary increases effective as from 1 July 2021.

The Committee will also continue to monitor trends and developments in corporate governance and market practice to ensure the structure of executive remuneration remains appropriate.

Annual Report on remuneration

This section of the report sets out the remuneration of the Directors in the financial year ended 30 June 2021 and also contains details of how we intend to implement the remuneration policy for the forthcoming financial year. The information on pages 88 to 93 has been audited where required under the regulations and is indicated as audited where applicable.

This Remuneration Report has been prepared in accordance with Schedule 8 of the Large and Medium sized Companies and Groups (Accounts and Reports) (Amendment) Regulations 2008 (as amended in 2013, 2018 and 2019), LR9.8 of the Listing Rules and the UK Corporate Governance Code 2018.

Single total figure table (audited) – Executive Directors

	Salary		Benefits		Pension		Bonus ²		Total fixed remuneration		Total variable remuneration		Total remuneration	
	2021 £'000	2020 ¹ £'000	2021 £'000	2020 £'000	2021 £'000	2020 £'000	2021 £'000	2020 £'000	2021 £'000	2020 £'000	2021 £'000	2020 £'000	2021 £'000	2020 £'000
Sir David McMurtry	0 ³	536	3	3	n/a	n/a	715	0	3	539	715	0	718	539
John Deer ⁴	n/a	260	n/a	12	n/a	n/a	n/a	0	n/a	272	n/a	0	n/a	272
Will Lee	562	505	20	20	64	76	842	0	646	601	842	0	1,488	601
Allen Roberts	418	398	20	20	47	60	626	0	485	478	626	0	1,111	478

Single total figure table (audited) – Non-executive Directors

	Fees		Expenses		Total remuneration ⁷	
	2021 £'000	2020 ¹ £'000	2021 £'000	2020 £'000	2021 £'000	2020 £'000
John Deer ⁵	0 ⁶	9	1	0	1	9
Carol Chesney	56	53	0	0	56	53
Catherine Glickman	56	53	0	0	56	53
Sir David Grant	56	53	0	0	56	53
John Jeans	56	53	0	2	56	55

1 The figures for 2020 represent the impact on salary or fees received for the financial year ended 30 June 2020, as a result of the COVID-19 pandemic, as follows: Sir David McMurtry waived his salary from 1 April to 30 June; John Deer waived his fees from 6 April to 30 June; Will Lee had a 40% reduction in salary from 1 April to 30 June; Allen Roberts had a 20% reduction in salary from 6 April to 30 June; all of the independent Non-executive Directors had a 20% reduction in fees from 6 April to 30 June.

2 The value of the bonus includes both the value of the annual cash bonus and the face value of shares to be awarded under the deferred annual equity incentive in respect of the relevant financial year. Deferred shares will normally vest on the third anniversary of grant, subject to continued employment.

3 Sir David McMurtry waived his salary from 1 July 2020 to 30 June 2021.

4 John Deer stepped down as an Executive Director on 29 January 2020 (becoming a Non-executive Director) and therefore these figures reflect remuneration received during the period from 1 July 2019 to 29 January 2020.

5 John Deer became a Non-executive Director on 30 January 2020 and therefore these figures reflect remuneration received during the period from 30 January 2020 to 30 June 2020.

6 John Deer waived his fee from 1 July 2020 to 30 June 2021.

7 The Non-executive Directors are not eligible for any variable remuneration and only receive fixed remuneration.

Benefits

	Car allowance £'000	Private medical cover applies to all Executive Directors and insurance on personal cars apply to some Directors £'000
Sir David McMurtry	0	3
Will Lee	20	0
Allen Roberts	20	0

Incentive outcomes for the year ended 30 June 2021

Under the remuneration policy approved at the 2020 AGM, the Executive Directors were eligible in the year ended 30 June 2021 for an annual incentive opportunity (as set out on page 89).

The incentive opportunity is based on financial and non-financial metrics, although the award is only payable provided the financial metrics are met (irrespective of performance against the non-financial metrics). The Committee established stretching targets for both the financial and non-financial elements of the award.

The financial metrics comprise 90% of the award and are primarily based on Adjusted PBT and the non-financial or strategic metrics comprise the remaining 10% of the award. The targets and achievement against these targets are set out in the table below and illustrated in the graph on page 90. The Committee considers that the level of pay-out is reflective of the overall performance of the Group in the year and is appropriate.

	Threshold	On-target	Maximum	Actual
Adjusted PBT (£m)	£73m	£88m	£103m	£119.7m
% of bonus payable for Adjusted PBT performance	0%	45%	90%	90%

The non-financial or strategic metrics comprise the remaining 10% of the award and for the financial year ended 30 June 2021 included to:

- accelerate key new product development;
- target investment to deliver maximum return; and
- drive productivity and accountability following last year's organisational restructure and cultural alignment.

The Adjusted PBT for the financial year ended 30 June 2021 was £119.7m. This result exceeds the maximum threshold target set by the Committee.

All of the strategic or non-financial targets were also satisfied as shown in the table below:

Non-financial objective	Outcome of objective	% of bonus payable for meeting strategic targets	% of bonus actually paid out
Accelerate key new product development	A focused effort on reducing the number of active projects to allow increased resourcing of key product development projects. For example: <ul style="list-style-type: none"> – the machine tool product line introduced the second-generation NC4+ Blue non-contact tool setting system, with ultra-compact design and measurement repeatability down to ± 0.5 microns; and – within the position encoder line, a significant addition was the FORTIS enclosed linear absolute encoder for harsh environments, including machine tools. It has also accelerated the pipeline of significant new products which are currently under development and are critical to the future growth plans of the business.		
Target investment to deliver maximum return	Targeted investment decisions being made in key strategic areas, such as: <ul style="list-style-type: none"> – in R&D to deliver products with unparalleled levels of precision, productivity and practicality; – in the global marketing and distribution infrastructure; and – in-house manufacturing to improve control over quality, delivery and costs. 	10%	10%
Drive productivity and accountability through the organisational restructure and cultural alignment	Accountability and productivity has been increased through: <ul style="list-style-type: none"> – decentralisation of decision making with clearer delegated responsibilities; – improvement of reporting against objectives; – improved allocation of key resources to flagship projects; – the appointment of a new Group Operations Director; and – the roll out of the revised vision and strategy. 		

Incentive opportunity outcome

The maximum opportunity for the year ended 30 June 2021 was 150% of salary for non-founder Executive Directors and 100% of salary for Sir David McMurtry. For the non-founder Executive Directors, 50% of any bonus earned is to be deferred into shares for three years; any award to Sir David McMurtry will be made in cash.

Our financial performance for this has resulted in the following awards:

Executive Director	Cash bonus £'000	Deferred into shares £'000	Total £'000
Sir David McMurtry	715	n/a	715
Will Lee	421	421	842
Allen Roberts	313	313	626

Total pension entitlements

Will Lee is a member of our closed defined benefit scheme. The normal retirement age is 65. On death, pension benefits would pass to that member's dependents.

Since the closure of the defined benefit scheme, contributions have been made to a defined contribution scheme or paid in cash.

At 30 June 2021:	Value of defined benefit pension entitlement £'000 per year	Pension contributions
Will Lee	9	Paid in cash

Annual Report on remuneration continued

Payments to past Directors

No payments were made to past Directors during the year.

Loss of office payments

There were no loss of office payments during the year.

Performance graph

The graph below shows our TSR performance, compared with the FTSE 250 index, which the Committee believes is the most appropriate broad index for comparison, as Renishaw is a member of this index. TSR performance was rebased to 100 at 30 June 2011.

TSR performance

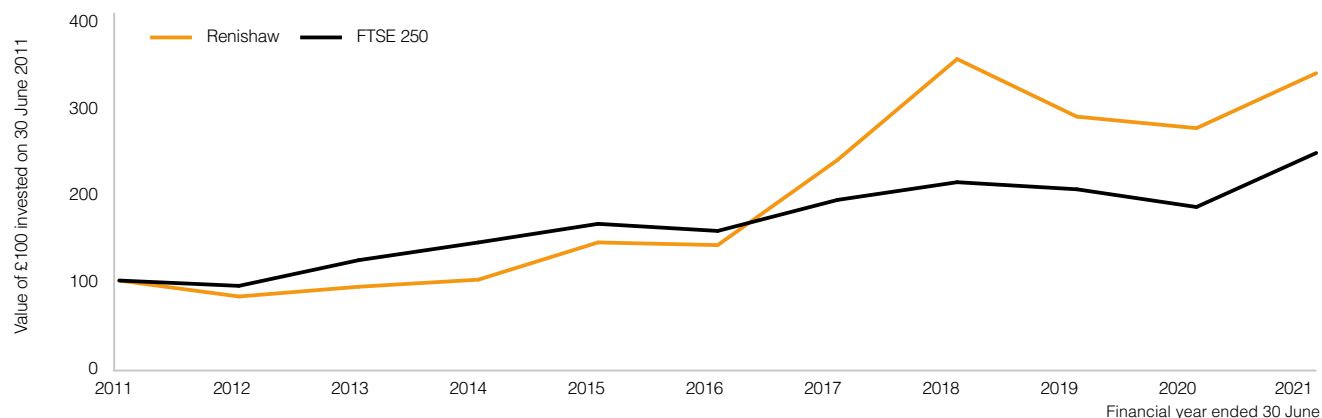

Chief Executive total remuneration

The table below sets out information relating to the remuneration of the Chief Executive for each of the years in question:

Year	2012	2013	2014	2015	2016	2017	2018	2019	2020	2021
Will Lee (from 1 February 2018)										
Single figure of total remuneration (£'000)							594	653	601	1,488
Annual bonus payout (includes annual cash bonus and deferred equity incentive) % of maximum							95	0	0	100
Long-term incentive vesting % of maximum							n/a	n/a	n/a	n/a
Sir David McMurtry (until 31 January 2018)										
Single figure of total remuneration (£'000) ¹	969	663	632	1,298	668	1,207	818			
Annual bonus payout % of maximum	69	10	0	100	0	77	100			
Long-term incentive vesting % of maximum	n/a	n/a	n/a	n/a	n/a	n/a	n/a			

¹ Represents the total remuneration received by Sir David McMurtry in relation to this role.

Chief Executive pay ratio

The table on page 91 sets out the Chief Executive pay ratios as at 30 June 2021 and 30 June 2020. The report will build up over time to show a rolling 10-year period. The ratios compare the single total figure of remuneration of the Chief Executive with the equivalent figures for the lower quartile (P25), median (P50) and upper quartile (P75) employees. Ratios are also presented using base salary only.

We have used the 'Option B' methodology (based on gender pay reporting), as the most robust way to identify the individual reference points within an organisation with multiple operating segments.

Chief Executive pay ratio

Total remuneration

2021	Employee remuneration			Pay ratio		
	P25	P50	P75	P25	P50	P75
Chief Executive						
£1,487,487	£28,438	£37,720	£45,170	52.3	39.4	32.9
2020 ¹	Employee remuneration			Pay ratio		
	P25	P50	P75	P25	P50	P75
Chief Executive						
£601,241	£27,476	£35,619	£51,563	21.9	16.9	11.6

Base salary

2021	Employee remuneration			Pay ratio		
	P25	P50	P75	P25	P50	P75
Chief Executive						
£561,500	£24,420	£32,670	£42,480	23.0	17.2	13.2
2020 ¹	Employee remuneration			Pay ratio		
	P25	P50	P75	P25	P50	P75
Chief Executive						
£505,350	£24,650	£32,634	£47,092	20.5	15.5	10.7

¹ Where necessary, adjustments were made to the underlying data to reflect a reduction in working hours during April 2020 to June 2020 in connection with the COVID-19 pandemic. The reductions in salary and employer pension contributions during this time have been added back to give a full-time equivalent figure. No other adjustments were made to the underlying data.

The base salary for the Chief Executive increased by 11% this year. This is solely due to a 40% reduction in the Chief Executive's salary in the final quarter of 2020 during the early stages of the pandemic. This salary reduction is one of the main reasons for the increase in the base salary ratios this year.

The base salary for employees at P25, P50 and P75 have also changed primarily due to a higher proportion of leavers being from the first and second quartiles. Leavers arose from both the restructuring programmes undertaken last year as well as annual attrition.

The total remuneration ratios also increased during the year. As well as the factors affecting the base salary ratios, the Chief Executive achieved the maximum bonus award this year compared with no bonus award in the prior year.

Taking into account the above, the Committee considers the median pay ratio consistent with the Company's approach to pay and reward. The Committee will continue to monitor the ratios on an annual basis.

Executive Directors serving as non-executive directors of other companies

During the year none of the Executive Directors were paid to serve as a non-executive director for any other company.

Statement of Directors' shareholding and share interests

During the year, none of the Directors were required to own shares in the Company, although the remuneration policy approved by the shareholders at the AGM in 2020 includes a minimum shareholding guideline for Executive Directors. As at 30 June 2021 the share interests (including the interests of connected persons) of the Directors who have served on the Board at any time during the year are:

	Number of ordinary shares of 20p each beneficially owned (as at 30 June 2021)	Unvested and subject to continued employment (awarded under the deferred equity incentive plan)	Minimum shareholding guideline	Current shareholding ¹	Minimum shareholding guideline met
Sir David McMurtry	26,377,291	n/a	0.5x salary	1,818x salary	Yes
Will Lee	3,700	3,537	2x salary	0.325x salary	Building
Allen Roberts	5,165	3,051	0.5x salary	0.609x salary	Yes
John Deer ²	12,076,790	n/a	n/a	n/a	n/a
Carol Chesney	1,000	n/a	n/a	n/a	n/a
Catherine Glickman	675	n/a	n/a	n/a	n/a
Sir David Grant	–	n/a	n/a	n/a	n/a
John Jeans	440	n/a	n/a	n/a	n/a

¹ Current shareholdings for comparison with the shareholding requirements for Executive Directors are calculated based on annualised salary as at 30 June 2021 and by reference to the closing share price on 30 June 2021 (4,926p).

² John Deer stepped down as an Executive Director on 29 January 2020 (becoming a Non-executive Director) and therefore is no longer subject to the minimum shareholding guideline. For the avoidance of doubt, while John Deer was an Executive Director his shareholding exceeded the share ownership guideline that applied in that tenure (i.e. during the period from 1 July 2019 to 29 January 2020).

Deferred equity incentive plan awards granted during the year

There were no share-based payments made during the year. Will Lee and Allen Roberts were eligible to receive an award under the deferred equity incentive plan for performance over the year under review. The details of these awards – which at the date of this Directors' Remuneration Report have yet to be granted – will be reflected in the above table in next year's Remuneration Report.

Annual Report on remuneration continued

Percentage change in remuneration of the Directors

The following table sets out the percentage change in the Directors' remuneration compared with the percentage change in average remuneration to UK employees in 2020 and 2021. The figures shown in the table below refer to the base salary actually received by each Director, therefore these figures do not include the fees (whether all or part) which were waived by each Director for either or both financial years.

Sir David McMurtry	Salary	Benefits	Annual bonus
2020 £'000	536	3	0
2021 £'000	0 ¹	3	715
% change	n/a	0	n/a
John Deer	Salary	Benefits	Annual bonus
2020 £'000	270 ²	12	0
2021 £'000	0 ³	1	n/a
% change	n/a	-94	n/a
Will Lee	Salary	Benefits	Annual bonus
2020 £'000	505	20	0
2021 £'000	562	20	842
% change	11	0	n/a
Allen Roberts	Salary	Benefits	Annual bonus
2020 £'000	398	20	0
2021 £'000	418	20	626
% change	5	0	n/a

Carol Chesney	Fees	Expenses	Annual bonus
2020 £'000	53	0	n/a
2021 £'000	56	0	n/a
% change	5	0	n/a

Catherine Glickman	Fees	Expenses	Annual bonus
2020 £'000	53	0	n/a
2021 £'000	56	0	n/a
% change	5	0	n/a

Sir David Grant	Fees	Expenses	Annual bonus
2020 £'000	53	0	n/a
2021 £'000	56	0	n/a
% change	5	0	n/a

John Jeans	Fees	Expenses	Annual bonus
2020 £'000	53	2	n/a
2021 £'000	56	0	n/a
% change	5	n/a	n/a

UK employee (average)	Salary	Benefits	Annual bonus
% change	0.9%	0.9%	n/a

1 Sir David McMurtry waived his salary from 1 July 2020 to 30 June 2021.

2 John Deer stepped down as an Executive Director on 29 January 2020 (becoming a Non-executive Director) and therefore this figure was calculated on the basis of the salary received as Executive Director during the period from 1 July 2019 to 29 January 2020 and the fees received as Non-executive Director during the period from 30 January 2020 to 30 June 2020.

3 John Deer waived his fee from 1 July 2020 to 30 June 2021.

Relative importance of spend on pay

The following table sets out the total amount spent in the current financial year and the previous financial year on remuneration to all Group employees and on dividends to shareholders:

	2021 £'000	2020 £'000	Change %
Employee remuneration	224,760	225,641	-0.39
Shareholder dividends paid	10,189	33,478	-69.6

Except as shown above, no other distributions have been made to shareholders or other payments or uses of profit or cash flow that affect the understanding of the relative importance of spend on pay.

Statement of implementation of remuneration policy in the next year

Base salary

The Committee determined that the salaries for each of the Executive Directors will increase as of 1 July 2021. Further information, including the salaries for 2022 and the rationale behind the increases, is set out in the Chair's statement on page 77.

Annual cash bonus and deferred annual equity incentive

As set out in the remuneration policy approved at the 2020 AGM, the annual cash bonus and deferred annual equity incentive have been combined into a single award opportunity. The maximum opportunity for the year ending 30 June 2022 will be 150% of salary for non-founder Executive Directors and 100% of salary for Sir David McMurtry. For the non-founder Executive Directors, 50% of any bonus earned will be deferred into shares for three years; any award to Sir David McMurtry will be made in cash. Measures will continue to be Adjusted profit before tax and non-financial strategic objectives, with targets set by the Committee in line with our stated policy. Further details (including the targets) will be disclosed in next year's Remuneration Report.

Pension and benefits

No changes will be made to the implementation of the pension and benefits elements of the remuneration policy approved at the 2020 AGM.

Non-executive Directors

The fees payable for each Non-executive Director for the year ending 30 June 2022 will increase to £70,000. This increase was approved by the Executive Directors in June 2021 following assistance from our remuneration advisers, Deloitte, who provided the relevant benchmark reference points which indicated that the fees being paid were below the lower end when compared to the bottom 50 FTSE 100 and top 50 FTSE 250 companies. The increase in fees was the first since 2019, which had been a CPI only increase. The increase was considered to be appropriate given the substantial support provided by all of the Non-executive Directors during the FSP process, and the need to ensure that the Company continues to attract high calibre Non-executive Directors with the appropriate skills and experience. No additional fees are paid, for example, for chairing Board committees.

Consideration by Directors of matters relating to Directors' remuneration

During the year, the Remuneration Committee considered the amount of the Executive Directors' salary and the framework for the annual bonus. The members of the Committee for this purpose were:

- Catherine Glickman
- Carol Chesney
- Sir David Grant
- John Jeans

Deloitte assisted the Committee in reviewing and benchmarking the Executive Director remuneration arrangements, as well as providing other remuneration-related advice to the Committee during the year under review. Further information is set out on page 78.

Statement of voting at general meeting

At the AGM held on 30 September 2020, votes cast in respect of the Directors' remuneration policy were as follows:

Resolution	Votes for	% for	Votes against	% against	Total votes cast	Votes withheld
Approval of remuneration policy	59,462,931	92.78	4,627,677	7.22	64,090,608	894,466

At the AGM held on 30 September 2020, votes cast in respect of the Directors' Remuneration Report were as follows:

Resolution	Votes for	% for	Votes against	% against	Total votes cast	Votes withheld
Approval of Remuneration Report	63,588,672	97.87	1,382,462	2.13	64,971,134	13,940

This report was approved by the Board and has been signed on its behalf by:

Catherine Glickman

Chair of the Remuneration Committee

21 October 2021

Other statutory and regulatory disclosures

Review of the business

A review of the business and likely future developments is given in the Chairman's statement, the Chief Executive's review and the other sections of the Strategic Report. Segmental information by geographical market is given in note 2 to the Financial statements.

Our principal activities are the design, manufacture, sale, distribution and service of manufacturing technologies products and services, and analytical instruments and medical devices, as outlined on page 2 of the Strategic Report. We have established and acquired overseas manufacturing, marketing and distribution subsidiaries to manufacture some of the Group's products and support customers in the following major markets outside the UK:

- **Americas:** Brazil, Canada, Mexico and USA;
- **APAC:** Australia, China, Hong Kong, India, Japan, Malaysia, Singapore, South Korea and Taiwan; and
- **EMEA:** Austria, Czech Republic, Denmark, Finland, France, Germany, Hungary, Ireland, Israel, Italy, Netherlands, Poland, Romania, Russia, Spain, Sweden, Switzerland and Turkey.

We also have representative offices in Indonesia, Slovakia, Thailand and Vietnam.

In addition, we have a joint venture in Slovenia, RLS Merilna tehnika d.o.o. (RLS) and a subsidiary in Slovenia which designs and arranges the procurement of application-specific integrated circuits for the Group.

Further information is available on the Company's website: www.renishaw.com.

Research and development

We continue to invest significantly in developing future technologies, with R&D activities located primarily in the UK. The technologies we develop provide patented products and methods to help deliver our segmental strategies. Further information on R&D expenditure is contained in note 4 on page 122. The amount of R&D expenditure capitalised, the amount amortised, and impairment charges in the year, are given in note 12 on page 127.

Dividends

The Directors propose a final dividend of £37,850,042 or 52.0p per share which, together with the interim dividend of £10,190,396 or 14.0p per share, gives a total dividend for the year of £48,040,438 or 66.0p net per share. In comparison, last year the Board decided to cancel the interim dividend and not propose a final dividend for the year ending 30 June 2020 to help preserve cash in response to the ongoing macroeconomic uncertainty. We were pleased to reinstate the interim and final dividends as our trading conditions improved and support received from the UK furlough scheme since 1 July 2021 was repaid.

As at 30 June 2021, 9,639 shares were held by the Renishaw plc Employee Benefit Trust (EBT). The shares held by the EBT may be used to satisfy awards made to employees under the Company's employee share plan, namely the Renishaw Deferred Annual Equity Incentive Plan (DAEIP). The terms of the EBT provide that any dividends payable on the shares held by the EBT are waived. On 2 August 2021 all shares held by the EBT were sold to satisfy a vesting of awards granted under the Company's DAEIP.

Directors and their interests

The Directors at the end of the year are listed on pages 60 and 61. In accordance with the provisions of the Governance Code all Directors will retire and, being eligible, offer themselves for re-election at the AGM to be held on 24 November 2021. Details of Directors who offer themselves up for re-election are shown on pages 60–61 and full biographical details are available at www.renishaw.com.

The rules on appointment, reappointment and retirement by rotation of the Directors and their powers are set out in the Company's Articles of Association. There are no powers given to the Directors that are regarded as unusual.

We have listed the Directors' interests in the share capital of the Company (with the equivalent number of voting rights), as notified to the Company, on page 91. There has been no change in the holdings shown on page 91 in the period 1 July 2021 to 21 October 2021, other than a vesting of awards granted under the Company's DAEIP on 2 August 2021 which resulted in Will Lee receiving 1,871 shares and Allen Roberts receiving 1,675 shares after having sold shares to cover tax liabilities.

All the interests were beneficially held with the exception of 2,278,161 shares (2020: 2,368,061 shares) which were non-beneficially held by John Deer but in respect of which he has voting rights.

Sir David McMurtry, as one party, and John Deer and Mrs M E Deer, as the other party, have entered into an agreement relating to the way each party would vote in respect of his or her shares if requested by the other party to do so. Under this agreement Sir David McMurtry, John Deer and Mrs M E Deer agree that: (i) John Deer and Mrs M E Deer will vote their shares in favour of any ordinary resolution if requested to do so by Sir David McMurtry; and (ii) Sir David McMurtry will vote his shares against any special or extraordinary resolution if requested to do so by John Deer. The voting arrangement was renewed in 2018 for a further period of five years and will terminate on the earlier of 25 May 2023 or the deaths of both Sir David McMurtry and John Deer.

Directors' and officers' indemnity insurance and Directors' indemnities

Subject to the provisions of the Companies Act 2006, the Company's Articles of Association provide for the Directors and officers of the Company to be appropriately indemnified. In accordance with our Articles of Association and to the extent permitted by law, Directors (excluding the founders) were this year granted an indemnity from the Company in respect of loss and liability incurred as a result of their office. Neither our indemnity nor the insurance (referred to below) provides cover in the event that a Director is proven to have acted dishonestly, fraudulently or negligently. Copies of all indemnities granted are available for inspection at the Company's registered office.

The Company also maintains insurance for its Directors and officers in respect of their acts and omissions during the performance of their duties.

Responsibility statement

As required under the Financial Conduct Authority's Disclosure Guidance and Transparency Rules, a statement made by the Board regarding the preparation of the financial statements is set out on page 97.

Share capital and change of control

Details of the Company's share capital, including rights and obligations, is given in note 25 to the Financial statements. The Company is not a party to any significant agreements that might terminate upon a change of control of the Company.

A shareholder authority for the purchase by the Company of a maximum of 10% of its own shares was in existence during the 2021 financial year. However, the Company did not purchase any of its own shares during that time.

Auditor

A resolution to reappoint EY as the auditor of the Company will be proposed at the forthcoming AGM.

Disclosure of information to auditor

The Directors who held office at the date of approval of this statement confirm that, so far as they are each aware, there is no relevant audit information of which the Company's auditor is unaware. Each Director has taken all the steps that he or she ought to have taken as a Director to make himself/herself aware of any relevant audit information and to establish that the Company's auditor is aware of that information.

Annual General Meeting

We have set out the notice convening the AGM and an explanation of the resolutions sought in a separate circular. At the meeting, the Company will be seeking shareholder approval for, among other things, the ability to make market purchases of its own ordinary shares, up to a total of 10% of the issued share capital.

The Directors consider that all the resolutions proposed are in the best interests of the Company, and its shareholders as a whole, and unanimously recommend that shareholders vote in favour of the resolutions, as they intend to do in respect of their own holdings.

Substantial shareholdings	% of issued share capital	Number of shares
BlackRock, Inc.	4.92%	3,578,133
Capital Research and Management Company	4.76%	3,465,738
Standard Life Investments Limited	4.99%	3,631,612

On 27 August 2021 the Company received a notification from Baillie Gifford & Co that they hold 3,844,259 shares (5.28%). There have been no other changes notified to the Company, in the holdings shown above, in the period 1 July 2021 to 21 October 2021.

Substantial shareholdings

Apart from the shareholdings (and corresponding voting rights) of Sir David McMurtry and John Deer (36.23% and 16.59% respectively), the table above discloses the voting rights that have been notified to the Company under the requirements of the Financial Conduct Authority's Disclosure Guidance and Transparency Rules DTR 5, which represent 3% or more of the voting rights attached to issued shares in the Company, as at 30 June 2021. It should be noted that these holdings may have changed since being notified to the Company. However, notification of any change is not required until an applicable threshold is crossed.

Employees

The retention of our highly skilled employees is essential to the future of the business, and the Directors place great emphasis on the continuation of our training programme. Health and safety matters are given special attention by the Directors and well-established systems of safety management are in place throughout the Group to safeguard employees, customers and others.

Employment policies are designed to provide equal opportunities irrespective of race, religion, gender, age, socio-economic background, disability or sexual orientation. Full and fair consideration is given to applications for employment from people with disabilities, where suitable for appropriate vacancies. Employees who become disabled while with the Company will be given every opportunity to continue their employment through reasonable adjustment to their working conditions, equipment or, where this is not possible, retraining for other positions. They will also be afforded opportunities to continue training and gain promotion on the same basis as any of our employees.

Details on how the Directors have engaged with employees and had regard to employee interests, information provided to employees on the performance of the business, consultation with employees and performance incentives are set out in various sections of the Annual Report, including pages 79 and 87.

There are no agreements with employees providing for compensation for any loss of employment that occurs because of a takeover bid.

Suppliers, customers and other stakeholders

We have set out details on how the Directors have had regard to the need to foster the Group's business relationships with suppliers, customers and others and the effect of that regard on the principal decisions taken by the Directors during the financial year on pages 56 to 57.

Political donations

We did not make any political donations during the year.

Events after the balance sheet date

There have been no material events affecting the Company since the year end.

Financial risk management, objectives and policies

We have set out descriptions of the use of financial instruments and the Group's financial risk management objectives and policies, policies in relation to hedge accounting and exposure to market risk, including credit and liquidity risk, in note 24 to the Consolidated financial statements on page 139.

Controlling shareholders' arrangements

The Listing Rules require that premium listed companies with 'controlling shareholders' (defined as a shareholder who individually or with any of their concert parties exercises or controls 30% or more of the votes that may be cast on all, or substantially all, the matters at the Company's general meeting) must enter into a relationship agreement containing specific independence provisions.

Other statutory and regulatory disclosures continued

The independence provisions required by the Listing Rules are that:

- (i) transactions and arrangements with the controlling shareholder (and/or any of its associates) will be conducted at arm's length and on normal commercial terms;
- (ii) neither the controlling shareholder nor any of its associates will take any action that would have the effect of preventing the Company from complying with its obligations under the Listing Rules; and
- (iii) neither the controlling shareholder nor any of its associates will propose or procure the proposal of a shareholder resolution which is intended or appears to be intended to circumvent the proper application of the Listing Rules.

By virtue of his shareholding in the Company, Sir David McMurtry (Executive Chairman 36.23% shareholder) is a controlling shareholder. John Deer (Non-executive Deputy Chairman, together with his wife, 16.59% shareholder) is also a controlling shareholder by virtue of a long-standing voting agreement between John Deer (and his wife) and Sir David McMurtry. The Board confirms that the Company has not been able to enter into a relationship agreement with

its controlling shareholders, containing the independence provisions required by the Listing Rules. The FCA has been notified of this, as required by the Listing Rules. The controlling shareholders have informed the Board that they are not willing to enter into a relationship agreement because they are of the view that the requirement to enter into a relationship agreement infringes upon their rights as shareholders and their track record demonstrates that they act in the best interests of the Company.

As a result of there being no relationship agreement in place, the Listing Rules provide that certain enhanced oversight measures will apply to the Company.

This means, unless and to the extent the FCA agrees otherwise, all transactions with the controlling shareholders must be approved by the Company's shareholders (excluding the controlling shareholders) in accordance with the related party transaction requirements of the Listing Rules, and none of the normal exemptions apply.

Guidance has been received from the FCA about the application of the enhanced oversight measures to the remuneration and benefits received by the controlling shareholders in their capacity as Directors (in accordance with

the Company's approved remuneration policy) as well as other ordinary course corporate matters, such as the payment of dividends by the Company to all shareholders. The FCA has confirmed that either: (i) these are not transactions or arrangements that fall within the enhanced oversight measures; or (ii) the FCA will permit a modification of the enhanced oversight measures so they will not apply, provided the arrangements remain in the ordinary course of business and, in the case of salary reviews and bonuses, provided they fall within the small transaction exemption in the Annex to LR 11. This guidance continues to apply in respect of remuneration awarded under the existing remuneration policy (see page 83).

Greenhouse gas emissions and energy consumption

Disclosures concerning GHG emissions and energy consumption are set out on page 54.

Disclosure of information under LR 9.8.4R

The information that fulfils the reporting requirements under this rule can be found on the pages identified below.

Section	Topic	Location
(1)	Interest capitalised	Not applicable
(2)	Publication of unaudited financial information	Not applicable
(4)	Details of long-term incentive schemes	Not applicable
(5)	Waiver of emoluments by a director	Directors' Remuneration Report, starting on page 77
(6)	Waiver of future emoluments by a director	Not applicable
(7)	Non pre-emptive issues of equity for cash	Not applicable
(8)	As item (7), in relation to major subsidiary undertakings	Not applicable
(9)	Parent participation in a placing by a listed subsidiary	Not applicable
(10)	Contracts of significance	Not applicable
(11)	Provision of services by a controlling shareholder	Directors' Remuneration Report, starting on page 77
(12)	Shareholder waivers of dividends	Other statutory and regulatory disclosures, starting on page 94
(13)	Shareholder waivers of future dividends	Other statutory and regulatory disclosures, starting on page 94
(14)	Agreements with controlling shareholders	Other statutory and regulatory disclosures, starting on pages 94

Signed on behalf of the Board.

Jacqueline Conway

General Counsel & Company Secretary

21 October 2021

Renishaw plc
Registered number 01106260
England and Wales

Directors' responsibilities

Statement of Directors' responsibilities in respect of the Annual Report and Financial statements

The Directors are responsible for preparing the Annual Report and the Group and Company Financial statements in accordance with applicable law and regulations.

Company law requires the Directors to prepare Group and Company Financial statements for each financial year. Under that law the Directors are required to prepare the Group financial statements in accordance with International Financial Reporting Standards adopted pursuant to Regulation (EC) No 1606/2002 as it applies to the European Union and applicable United Kingdom law, and have elected to prepare the parent Company financial statements in accordance with United Kingdom Generally Accepted Accounting Practice (United Kingdom Accounting Standards and applicable law) including Financial Reporting Standard 101, 'Reduced Disclosure Framework'.

Under company law the Directors must not approve the Financial statements unless they are satisfied that they give a true and fair view of the state of affairs of the Group and the Company and of their profit or loss for that period.

In preparing each of the Group and Company Financial statements, the Directors are required to:

- select suitable accounting policies and then apply them consistently;
- make judgements and accounting estimates that are reasonable and prudent;
- state whether they have been prepared in accordance with applicable accounting standards; and
- prepare the Financial statements on the going concern basis unless it is inappropriate to presume that the Group and the Company will continue in business.

The Directors are responsible for keeping adequate accounting records that are sufficient to show and explain the Company's transactions and disclose with reasonable accuracy at any time the financial position of the Group and the Company, and enable them to ensure that the Financial statements comply with the Companies Act 2006. They are also responsible for safeguarding the assets of the Group and the Company and hence for taking reasonable steps for the prevention and detection of fraud and other irregularities.

The Directors are responsible for the maintenance and integrity of the corporate and financial information included on the Company's website. Legislation in the UK governing the preparation and dissemination of financial statements may differ from legislation in other jurisdictions.

Under applicable law and regulations, the Directors are also responsible for preparing a Strategic Report, Directors' Report, Directors' Remuneration Report and corporate governance statement that comply with the relevant laws and regulations.

Directors' confirmations

Each of the Directors, whose names and functions can be found on pages 60–61, confirms that, to the best of his or her knowledge:

- the Financial statements, prepared in accordance with the applicable set of accounting standards, give a true and fair view of the assets, liabilities, financial position and profit or loss of the Group and of the Company and the undertakings included in the consolidation taken as a whole; and
- the Strategic Report and the Directors' Report include a fair review of the development and performance of the business during the year and the position of the Group and of the Company at the year end, together with a description of the principal risks and uncertainties that they face.

The Directors consider that the Annual Report, taken as a whole, is fair, balanced and understandable, and provides the information necessary for shareholders to assess the Group's position and performance, business model and strategy.

Signed on behalf of the Board.

Allen Roberts

Group Finance Director

21 October 2021

Independent Auditor's Report to the members of Renishaw plc

Opinion

In our opinion:

- Renishaw plc's Group financial statements and Parent Company financial statements (the "financial statements") give a true and fair view of the state of the Group's and of the Parent Company's affairs as at 30 June 2021 and of the Group's profit for the year then ended;
- the Group financial statements have been properly prepared in accordance with International Accounting Standards in conformity with the requirements of the Companies Act 2006 and International Financial Reporting Standards adopted pursuant to Regulation (EC) No. 1606/2002 as it applies in the European Union;
- the Parent Company financial statements have been properly prepared in accordance with United Kingdom Generally Accepted Accounting Practice; and
- the financial statements have been prepared in accordance with the requirements of the Companies Act 2006.

We have audited the financial statements of Renishaw plc (the 'Parent Company') and its subsidiaries (the 'Group') for the year ended 30 June 2021 which comprise:

Group	Parent company
Consolidated balance sheet as at 30 June 2021	Balance sheet as at 30 June 2021
Consolidated income statement for the year then ended	Statement of changes in equity for the year then ended
Consolidated statement of comprehensive income for the year then ended	Related notes C.30 to C.45 to the financial statements including a summary of significant accounting policies
Consolidated statement of changes in equity for the year then ended	
Consolidated statement of cash flow for the year then ended	
Related notes 1 to 29 to the financial statements, including a summary of significant accounting policies	

The financial reporting framework that has been applied in the preparation of the Group financial statements is applicable law International Accounting Standards in conformity with the requirements of the Companies Act 2006 and International Financial Reporting Standards adopted pursuant to Regulation (EC) No. 1606/2002 as it applies in the European Union. The financial reporting framework that has been applied in the preparation of the Parent Company financial statements is applicable law and United Kingdom Accounting Standards, including FRS 101 "Reduced Disclosure Framework" (United Kingdom Generally Accepted Accounting Practice).

Basis for opinion

We conducted our audit in accordance with International Standards on Auditing (UK) (ISAs (UK)) and applicable law. Our responsibilities under those standards are further described in the Auditor's responsibilities for the audit of the financial statements section of our report. We are independent of the Group in accordance with the ethical requirements that are relevant to our audit of the financial statements in the UK, including the FRC's Ethical Standard as applied to listed public interest entities, and we have fulfilled our other ethical responsibilities in accordance with these requirements.

We believe that the audit evidence we have obtained is sufficient and appropriate to provide a basis for our opinion.

Conclusions relating to going concern

In auditing the financial statements, we have concluded that the Directors' use of the going concern basis of accounting in the preparation of the financial statements is appropriate. Our evaluation of the Directors' assessment of the Group and Parent Company's ability to continue to adopt the going concern basis of accounting included:

- We understood the process undertaken by management to perform the going concern assessment, including the Group's access to available sources of liquidity and its sources of debt.
- We obtained management's going concern assessment, including the cash flow forecasts for the going concern period to 31 October 2022. The Group has modelled a base scenario which is at the pessimistic end of management's Group forecast; five 'severe but plausible' downside scenarios linked to the principal risks identified by management including supply chain disruption, increasing material costs and reductions to revenue as a result of industry or macro-economic factors; and a reverse stress test based on liquidity in order to determine how much additional downside in trading could be absorbed before the Group exhausted its net cash and bank deposit balances.
- We evaluated the key assumptions underpinning the Group's forecasts. In particular we compared the revenue growth projections to external industry forecasts for indicators of contradictory information.
- We considered the results of management's reverse stress test, assessing whether such a scenario was plausible with reference to management's forecasts, the Group's historic trading, including trading during the period impacted by Covid-19, and other information obtained throughout the audit.
- We analysed management's historic revenue forecasting accuracy.
- We tested the clerical accuracy of the models used to prepare the Group's going concern assessment and the appropriateness of the model for this purpose; and
- We assessed the appropriateness of the Group's disclosures concerning the going concern basis of preparation.

We observed that the Group held net cash and bank deposits of £215 million and had borrowings of £7 million at 30 June 2021 which are not subject to financial covenants (2020: £120 million and £12 million, respectively). Management's reverse stress test indicated the Group would have to suffer a significant decline in revenue, to a level worse than at any point during FY20 and FY21, before it exhausted its available liquidity. Revenue increased by 10.9% to £566 million (2020: £510 million) and the Group generated a pre-tax profit of £139 million for the year ended 30 June 2021 (2020: £3 million).

Based on the work we have performed, we have not identified any material uncertainties relating to events or conditions that, individually or collectively, may cast significant doubt on the Group and Parent Company's ability to continue as a going concern for the period up to 31 October 2022.

In relation to the Group and Parent Company's reporting on how they have applied the UK Corporate Governance Code, we have nothing material to add or draw attention to in relation to the Directors' statement in the financial statements about whether the Directors considered it appropriate to adopt the going concern basis of accounting.

Our responsibilities and the responsibilities of the Directors with respect to going concern are described in the relevant sections of this report. However, because not all future events or conditions can be predicted, this statement is not a guarantee as to the Group's ability to continue as a going concern.

Overview of our audit approach

Audit scope	<ul style="list-style-type: none"> – We performed an audit of the complete financial information of eight components and audit procedures on specific balances for a further five components. – The components where we performed full or specific audit procedures accounted for 95% of profit before tax adjusted for fair value gains and losses on financial instruments and third-party Formal Sale Process costs "FSP" (adjusted profit before tax, as defined in note 28 of the financial statements), 89% of revenue and 93% of total assets.
Key audit matters	<ul style="list-style-type: none"> – Management override of controls through inappropriate product revenue cut-off, accelerating revenue recognition – Management override of controls through manual journal entries posted through the consolidation process to misstate financial performance – Assessment of hedge effectiveness of forward currency contracts – Valuation of the defined benefit pension liability
Materiality	– Overall Group materiality of £6.0 million which represents 5% of adjusted profit before tax.

An overview of the scope of the Parent Company and Group audits

Tailoring the scope

Our assessment of audit risk, our evaluation of materiality and our allocation of performance materiality determine our audit scope for each company within the Group. Taken together, this enables us to form an opinion on the consolidated financial statements. We take into account size, risk profile, the organisation of the Group and effectiveness of Group-wide controls, changes in the business environment and other factors such as recent Internal audit results when assessing the level of work to be performed at each company.

In assessing the risk of material misstatement to the Group financial statements, and to ensure we had adequate quantitative coverage of significant accounts in the financial statements, of the 54 reporting components of the Group, we selected 13 components covering entities within the UK, Ireland, USA, Japan, Germany, China, India, Spain, Italy and France which represent the principal business units within the Group.

Of the 13 components selected, we performed an audit of the complete financial information of eight components ("full scope components") which were selected based on their size or risk characteristics. For the remaining five components ("specific scope components"), we performed audit procedures on specific accounts within that component that we considered had the potential for the greatest impact on the significant accounts in the financial statements either because of the size of these accounts or their risk profile.

The reporting components where we performed audit procedures accounted for 95% (2020: 90%) of the Group's adjusted profit before tax, 89% (2020: 87%) of the Group's Revenue and 93% (2020: 90%) of the Group's Total assets. For the current year, the full scope components contributed 90% (2020: 81%) of the Group's adjusted profit before tax, 80% (2020: 81%) of the Group's Revenue and 86% (2020: 84%) of the Group's Total assets. The specific scope component contributed 5% (2020: 9%) of the Group's adjusted profit before tax, 9% (2020: 6%) of the Group's Revenue and 7% (2020: 6%) of the Group's Total assets. The audit scope of these components may not have included testing of all significant accounts of the component but will have contributed to the coverage of significant accounts tested for the Group.

Of the remaining 41 components that together represent 5% of the Group's adjusted profit before tax, none are individually greater than 1% of the Group's adjusted profit before tax. For these remaining components, we performed other procedures including review scope procedures for seven components and testing consolidation journals and intercompany eliminations to respond to any potential risks of material misstatement to the Group financial statements.

Independent Auditor's Report to the members of Renishaw plc *continued*

The charts below illustrate the coverage obtained from the work performed by our audit teams.

Adjusted profit before tax

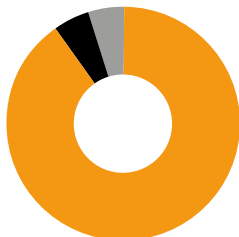

90% Full scope components
5% Specific scope components
5% Other procedures

Revenue

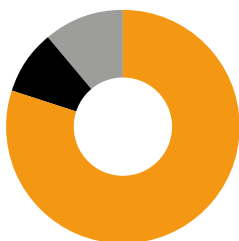

80% Full scope components
9% Specific scope components
11% Other procedures

Total assets

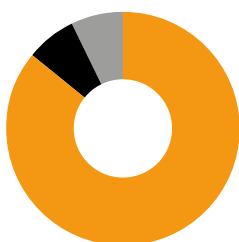

86% Full scope components
7% Specific scope components
7% Other procedures

Changes from the prior year

One specific scope component was added and another specific scope component was removed from our scope compared to 2020 due to the size of each component's contribution to the Group in 2021, resulting in no change in the total number of full and specific scope components.

Impact of the Covid-19 pandemic on the execution of our audit

As a result of the Covid-19 outbreak and resulting lockdown restrictions we have performed the majority of our audit procedures remotely. We were able to physically attend stock counts at all locations in our sample throughout May and June 2021, with the exception of Renishaw Metrology Systems Limited (India). In lieu of attending the India stock count, we reviewed the results and assessed the objectivity and competence of an independent third-party who had performed the count on behalf of management.

We have engaged virtually with a very wide range of management personnel, including those outside the finance function, throughout the period of remote working using frequent video calls, share-screen functionality, secure encrypted document exchanges and data downloads to avoid any limitation on the audit evidence required. This approach was supported through use of bespoke EY software collaboration platforms for the secure and timely delivery of requested audit evidence. All audit evidence was recorded in electronic form on our audit systems.

We worked proactively with management to agree a timetable to complete our audit procedures remotely, including considering the impact of the Formal Sales Process (FSP). We held regular video calls with key management throughout the audit to monitor progress, discuss evidence provided, and to understand accounting judgements.

Involvement with component teams

In establishing our overall approach to the Group audit, we determined the type of work that needed to be undertaken at each of the components by us, as the primary audit engagement team, or by component auditors from other EY global network firms operating under our instruction. Of the eight full scope components, audit procedures were performed on three of these directly by the primary audit team. Of the five specific scope components, audit procedures were performed on four

of these directly by the primary audit team. Where the work was performed by component auditors, we determined the appropriate level of involvement to enable us to determine that sufficient audit evidence had been obtained as a basis for our opinion on the Group as a whole.

During the current audit cycle, the Senior Statutory Auditor and other members of the Primary Team were unable to perform site visits to overseas component teams due to the travel restrictions arising from the Covid-19 pandemic. We replaced the site visits with alternative procedures, including video conference call meetings and virtual reviews of our local audit teams' working papers.

The Senior Statutory Auditor, and other members of the Primary Team, completed their reviews remotely for all overseas component teams, namely those in Ireland, Japan, Germany, China and India. The audit procedures for the other principal overseas components of the Group, namely USA, Spain, Italy and France, were performed by members of the Primary Team. We used our global audit software to enable the Senior Statutory Auditor, and other members of the Primary Team, to complete reviews of key component team working papers, particularly focussing on the Group's risk areas.

We conducted meetings using video conferencing to discuss the audit approach and execution with the component teams and to discuss audit issues arising from their work. The Senior Statutory Auditor, or other members of the Primary Team, attended key meetings with local management via video conference.

The Primary Team interacted regularly with the component teams during various stages of the audit and were responsible for the scope and direction of the audit process. We determined the appropriate level of involvement to enable us to determine that sufficient audit evidence had been obtained as a basis for our opinion on the Group as a whole. The direction, supervision and review of the component teams, together with the procedures performed by the Primary Team, gave us appropriate evidence for our opinion on the Group Financial Statements.

Key audit matters

Key audit matters are those matters that, in our professional judgment, were of most significance in our audit of the financial statements of the current period and include the most significant assessed risks of material misstatement (whether or not due to fraud) that we identified. These matters included those which had the greatest effect on: the overall audit strategy; the allocation of resources in the audit; and directing the efforts of the engagement team. These matters were addressed in the context of our audit of the financial statements as a whole, and in our opinion thereon, and we do not provide a separate opinion on these matters.

Risk	Our response to the risk	Key observations communicated to the Audit Committee
<p>Management override of controls through inappropriate product revenue cut-off, accelerating revenue recognition (£565.6 million, 2020: £510.2 million).</p> <p>Refer to the Audit Committee Report (pages 71–76); Accounting policies (pages 113–120); and Note 2 of the Group Financial Statements (page 120)</p> <p>There is an incentive for management to accelerate revenue recognition to improve financial performance, through inappropriate product revenue cut-off.</p> <p>We consider that the vast majority of Group's revenue transactions are non-complex by nature. However, management are required to exercise judgment to determine the appropriate revenue recognition of certain products which require installation such as the Raman and Additive Manufacturing products. As such, we identify a higher cut-off risk for these products as the existence of judgement gives management an opportunity to overstate the Group's financial performance.</p>	<p>We obtained an understanding of the processes and assessed the design of key controls for each of the material revenue streams.</p> <p>To test the appropriateness of product revenue cut-off, our audit procedures included, amongst others:</p> <ul style="list-style-type: none"> – Testing a sample of revenue transactions recorded before year-end by obtaining documentation to verify that revenue recognition criteria had been met. We focussed on sales of higher value equipment which requires installation, for example Raman spectroscopy and Additive Manufacturing products; and – Testing a sample of credit notes issued after year-end by obtaining documentation to verify that revenue adjustments had been recorded in the appropriate period. <p>To test the revenue transactions recorded throughout the period, our audit procedures included, amongst others;</p> <ul style="list-style-type: none"> – For a number of components which contributed 44% of total Group revenue, we used data analytics to analyse 100% of the revenue transactions recorded in the year, testing the correlation between revenue, trade receivables and cash and performing tests of detail over non-correlated transactions. – We performed representative sampling for the remaining in-scope locations where we did not use data analytics, tracing revenue transactions recorded throughout the year to cash receipts. <p>In addressing this key audit matter, audit procedures were performed by a combination of the Primary Team and each of the component audit teams under our supervision. We performed full and specific scope audit procedures over components which contributed 89% of total consolidated Group revenue, of which components contributing 53% were tested by overseas component teams under our supervision.</p>	<p>Based on the procedures performed, revenue transactions have been recognised in the appropriate period.</p> <p>Our procedures did not identify instances of inappropriate management override across the Group.</p>
<p>Management override of controls through manual journal entries posted through the consolidation process to misstate financial performance</p> <p>Refer to the Audit Committee Report (pages 71–76) and Accounting policies (pages 113–120)</p> <p>There is an incentive for management to manipulate the financial performance of the Group by recording manual top-side adjustments in the consolidation.</p> <p>The Group consolidation is a manual process, which involves the recording of a number of material top-side adjustments. The calculations behind these adjustments are manual in nature, leading to increased risk of misstatement as a result of management override.</p>	<p>We obtained an understanding of the processes and assessed the design of key controls for the Group consolidation process.</p> <p>To respond to the risk of inappropriate Group consolidation adjustments our audit procedures included, amongst others:</p> <ul style="list-style-type: none"> – For all full and specific scope locations we reconciled the inputs into the Group consolidation to the audited component trial balances. For the other components, we verify that none are individually significant to the Group and for a sample of the remaining components, we reconciled the inputs to the Group consolidation to the underlying source data; and – Testing all consolidation entries exceeding 15% of performance materiality by obtaining evidence to verify the validity and accuracy of the journals being posted. <p>Inspecting the individually insignificant consolidation journals for qualitative risk factors, such as journals which impact the Group's key performance measures, confirming that the total of these adjustments did not have a material impact on the Group's key metrics. In addressing this key audit matter, audit procedures were performed by the Primary Team.</p>	<p>Our procedures did not identify instances of inappropriate management override across the Group.</p>

Independent Auditor's Report to the members of Renishaw plc continued

Risk	Our response to the risk	Key observations communicated to the Audit Committee
<p>Assessment of hedge effectiveness of forward currency contracts (£15.4 million, 2020: £(61.0) million)</p> <p>Refer to the Audit Committee Report (pages 71–76); Accounting policies (pages 113–120); and Note 24 of the Group Financial Statements (pages 135–139)</p> <p>At 30 June 2021, the Group had designated cash flow hedges for forward currency contracts with a net fair value of £15.4 million (2020: liability of £61.0 million).</p> <p>Of the total forward currency contracts at 30 June 2021, a net fair value £1.4 million related to forward currency contracts deemed ineffective as a cash flow hedge (2020: liability of £26.1 million).</p> <p>As more fully described in the notes to the financial statements, the Group uses forward currency contracts to manage risks arising from changes in foreign currency exchange rates relating to forecast sales.</p> <p>The Group designates certain derivatives as hedges of a particular risk associated with a recognised asset or liability or a highly probable forecast transaction (cash flow hedge). Hedge accounting is discontinued when the hedging instrument expires or is sold, terminated or exercised, or no longer qualifies for hedge accounting.</p> <p>Changes in the fair value of foreign currency derivatives which are ineffective or do not meet the criteria for hedge accounting in IFRS 9 'Financial Instruments' are recognised in the income statement. For those instruments which are effective and meet the criteria for hedge accounting, the change in fair value is recognised in other comprehensive income.</p> <p>The complexity of applying hedge accounting and measuring hedge effectiveness could result in a misstatement between the income statement and other comprehensive income.</p>	<p>We obtained an understanding of management's process and assessed the design of key controls for applying hedge accounting and estimating hedge effectiveness.</p> <p>To test the appropriateness of applying hedge accounting and the assessment of hedge effectiveness, our audit procedures included, amongst others:</p> <ul style="list-style-type: none"> – Involving EY treasury specialists as part of our team to, for a sample of hedge accounting relationships: <ol style="list-style-type: none"> i) assess the appropriateness of the methodology used by management to apply hedge accounting. We inspected management's hedge documentation and assessed the economic relationship to ensure compliance with the requirements of IFRS 9; and ii) independently re-perform the ineffectiveness measurement. We compared the result of our assessment to management's, to evaluate whether management's measurement of ineffectiveness was within an acceptable range. – Assessing management's sales forecasts, including the extent to which these have been deemed to be 'highly probable', by evaluating management's historical forecasting accuracy and comparing the revenue growth assumptions to third party industry forecasts; and – Evaluating the disclosures in the Group financial statements. <p>In addressing this key audit matter, audit procedures were performed by the Primary Team.</p>	<p>Based on the audit procedures performed, we confirmed that the Group's application of hedge accounting for forward currency contracts, the hedge effectiveness assessment and the resultant classification of changes in fair value between the income statement and other comprehensive income, were in accordance with the requirements of IFRS 9 'Financial Instruments'.</p> <p>The disclosures provided in note 24 to the Group Financial Statements are appropriate.</p>

Risk	Our response to the risk	Key observations communicated to the Audit Committee
<p>Valuation of the defined benefit pension liability (£255.1 million, 2020: £253.5 million)</p> <p>Refer to the Audit Committee Report (pages 71–76); Accounting policies (page 113) and Note 22 of the Group Financial Statements (pages 132–134)</p> <p>A total defined benefit pension liability of £255.1 million was held at 30 June 2021 in respect of Group schemes in the UK, United States and Ireland. As a result of the size of the liability, the level of judgement involved in estimating the liability, and the fact that relatively small movements in assumptions can result in a material impact to the financial statements there is an increased risk of material misstatement.</p> <p>As more fully described in note 22 of the Group Financial Statements, following various legal interpretations of the UK defined benefit scheme Trust Deed the Company and Trustees jointly instructed the Queen's Counsel to opine on the legal position concerning the Late Retirement Factor (LRF) which impacts the estimated future benefit payments to certain plan members. As a result of the Queen's Counsel ruling, management updated their estimate of the future pension benefits in this period, resulting in a £14.3 million reduction in the liability.</p> <p>The sensitivity to changes in key assumptions including the discount rate; rate of inflation; mortality assumptions, and the UK scheme LRF which was subject to the Queen's Counsel ruling, could result in a misstatement of the defined benefit liability.</p>	<p>We obtained an understanding of the processes and assessed the design of key controls for estimating the defined benefit pension liability.</p> <p>To test the appropriateness of the defined benefit pension liability, our audit procedures included, amongst others:</p> <ul style="list-style-type: none"> – Evaluating the competence and objectivity of management's external actuarial specialists and assessing the completeness and accuracy of the member data used by the actuaries to estimate the scheme liabilities by testing the clerical accuracy of the member data schedules and performing an analytical review of the year-on-year movements in the data. – Involving EY actuarial specialists as part of our team to independently estimate an acceptable range for each of the significant assumptions used in estimating the UK and Irish scheme liabilities, which included the discount rate; rate of inflation; and mortality assumptions. We compared each of the significant assumptions used by management's actuarial specialist to our independent acceptable range. – Comparing the key assumptions used in the estimate of the US scheme liability to appropriate market data and performing an analytical review of the change in each key assumption compared to the previous period. – Inspecting the Queen's Counsel ruling on the UK scheme Trust Deed and evaluating whether it had been reasonably reflected in the UK scheme liability and whether it was appropriate to account for as a change in estimate in accordance with IAS 8 – <i>Accounting Policies, Changes in Accounting Estimates and Errors</i>; and – Evaluating the disclosures in the Group financial statements. <p>In addressing this key audit matter, audit procedures were performed by the Primary Team.</p>	<p>The key assumptions used to estimate the defined benefit pension liability are within our accepted range.</p> <p>The disclosures provided in note 22 to the Group Financial Statements are appropriate.</p>

In the prior year, our auditor's report included key audit matters in relation to;

- “The impact of Covid-19, including on the Company's Going Concern Assessment”. In the current year, the effects of Covid-19 have not had a pervasive impact on the financial statements, including the going concern assessment and other key areas of estimation and judgment.

Independent Auditor's Report to the members of Renishaw plc continued

Our application of materiality

We apply the concept of materiality in planning and performing the audit, in evaluating the effect of identified misstatements on the audit and in forming our audit opinion.

Materiality

The magnitude of an omission or misstatement that, individually or in the aggregate, could reasonably be expected to influence the economic decisions of the users of the financial statements. Materiality provides a basis for determining the nature and extent of our audit procedures.

We determined materiality for the Group to be £6.0 million (2020: £2.4 million), which is 5% (2020: 5%) of adjusted profit before tax, as defined in note 28 of the Group financial statements. We believe that adjusted profit before tax, which excludes the gains from fair value of financial instruments and third-party FSP costs, is the most relevant performance measure to the stakeholders of the Group. We consider third-party FSP costs to be non-recurring by nature and therefore not reflective of the recurring performance of the Group. Fair value gains and losses are significantly impacted by the volatility in the valuation of derivative financial instruments, which is outside of the control of the group and also not reflective of the Group's recurring performance.

Our initial planning materiality was calculated at £4.0 million, based on management's 2021 forecast of adjusted profit before tax. During the course of our audit, we continually reassessed our materiality, considering management's latest forecasts and the actual results for

the year. Our final planning materiality, considering actual results for the year ended 30 June 2021, was £6.0 million (2020: £4.0 million).

We determined materiality for the Parent Company to be £8.0 million (2020: £5.9 million), which is 1% of equity.

Performance materiality

The application of materiality at the individual account or balance level. It is set at an amount to reduce to an appropriately low level the probability that the aggregate of uncorrected and undetected misstatements exceeds materiality.

On the basis of our risk assessment, together with our assessment of the Group's overall control environment, our judgement was that performance materiality was 75% (2020: 75%) of our planning materiality, namely £4.5 million (2020: £3.0 million). We have set performance materiality at this percentage due to the past history of few misstatements indicating a lower risk of misstatement in the financial statements.

Audit work at component locations for the purpose of obtaining audit coverage over significant financial statement accounts is undertaken based on a percentage of total performance materiality.

The performance materiality set for each component is based on the relative scale and risk of the component to the Group as a whole and our assessment of the risk of misstatement at that component. In the current year, the range of performance materiality allocated to components was £0.3 million to £2.9 million (2020: £0.1 million to £1.1 million).

Reporting threshold

An amount below which identified misstatements are considered as being clearly trivial.

We agreed with the Audit Committee that we would report to them all uncorrected audit differences in excess of £0.3 million (2020: £0.1 million), which is set at 5% of planning materiality, as well as differences below that threshold that, in our view, warranted reporting on qualitative grounds.

We evaluate any uncorrected misstatements against both the quantitative measures of materiality discussed above and in light of other relevant qualitative considerations in forming our opinion.

Other information

The other information comprises the information included in the Annual Report set out on pages 1–97 and 156–160, including the Strategic Report set out on pages 1–57, Governance set out on pages 58–97 and Shareholder information set out on pages 156–160, other than the financial statements and our Independent Auditor's Report thereon. The Directors are responsible for the other information contained within the Annual Report.

Our opinion on the financial statements does not cover the other information and, except to the extent otherwise explicitly stated in this report, we do not express any form of assurance conclusion thereon.

Our responsibility is to read the other information and, in doing so, consider whether the other information is materially inconsistent with the financial statements or our knowledge obtained in the course of the audit or otherwise appears to be materially misstated. If we identify such material inconsistencies or apparent material misstatements, we are required to determine whether there is a material misstatement in the financial statements themselves. If, based on the work we have performed, we conclude that there is a material misstatement of the other information, we are required to report that fact.

We have nothing to report in this regard.

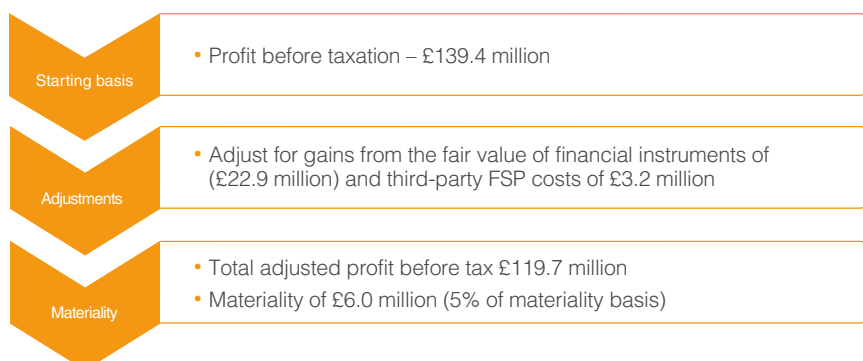

Opinions on other matters prescribed by the Companies Act 2006

In our opinion, the part of the Directors' Remuneration Report to be audited has been properly prepared in accordance with the Companies Act 2006.

In our opinion, based on the work undertaken in the course of the audit:

- the information given in the Strategic Report and the Directors' Report for the financial year for which the financial statements are prepared is consistent with the financial statements; and
- the Strategic Report and the Directors' Report have been prepared in accordance with applicable legal requirements.

Matters on which we are required to report by exception

In the light of the knowledge and understanding of the Group and the Parent Company and its environment obtained in the course of the audit, we have not identified material misstatements in the Strategic Report or the Directors' Report.

We have nothing to report in respect of the following matters in relation to which the Companies Act 2006 requires us to report to you if, in our opinion:

- adequate accounting records have not been kept by the Parent Company, or returns adequate for our audit have not been received from branches not visited by us; or
- the Parent Company financial statements and the part of the Directors' Remuneration Report to be audited are not in agreement with the accounting records and returns; or
- certain disclosures of Directors' remuneration specified by law are not made; or
- we have not received all the information and explanations we require for our audit

Corporate Governance Statement

The Listing Rules require us to review the Directors' statement in relation to going concern, longer-term viability and that part of the Corporate Governance Statement relating to the Group and Company's compliance with the provisions of the UK Corporate Governance Code specified for our review.

Based on the work undertaken as part of our audit, we have concluded that each of the following elements of the Corporate Governance Statement is materially consistent with the financial statements or our knowledge obtained during the audit:

- Directors' statement with regards to the appropriateness of adopting the going concern basis of accounting and any material uncertainties identified set out on page 67;
- Directors' explanation as to its assessment of the company's prospects, the period this assessment covers and why the period is appropriate set out on pages 44 and 45;
- Directors' statement on fair, balanced and understandable set out on page 74;
- Board's confirmation that it has carried out a robust assessment of the emerging and principal risks set out on pages 30 to 43;
- The section of the Annual Report that describes the review of effectiveness of risk management and internal control systems set out on page 67; and;
- The section describing the work of the Audit Committee set out on pages 71 to 76.

Responsibilities of Directors

As explained more fully in the Directors' responsibilities statement set out on page 97, the Directors are responsible for the preparation of the financial statements and for being satisfied that they give a true and fair view, and for such internal control as the Directors determine is necessary to enable the preparation of financial statements that are free from material misstatement, whether due to fraud or error.

In preparing the financial statements, the Directors are responsible for assessing the Group and Parent Company's ability to continue as a going concern, disclosing, as applicable, matters related to going concern and using the going concern basis of accounting unless the Directors either intend to liquidate the Group or the Parent Company or to cease operations, or have no realistic alternative but to do so.

Auditor's responsibilities for the audit of the financial statements

Our objectives are to obtain reasonable assurance about whether the financial statements as a whole are free from material misstatement, whether due to fraud or error, and to issue an Auditor's Report that includes our opinion. Reasonable assurance is a high level of assurance, but is not a guarantee that an audit conducted in accordance with ISAs (UK) will always detect a material misstatement when it exists. Misstatements can arise from fraud or error and are considered material if, individually or in the aggregate, they could reasonably be expected to influence the economic decisions of users taken on the basis of these financial statements.

Independent Auditor's Report

to the members of Renishaw plc continued

Explanation as to what extent the audit was considered capable of detecting irregularities, including fraud

Irregularities, including fraud, are instances of non-compliance with laws and regulations. We design procedures in line with our responsibilities, outlined above, to detect irregularities, including fraud. The risk of not detecting a material misstatement due to fraud is higher than the risk of not detecting one resulting from error, as fraud may involve deliberate concealment by, for example, forgery or intentional misrepresentations, or through collusion. The extent to which our procedures are capable of detecting irregularities, including fraud is detailed below.

However, the primary responsibility for the prevention and detection of fraud rests with both those charged with governance of the company and management.

- We obtained an understanding of the legal and regulatory frameworks that are applicable to the Group and determined that the most significant are those that relate to the reporting framework (IFRS, FRS 101 and the Companies Act 2006, the Financial Reporting Council (FRC) and the UK Corporate Governance Code) and the relevant tax compliance regulations in the UK and overseas jurisdictions in which the Group operates. In addition, we concluded that there are certain significant laws and regulations which may have an effect on the determination of the amounts and disclosures in the financial statements being the Listing Rules of the London Stock Exchange, the Bribery Act 2010, Occupational Health and Safety Regulations, the Data Protection Act, and export controls.

- We understood how the Group is complying with those frameworks by reading internal policies and codes of conduct and assessing the entity level control environment, including the level of oversight of those charged with governance.

- Based on this understanding we designed our audit procedures to identify non-compliance with such laws and regulations. Our procedures included making enquiries of management, including the Group's legal counsel, internal audit and management of each full scope component of known instances of non-compliance or suspected non-compliance with laws and regulations; attendance at audit committee meetings; review of committee and board meeting minutes, including board meeting minutes for full scope components to identify any non-compliance with laws and regulations; and journal entry testing, with a focus on journals meeting our defined risk criteria based on our understanding of the business.

- We assessed the susceptibility of the Group's financial statements to material misstatement, including how fraud might occur by considering the programs and controls that the Group has established to address risks identified by the entity, or that otherwise prevent, deter and detect fraud; how senior management monitor those programs and controls, evaluating conditions in the context of incentive/pressure to commit fraud, considering the opportunity to commit fraud and the potential rationalisation of the fraudulent act, and by making enquiries of senior management, including the Group Finance Director, Head of Group Finance, Group Internal Audit Manager and Chair of the Audit Committee. We planned our audit to identify risks of management override, tested higher risk journal entries and performed audit procedures to address the potential for management bias, particularly over areas involving significant estimation. Further discussion of our approach to address the identified risks of management override are set out in the key audit matters section of our report.

A further description of our responsibilities for the audit of the financial statements is located on the Financial Reporting Council's website at www.frc.org.uk/auditorsresponsibilities. This description forms part of our Auditor's Report.

Other matters we are required to address

- Following the recommendation of the Audit Committee we were appointed by the Parent Company on 13 October 2016 to audit the financial statements for the year ending 30 June 2017 and subsequent financial periods.
- The period of total uninterrupted engagement including previous renewals and reappointments is five years, covering the years ending 30 June 2017 to 30 June 2021.
- The non-audit services prohibited by the FRC's Ethical Standard were not provided to the Group or the Parent Company and we remain independent of the Group and the Parent Company in conducting the audit.
- The audit opinion is consistent with the additional report to the audit committee

Use of our report

This report is made solely to the company's members, as a body, in accordance with Chapter 3 of Part 16 of the Companies Act 2006. Our audit work has been undertaken so that we might state to the company's members those matters we are required to state to them in an Auditor's Report and for no other purpose. To the fullest extent permitted by law, we do not accept or assume responsibility to anyone other than the company and the company's members as a body, for our audit work, for this report, or for the opinions we have formed.

Paul Mapleston

(Senior Statutory Auditor)
for and on behalf of Ernst & Young LLP,
Statutory Auditor
Bristol

21 October 2021

Financial statements contents

Introduction

The Directors are responsible for preparing the Annual Report and the Group and Company financial statements in accordance with applicable law and regulations. The full statement of Directors' responsibilities can be found on page 97.

The notes (forming part of the financial statements) provide additional information required by statute, accounting standards or other regulations to assist in a more detailed understanding of the primary financial statements. The basis of preparation section (see note 1) provides details of accounting policies that apply to transactions and balances in general.

Consolidated financial statements

Primary statements

108	Consolidated income statement
109	Consolidated statement of comprehensive income and expense
110	Consolidated balance sheet
111	Consolidated statement of changes in equity
112	Consolidated statement of cash flow

Notes (forming part of the financial statements)

113	1. Accounting policies
120	2. Segmental analysis
122	3. Personnel expenses
122	4. Cost of sales
123	5. Financial income and expenses
123	6. Profit before tax
123	7. Earnings per share
124	8. Income tax expense
124	9. Deferred tax
126	10. Property, plant and equipment
126	11. Right-of-use assets
127	12. Intangible assets
128	13. Investments in associates and joint ventures
129	14. Leases (as lessor)
130	15. Bank deposits and cash and cash equivalents
130	16. Inventories
130	17. Provisions
130	18. Contract liabilities
131	19. Other payables
131	20. Leases (as lessee)
131	21. Borrowings
132	22. Employee benefits
135	23. Share-based payments
135	24. Financial instruments
139	25. Share capital and reserves
141	26. Capital commitments
141	27. Related parties
141	28. Alternative performance measures
143	29. Restructuring costs

Company financial statements

Primary statements

144	Company balance sheet
145	Company statement of changes in equity

Notes to the Company financial statements

146	C.30. Accounting policies
148	C.31. Property, plant and equipment
148	C.32. Intangible assets
149	C.33. Investments in subsidiaries
149	C.34. Investments in associates and joint ventures
149	C.35. Deferred tax
149	C.36. Inventories
150	C.37. Trade receivables
150	C.38. Provisions
150	C.39. Other payables
150	C.40. Employee benefits
151	C.41. Share capital
152	C.42. Related parties
152	C.43. Capital commitments
152	C.44. Subsidiary undertakings
155	C.45. Associated undertakings and joint ventures

Consolidated income statement

for the year ended 30 June 2021

from continuing operations	notes	2021 £'000	2020 £'000
Revenue	2	565,559	510,215
Cost of sales	4	(269,852)	(271,633)
Gross profit		295,707	238,582
Distribution costs		(110,087)	(123,276)
Administrative expenses		(69,257)	(58,584)
Restructuring costs	29	–	(23,797)
Gains/(losses) from the fair value of financial instruments	24	21,978	(26,631)
Operating profit		138,341	6,294
Financial income	5	3,406	913
Financial expenses	5	(3,991)	(4,840)
Share of profits of associates and joint ventures	13	1,683	841
Profit before tax	6	139,439	3,208
Income tax expense	8	(27,980)	(2,920)
Profit for the year		111,459	288
Profit attributable to:			
Equity shareholders of the parent company		111,459	288
Non-controlling interest	25	–	–
Profit for the year		111,459	288
		pence	pence
Dividend per share arising in respect of the year	25	66.0	0.0
Dividend per share paid in the year	25	14.0	46.0
Earnings per share (basic and diluted)	7	153.2	0.4

Consolidated statement of comprehensive income and expense

for the year ended 30 June 2021

	notes	2021 £'000	2020 £'000
Profit for the year		111,459	288
Other items recognised directly in equity:			
Items that will not be reclassified to the Consolidated income statement:			
Current tax on contributions to defined benefit pension schemes		1,653	–
Deferred tax on contributions to defined benefit pension schemes		(1,653)	–
Remeasurement of defined benefit pension scheme liabilities	22	33,285	(23,978)
Deferred tax on remeasurement of defined benefit pension scheme liabilities		(6,052)	5,484
Total for items that will not be reclassified		27,233	(18,494)
Items that may be reclassified to the Consolidated income statement:			
Exchange differences in translation of overseas operations	25	(14,752)	3,369
Exchange differences in translation of overseas joint venture	25	(728)	186
Current tax on translation of net investments in foreign operations	25	735	–
Deferred tax on translation of net investments in foreign operations	25	735	(403)
Effective portion of changes in fair value of cash flow hedges, net of recycling	25	51,590	13,924
Deferred tax on effective portion of changes in fair value of cash flow hedges	25	(9,790)	(1,978)
Total for items that may be reclassified		27,790	15,098
Total other comprehensive income and expense, net of tax		55,023	(3,396)
Total comprehensive income and expense for the year		166,482	(3,108)
Attributable to:			
Equity shareholders of the parent company		166,482	(3,108)
Non-controlling interest	25	–	–
Total comprehensive income and expense for the year		166,482	(3,108)

Consolidated balance sheet

at 30 June 2021

	notes	2021 £'000	2020 £'000
Assets			
Property, plant and equipment	10	246,242	270,049
Right-of-use assets	11	12,429	12,672
Intangible assets	12	43,795	43,364
Investments in associates and joint ventures	13	16,634	16,604
Long-term loans to associates and joint ventures	13	–	2,818
Finance lease receivables	14	6,241	4,801
Deferred tax assets	9	21,292	39,641
Derivatives	24	12,484	1,242
Total non-current assets		359,117	391,191
Current assets			
Inventories	16	113,563	105,497
Trade receivables	24	114,661	105,077
Finance lease receivables	14	1,763	1,982
Contract assets		332	606
Short-term loans to associates and joint ventures	13	598	318
Current tax		1,600	3,878
Other receivables	24	30,021	23,196
Derivatives	24	9,639	3,758
Pension scheme cash escrow account	22	10,578	10,568
Bank deposits	15	120,000	10,000
Cash and cash equivalents	15,24	95,008	110,386
Total current assets		497,763	375,266
Current liabilities			
Trade payables	24	24,715	16,998
Contract liabilities	18	6,120	5,976
Current tax		4,680	2,905
Provisions	17	6,259	5,591
Derivatives	24	5,594	22,546
Lease liabilities	20	3,904	4,241
Borrowings	21	992	1,061
Other payables	19	51,716	34,372
Total current liabilities		103,980	93,690
Net current assets		393,783	281,576
Non-current liabilities			
Lease liabilities	20	8,658	8,925
Borrowings	21	6,457	10,482
Employee benefits	22	23,698	64,895
Deferred tax liabilities	9	10,402	499
Derivatives	24	355	41,102
Total non-current liabilities		49,570	125,903
Total assets less total liabilities		703,330	546,864
Equity			
Share capital	25	14,558	14,558
Share premium		42	42
Own shares held	25	(404)	(404)
Currency translation reserve	25	3,719	17,729
Cash flow hedging reserve	25	11,345	(30,455)
Retained earnings		674,603	546,100
Other reserve	25	44	(129)
Equity attributable to the shareholders of the parent company		703,907	547,441
Non-controlling interest	25	(577)	(577)
Total equity		703,330	546,864

These financial statements were approved by the Board of Directors on 21 October 2021 and were signed on its behalf by:

Sir David McMurtry

Allen Roberts

Directors

Consolidated statement of changes in equity

for the year ended 30 June 2021

	Share capital £'000	Share premium £'000	Own shares held £'000	Currency translation reserve £'000	Cash flow hedging reserve £'000	Retained earnings £'000	Other reserve £'000	Non-controlling interest £'000	Total £'000
Year ended 30 June 2020									
Balance at 1 July 2019	14,558	42	(404)	14,577	(42,401)	597,784	(302)	(577)	583,277
Profit for the year	-	-	-	-	-	288	-	-	288
Other comprehensive income and expense (net of tax)									
Remeasurement of defined benefit pension scheme liabilities	-	-	-	-	-	(18,494)	-	-	(18,494)
Foreign exchange translation differences	-	-	-	2,965	-	-	-	-	2,965
Relating to associates and joint ventures	-	-	-	187	-	-	-	-	187
Changes in fair value of cash flow hedges	-	-	-	-	11,946	-	-	-	11,946
Total other comprehensive income and expense	-	-	-	3,152	11,946	(18,494)	-	-	(3,396)
Total comprehensive income and expense	-	-	-	3,152	11,946	(18,206)	-	-	(3,108)
Share-based payments charge	-	-	-	-	-	-	173	-	173
Dividends paid	-	-	-	-	-	(33,478)	-	-	(33,478)
Balance at 30 June 2020	14,558	42	(404)	17,729	(30,455)	546,100	(129)	(577)	546,864
Year ended 30 June 2021									
Profit for the year	-	-	-	-	-	111,459	-	-	111,459
Other comprehensive income and expense (net of tax)									
Remeasurement of defined benefit pension scheme liabilities	-	-	-	-	-	27,233	-	-	27,233
Foreign exchange translation differences	-	-	-	(13,282)	-	-	-	-	(13,282)
Relating to associates and joint ventures	-	-	-	(728)	-	-	-	-	(728)
Changes in fair value of cash flow hedges	-	-	-	-	41,800	-	-	-	41,800
Total other comprehensive income and expense	-	-	-	(14,010)	41,800	27,233	-	-	55,023
Total comprehensive income and expense	-	-	-	(14,010)	41,800	138,692	-	-	166,482
Share-based payments charge	-	-	-	-	-	-	173	-	173
Dividends paid	-	-	-	-	-	(10,189)	-	-	(10,189)
Balance at 30 June 2021	14,558	42	(404)	3,719	11,345	674,603	44	(577)	703,330

More details of share capital and reserves are given in note 25.

Consolidated statement of cash flow

for the year ended 30 June 2021

	notes	2021 £'000	2020 £'000
Cash flows from operating activities			
Profit for the year		111,459	288
Adjustments for:			
Depreciation of property, plant and equipment and right-of-use assets	10,11	28,780	30,578
Loss on sale of property, plant and equipment		31	22
Impairment of property, plant and equipment	10	–	2,590
Amortisation of development costs	12	9,019	16,861
Impairment of development costs	12	1,092	15,881
Amortisation of other intangibles	12	1,205	1,566
Loss on disposal of other intangibles		–	53
Impairment of other intangibles	12	–	1,600
Impairment of goodwill	12	–	808
Share of profits from associates and joint ventures	13	(1,683)	(841)
Profit on disposal of investment in associate		–	(1,053)
Fair value gain on revaluation of investment in associate		–	(2,775)
Impairment of investment in associate	13	1,674	257
Impairment of long-term loan to associate	13	2,633	1,297
Remeasurement of defined benefit pension scheme liabilities from GMP equalisation	22	78	–
Financial income	5	(3,406)	(913)
Financial expenses	5	3,991	4,840
(Gains)/losses from the fair value of financial instruments	28	(22,995)	21,609
Share-based payment expense	23	173	173
Tax expense	8	27,980	2,920
		48,572	95,473
(Increase)/decrease in inventories		(8,066)	23,529
(Increase)/decrease in trade and other receivables		(25,703)	16,342
Increase/(decrease) in trade and other payables		27,216	(11,297)
Increase in provisions	17	668	2,745
		(5,885)	31,319
Defined benefit pension contributions	22	(8,866)	(11,816)
Income taxes paid		(9,991)	(10,605)
Cash flows from operating activities		135,289	104,659
Investing activities			
Purchase of property, plant and equipment	10	(10,873)	(38,657)
Sale of property, plant and equipment		33	3,633
Development costs capitalised	12	(9,844)	(17,405)
Purchase of other intangibles	12	(3,000)	(3,338)
(Increase)/decrease in bank deposits	15	(110,000)	42,500
Interest received	5	625	835
Dividends received from associates and joint ventures	13	–	512
Purchase of additional shareholding in joint venture	13	(749)	–
Proceeds from sale of shares in associate		–	986
Cash flows from investing activities		(133,808)	(10,934)
Financing activities			
Increase in borrowings	21	636	1,894
Repayment of borrowings	21	(3,477)	(1,136)
Interest paid	5	(386)	(1,315)
Repayment of principal of lease liabilities	20	(4,815)	(4,130)
Dividends paid	25	(10,189)	(33,478)
Cash flows from financing activities		(18,231)	(38,165)
Net increase in cash and cash equivalents		(16,750)	55,560
Cash and cash equivalents at the beginning of the year		110,386	54,326
Effect of exchange rate fluctuations on cash held		1,372	500
Cash and cash equivalents at the end of the year	15	95,008	110,386

Notes (forming part of the financial statements)

1. Accounting policies

Basis of preparation

Renishaw plc (the Company) is a company incorporated in England and Wales. The Group financial statements consolidate those of the Company and its subsidiaries (together referred to as the Group) and equity account the Group's interest in associates and joint ventures. The parent company financial statements present information about the Company as a separate entity and not about the Group.

The Group financial statements have been prepared and approved by the Directors in accordance with International Accounting Standards in conformity with the requirements of the Companies Act 2006 and in accordance with International Financial Reporting Standards pursuant to Regulation (EC) No.1606/2002 as it applies in the European Union ('adopted IFRS'). The parent company financial statements have been prepared in accordance with Financial Reporting Standard 101 'Reduced Disclosure Framework'. The consolidated financial statements are presented in Sterling, which is the Company's functional currency and the Group's presentational currency, and all values are rounded to the nearest thousand (£'000).

The accounting policies set out below have, unless otherwise stated, been applied consistently to all periods presented in these Group financial statements. Judgements made by the Directors, in the application of these accounting policies, that have a significant effect on the financial statements and estimates with a significant risk of material adjustment in the next year are noted below.

Critical accounting judgements and estimation uncertainties

The preparation of financial statements in conformity with adopted IFRS requires management to make judgements, estimates and assumptions that affect the application of policies and reported amounts of assets and liabilities, income and expenses. The estimates and associated assumptions are based on historical experience and various other factors that are believed to be reasonable under the circumstances, the results of which form the basis of making the judgements about carrying values of assets and liabilities that are not readily apparent from other sources. Actual results may differ from these estimates. The estimates and underlying assumptions are reviewed on an ongoing basis.

The areas of key estimation uncertainty and critical accounting judgement that have a significant risk of causing a material adjustment to the carrying amount of assets and liabilities in the next financial year are summarised below, with further details included within accounting policies as indicated.

Item	Key judgements (J) and estimates (E)	Page
Cash flow hedges	E – Estimates of highly probable forecasts of the hedged item	117
Research and development costs	J – Whether a project meets the criteria for capitalisation	117
Goodwill and capitalised development costs	E – Estimates of future cash flows for impairment testing	118
Inventories	E – Determination of net realisable value	118
Defined benefit pension schemes	E – Valuation of defined benefit pension schemes' liabilities	119
Taxation	E – Estimates of future profits to use deferred tax assets	120

New, revised or changes to existing accounting standards

The following accounting standard amendments became effective as at 1 January 2020 and have been adopted in the preparation of these financial statements, with effect from 1 July 2020:

- amendments to IFRS 3, Definition of a Business;
- amendments to IFRS 7, IFRS 9 and IAS 39, Interest Rate Benchmark Reform;
- amendments to IAS 1 and IAS 8, Definition of Material;
- amendments to References to the Conceptual Framework for Financial Reporting; and
- amendments to IFRS 16, COVID-19-Related Rent Concessions.

These have not had a material effect on these financial statements.

Going concern

In preparing these financial statements, the Directors have adopted the going concern basis. The decision to adopt the going concern basis was made after considering:

- the Group's business model and key markets, as set out on page 4;
- the Group's risk management processes and principal risks, disclosed on page 30;
- the Group's financial resources and strategies (page 20); and
- the process undertaken to review the Group's viability, including scenario testing, as set out on pages 113–114 and which included considering the potential future impact of COVID-19 on the Group.

In the viability review the Directors assessed the period to 31 October 2024, using the 'highly probable' revenue forecasts used by the Group for hedge accounting, and 'severe but plausible' downside scenarios. In making the going concern assessment, the Directors used the same forecasts but assessed the period to 31 October 2022.

Notes continued

1. Accounting policies (continued)

The scenarios were:

Base scenario – pessimistic revenue forecast from the Group's business plan, with overheads, capital expenditure, and other cash outflows following the route of the optimistic revenue forecast from the same business plan. Essentially, this means continuing to plan for the growth in the business plan, including the costs that would need to be incurred in the period to 31 October 2022 to achieve revenue growth in following years, while assuming that revenue growth is at the lowest end of our corporate view. The pessimistic revenue forecasts are used as the 'highly probable' revenue forecasts used in hedge accounting. For context, revenue in the first year of the base scenario is a small increase over 2021's revenue of £565.6m.

The 'severe but plausible' scenarios then took the base scenario ('scenario 1') and considered the further effect of:

- 2) Supply-chain disruption causing a loss in revenue, due to not being able to fulfil all orders and some permanent loss of customers if this disruption caused them to move to our competitors;
- 3) Industry fluctuations and/or macroeconomic conditions causing revenue to significantly reduce;
- 4) Supply-chain disruption occurring at the same time as the industry fluctuations and/or macroeconomic conditions, combining scenarios 2 and 3;
- 5) Industry fluctuations and/or macroeconomic conditions causing revenue to significantly reduce, and also causing a significant deterioration in debtor days; and
- 6) Supply-chain disruption and economic uncertainty result in a significant rise in material costs, and therefore a fall in gross margin.

In all six scenarios, the Group had significant positive cash balances throughout the period to 31 October 2022.

For our other principal risks, no further separate scenarios were modelled. For risks such as People, Innovation strategy, and Capital allocation, the Directors felt that if these risks crystallised they would result in the restriction of longer-term growth rather than having a significant financial effect in the short term. For other principal risks, the Directors considered that the existing scenarios sufficiently modelled a range of outcomes, including what would happen if multiple risks crystallised at the same time, and that the outcomes of other risks crystallising would be no worse than the existing scenarios.

Emerging risks of climate change and changing work patterns have also been reviewed by the Directors when considering the impact and likelihood of principal risks crystallising.

We also performed reverse stress testing to identify what would need to happen in the period to 31 October 2022 to result in the Group having negative bank deposit and cash balances. We found that this would occur if revenue fell to £12m per month before mitigating actions were taken; this is considerably lower than forecast, and well below the lowest revenue months experienced in the height of the pandemic.

In making their going concern assessment, the Directors also considered the strong demand currently being experienced, and that the pandemic has accelerated trends such as digitisation, near-shoring, and remote working, which the business is well-placed to benefit from. The assessment further considered the strong working capital position, with cash and bank deposit balances of £215m at 30 June 2021.

Based on this assessment, incorporating a review of the current position, the scenarios, principal risks and mitigation, the Directors have a reasonable expectation that the Group will be able to continue in operation and meet its liabilities as they fall due over the period to 31 October 2022. Accordingly, they continue to adopt the going concern basis in preparing these financial statements.

Basis of consolidation

Subsidiaries – subsidiaries are entities controlled by the Group. The Group controls an entity when it is exposed to or has rights to variable returns from its involvement with the entity and has the ability to affect those returns through its power over the entity. In assessing control, the Group takes into consideration potential voting rights that are exercisable. The acquisition date is the date on which control is transferred to the acquirer. The financial statements of subsidiaries are included in the consolidated financial statements from the date that control commences until the date that control ceases. Losses applicable to the non-controlling interests in a subsidiary are allocated to the non-controlling interests even if doing so causes the non-controlling interests to have a deficit balance.

Application of the equity method to associates and joint ventures – associates and joint ventures are accounted for using the equity method (equity-accounted investees) and are initially recognised at cost. The Group's investment includes goodwill identified on acquisition, net of any accumulated impairment losses.

The consolidated financial statements include the Group's share of the total comprehensive income and equity movements of equity accounted investees, from the date that significant influence commences until the date that significant influence ceases. When the Group's share of losses exceeds its interest in an equity accounted investee, the Group's carrying amount is reduced to nil and recognition of further losses is discontinued except to the extent that the Group has incurred legal obligations or made payments on behalf of an investee.

Transactions eliminated on consolidation – intragroup balances and transactions, and any unrealised income and expenses arising from intragroup transactions, are eliminated. Unrealised gains arising from transactions with equity accounted investees are eliminated against the investment to the extent of the Group's interest in the investee. Unrealised losses are eliminated in the same way as unrealised gains, but only to the extent that there is no evidence of impairment.

1. Accounting policies (continued)

Foreign currencies

Consolidation – overseas subsidiaries' results are translated into Sterling at weighted average exchange rates for the year by translating each overseas subsidiary's monthly results at exchange rates applicable to each of the respective months. Assets and liabilities denominated in foreign currencies at the balance sheet date are translated into Sterling at the foreign exchange rates prevailing at that date. Differences on exchange resulting from the translation of overseas assets and liabilities are recognised in Other comprehensive income and are accumulated in equity.

Transactions and balances – monetary assets and liabilities denominated in foreign currencies are reported at the rates prevailing at the time, with any gain or loss arising from subsequent exchange rate movements being included as an exchange gain or loss in the Consolidated income statement. Foreign currency differences arising from transactions are recognised in the Consolidated income statement.

Separately disclosed items

The Directors consider that certain items should be separately disclosed to aid understanding of the Group's performance.

Gains and losses from the fair value of financial instruments are therefore separately disclosed in the Consolidated income statement, where these gains and losses relate to certain forward currency contracts that are not effective for hedge accounting. Restructuring costs are also separately disclosed where significant costs have been incurred in rationalising and reorganising our business as part of a Board-approved initiative, and relate to matters that do not frequently recur.

These items are also excluded from Adjusted profit before tax, Adjusted operating profit and Adjusted earnings per share measures, as explained in note 28 Alternative performance measures.

Alternative performance measures

The financial statements are prepared in accordance with adopted IFRS and applied in accordance with the provisions of the Companies Act 2006. In measuring our performance, the financial measures that we use include those which have been derived from our reported results, to eliminate factors which distort year-on-year comparisons.

These are considered non-GAAP financial measures. We believe this information, along with comparable GAAP measurements, is useful to stakeholders in providing a basis for measuring our operational performance. The Board use these financial measures, along with the most directly comparable GAAP financial measures, in evaluating our performance (see note 28).

Revenue

The Group generates revenue from the sale of manufacturing technologies and analytical instruments and medical devices goods, capital equipment and services. These can be sold both on their own and together.

a) Sale of goods, capital equipment and services

The Group's contracts with customers consist both of contracts with one performance obligation and contracts with multiple performance obligations.

For contracts with one performance obligation, revenue is measured at the transaction price, which is typically the contract value except for customers entitled to volume rebates, and recognised at the point in time when control of the product transfers to the customer. This point in time is typically when the products are made available for collection by the customer, collected by the shipping agent, or delivered to the customer, depending upon the shipping terms applied to the specific contract.

Contracts with multiple performance obligations typically exist where, in addition to supplying product, we also supply services such as user training, servicing and maintenance, and installation services. Where the installation service is simple, does not include a significant integration service and could be performed by another party then the installation is accounted for as a separate performance obligation. Where the contracts include multiple performance obligations, the transaction price is allocated to each performance obligation based on the relative stand-alone selling prices. The revenue allocated to each performance obligation is then recognised when, or as, that performance obligation is satisfied. For installation, this is typically at the point in time in which installation is complete. For training, this is typically the point in time at which training is delivered. For servicing and maintenance, the revenue is recognised evenly over the course of the servicing agreement except for ad-hoc servicing and maintenance which is recognised at the point in time in which the work is undertaken.

b) Sale of software

The Group provides software licences and software maintenance to customers, sold both on their own and together with associated products. For software licences, where the licence and/or maintenance is provided as part of a contract that provides customers with software licences and other goods and services then the transaction price is allocated on the same basis as described in a) above.

The Group's distinct software licences provide a right of use, and therefore revenue from software licences is recognised at the point in time in which the licence is supplied to the customer. Revenue from software maintenance is recognised evenly over the term of the maintenance agreement.

Notes continued

1. Accounting policies (continued)

c) Extended warranties

The Group provides standard warranties to customers that address potential latent defects that existed at point of sale and as required by law (assurance-type warranties). In some contracts, the Group also provides warranties that extend beyond the standard warranty period and may be sold to the customer (service-type warranties).

Assurance-type warranties are accounted for by the Group under IAS 37 'Provisions, Contingent Liabilities and Contingent Assets'. Service-type warranties are accounted for as separate performance obligations and therefore a portion of the transaction price is allocated to this element, and then recognised evenly over the period in which the service is provided.

d) Contract balances

Contract assets represent the Group's right to consideration in exchange for goods and services that have been transferred to a customer, and mainly includes accrued revenue in respect of goods and services provided to a customer but not yet fully billed. Contract assets are distinct from receivables, which represent the Group's right to consideration that is unconditional.

Contract liabilities represent the Group's obligation to transfer goods or services to a customer for which the Group has either received consideration or consideration is due from the customer.

e) Disaggregation of revenue

The Group disaggregates revenue from contracts with customers between: goods, capital equipment and installation, and aftermarket services; reporting segment; and geographical location.

Management believe these categories best depict how the nature, amount, timing and uncertainty of the Group's revenue is affected by economic factors.

Financial instruments and fair value measurements

The Group measures financial instruments such as forward exchange contracts at fair value at each balance sheet date in accordance with IFRS 9 'Financial Instruments'. Fair value, as defined by IFRS 13 'Fair Value Measurement', is the price that would be received to sell an asset or paid to transfer a liability in an orderly transaction between market participants at the measurement date. Note 24, Financial instruments, provides detail on the IFRS 13 fair value hierarchy.

Trade and other current receivables are initially recognised at fair value and are subsequently held at amortised cost less any provision for bad and doubtful debts and expected credit losses according to IFRS 9. Loans to associates and joint ventures are initially recognised at fair value and are subsequently held at amortised cost. Trade and other current payables are initially recognised at fair value and are subsequently held at amortised cost.

Financial liabilities in the form of loans are initially recognised at fair value and are subsequently held at amortised cost. Financial liabilities are assessed for embedded derivatives and whether any such derivatives are closely related. If not closely related, such derivatives are accounted for at fair value in the Consolidated income statement.

Foreign currency derivative cash flow hedges

Foreign currency derivatives are used to manage risks arising from changes in foreign currency rates relating to overseas sales and foreign currency-denominated assets and liabilities. The Group does not enter into derivatives for speculative purposes. Foreign currency derivatives are stated at their fair value, being the estimated amount that the Group would pay or receive to terminate them at the balance sheet date, based on prevailing foreign currency rates.

Changes in the fair value of foreign currency derivatives which are designated and effective as hedges of future cash flows are recognised in Other comprehensive income and in the Cash flow hedging reserve, and subsequently transferred to the carrying amount of the hedged item or the Consolidated income statement. Realised gains or losses on cash flow hedges are therefore recognised in the Consolidated income statement within revenue in the same period as the hedged item.

Hedge accounting is discontinued when the hedging instrument expires or when the hedging instrument or hedged item no longer qualify for hedge accounting. If the forecast transaction is still expected to occur, but is no longer highly probable, the cumulative gain or loss in the cash flow hedge reserve remains in that reserve until the transaction occurs. If the forecast transaction is no longer expected to occur, the cumulative gain or loss in the cash flow hedge reserve is immediately reclassified to the Consolidated income statement.

Changes in fair value of foreign currency derivatives, which are ineffective or do not meet the criteria for hedge accounting in IFRS 9, are recognised in the Consolidated income statement within Gains/losses from the fair value of financial instruments.

In addition to derivatives held for cash flow hedging purposes, the Group uses short-term derivatives not designated as hedging instruments to offset gains and losses from exchange rate movements on foreign currency-denominated assets and liabilities. Gains and losses from currency movements on underlying assets and liabilities, realised gains and losses on these derivatives, and fair value gains and losses on outstanding derivatives of this nature are all recognised in Financial income and expenses in the Consolidated income statement. See note 24 for further detail on financial instruments.

1. Accounting policies (continued)

Key estimate – Estimates of highly probable forecasts of the hedged item

Derivatives are effective for hedge accounting to the extent that the hedged item is 'highly probable' to occur, with 'highly probable' indicating a much greater likelihood of occurrence than the term 'more likely than not'. Determining a highly probable sales forecast for Renishaw plc and Renishaw UK Sales Limited, being the hedged item, over a multiple year time period, requires judgement of the suitability of external and internal data sources and estimations of future sales. Relevant sensitivity analysis is included in note 24.

Cash and cash equivalents

Cash and cash equivalents comprise cash balances, and deposits with an original maturity of less than three months or with an original maturity date of more than three months where the deposit can be accessed on demand without significant penalty for early withdrawal and where the original deposit amount is recoverable in full.

Pension scheme cash escrow account

The Company holds a pension scheme escrow account as part of the security given for the UK defined benefit pension scheme. This account is shown within current assets in the Consolidated balance sheet as it may be used to settle pension scheme liabilities immediately upon enforcement of the charge over the account.

Goodwill and other intangible assets

Goodwill arising on acquisition represents the difference between the cost of the acquisition and the fair value of the net identifiable assets acquired, net of deferred tax. Identifiable intangibles are those which can be sold separately or which arise from legal rights regardless of whether those rights are separable.

Business combinations are accounted for using the acquisition method as at the acquisition date, which is the date on which control is transferred to the Group.

Goodwill is stated at cost less any accumulated impairment losses. It is not amortised but is tested annually for impairment or earlier if there are any indications of impairment. The annual impairment review involves comparing the carrying amount to the estimated recoverable amount and recognising an impairment loss if the recoverable amount is lower. Impairment losses are recognised in the Consolidated income statement.

Intangible assets such as customer lists, patents, trade marks, know-how and intellectual property that are acquired by the Group are stated at cost less amortisation and impairment losses. Amortisation is charged to the Consolidated income statement on a straight-line basis over the estimated useful lives of the intangible assets. The estimated useful lives of the intangible assets included in the Consolidated balance sheet reflect the benefit derived by the Group and vary from five to 10 years.

Intangible assets – research and development costs

Expenditure on research activities is recognised in the Consolidated income statement as an expense as incurred. Expenditure on development activities is capitalised if the product or process is technically and commercially feasible and the Group intends and has the technical ability and sufficient resources to complete development, future economic benefits are probable, and the Group can measure reliably the expenditure attributable to the intangible asset during its development.

Development activities involve a plan or design for the production of new or substantially improved products or processes. The expenditure capitalised includes the cost of materials, direct labour and an appropriate proportion of overheads. Other development expenditure is recognised in the Consolidated income statement as an expense as incurred.

Capitalised development expenditure is amortised over five years and is stated at cost less accumulated amortisation and less accumulated impairment losses. Capitalised development expenditure is removed from the balance sheet 10 years after being fully amortised.

Key judgement – Whether a project meets the criteria for capitalisation

Product development costs are capitalised once a project has reached a certain stage of development and these costs are subsequently amortised over a five-year period. Costs are capitalised from the point the product has passed testing to demonstrate it meets the technical specifications of the project and it satisfies all applicable regulations. Judgements are required to assess whether the new product development has reached the appropriate point for capitalisation of costs to begin. Should a product be subsequently obsoleted, the accumulated capitalised development costs would need to be immediately written off in the Consolidated income statement.

Intangible assets – software licences

Intangible assets, comprising software licences that are acquired by the Group, are stated at cost less accumulated amortisation and impairment losses. Amortisation is charged on a straight-line basis over the estimated useful life of the assets. The useful life of each of these assets is assessed on an individual basis and they range from two to 10 years.

Notes continued

1. Accounting policies (continued)

Impairment of non-current assets

All non-current assets are tested for impairment whenever there is an indication that their carrying value may be impaired. An impairment loss is recognised in the Consolidated income statement to the extent that an asset's carrying value exceeds its recoverable amount, which represents the higher of the asset's net realisable value and its value-in-use. An asset's value-in-use represents the present value of the future cash flows expected to be derived from the asset or from the cash-generating unit to which it relates. The present value is calculated using a discount rate that reflects the current market assessment of the time value of money and the risks specific to the asset concerned.

Goodwill and capitalised development costs are subject to an annual impairment test.

Key estimate – Estimates of future cash flows used for impairment testing

Determining whether goodwill is impaired requires an estimation of the value-in-use of cash-generating units (CGUs) to which goodwill has been allocated. The value-in-use calculation involves an estimation of the future cash flows of CGUs and also the selection of appropriate discount rates, which involves judgement, to calculate present values (see note 12). Similarly, determining whether capitalised development costs are impaired requires an estimation of their value-in-use which involves significant judgement. Relevant sensitivity analysis is included in note 12.

Property, plant and equipment

Freehold land is not depreciated. Other assets are stated at cost less accumulated depreciation. Depreciation is provided to write off the cost of assets less their estimated residual value on a straight-line basis over their estimated useful economic lives as follows:

- freehold buildings, 50 years;
- plant and equipment, 3 to 25 years; and
- vehicles, 3 to 4 years.

Inventory and work in progress

Inventory and work in progress is valued at the lower of actual cost on a first-in, first-out (FIFO) basis and net realisable value. In respect of work in progress and finished goods, cost includes all production overheads and the attributable proportion of indirect overhead expenses that are required to bring inventories to their present location and condition. Overheads are absorbed into inventories on the basis of normal capacity or on actual hours if higher.

Key estimate – Determination of net realisable inventory value

Determining the net realisable value of inventory requires management to estimate future demand, especially in respect of provisioning for slow moving and potentially obsolete inventory. When calculating an inventory provision, management use historic usage levels (capped at 18 months), demand from customer orders and manufacturing build plans as a basis for estimating the future annual demand of individual stock items, except in the following instances:

- for key products and their components, provisions are typically made for quantities held in excess of three years' demand. A demand basis lower than three years is used for those key products and related components where the sales history is more volatile; and
- where strategic purchases of critical components have been made, an outlook beyond three years is considered where appropriate.

Leases

As a lessee

At the lease commencement date the Group recognises a right-of-use asset for the leased item and a lease liability for any lease payments due.

Right-of-use assets are initially measured at cost, being the present value of the lease liability plus any initial costs incurred in entering the lease and less any lease incentives received. Right-of-use assets are subsequently depreciated on a straight-line basis from the commencement date to the earlier of i) the end of the useful life of the asset, or ii) the end of the lease term.

Lease liabilities are initially measured at the present value of the lease payments that are not paid at the commencement date, discounted using the incremental borrowing rate of the applicable entity. The lease liability is subsequently measured at amortised cost using the effective interest method and is remeasured if there is a change in future lease payments arising from a change in an index or rate (such as an inflation-linked increase), or if there is a change in the Group's assessment of whether it will exercise an extension or termination option. When this happens there is also a corresponding adjustment to the right-of-use asset.

Where the Group enters into leases with a lease term of 12 months or less, these are treated as 'short-term' leases and are recognised on a straight-line basis as an expense in the Consolidated income statement. The same treatment applies to low-value assets, which are typically IT equipment and office equipment.

1. Accounting policies (continued)

As a lessor

The Group acts as a lessor for Renishaw-manufactured plant and equipment and determines at inception whether the lease is a finance lease or an operating lease.

Where the Group transfers the risks and rewards of ownership of lease assets to a third party, the Group recognises a receivable in the amount of the net investment in the lease. The lease receivable is subsequently reduced by the principal received, while an interest component is recognised as financial income in the Consolidated income statement.

Where the Group retains the risks and rewards of ownership of lease assets, it continues to recognise the leased asset in Property, plant and equipment. Income from operating leases is recognised on a straight-line basis over the lease term and recognised as Revenue rather than Other revenue as such income is not material.

Employee benefits

The Group operates contributory pension schemes, largely for UK, Ireland and USA employees, which were of the defined benefit type up to 5 April 2007, 31 December 2007 and 30 June 2012 respectively, at which time they ceased any future accrual for existing members and were closed to new members.

The schemes are administered by trustees who are independent of the Group finances. Investment assets of the defined benefit schemes are measured at fair value using the bid price of the unitised investments, quoted by the investment manager, at the reporting date. Pension scheme liabilities are measured using a projected unit method and discounted at the current rate of return on a high-quality corporate bond of equivalent term and currency to the liability. Remeasurements arising from defined benefit schemes comprise actuarial gains and losses, the return on scheme assets (excluding interest) and the effect of the asset ceiling (if any, excluding interest). The Company recognises them immediately in Other comprehensive income and all other expenses related to defined benefit schemes are included in the Consolidated income statement.

The pension schemes' surpluses, to the extent that they are considered recoverable, or deficits are recognised in full and presented on the face of the Consolidated balance sheet under Employee benefits. Where a guarantee is in place in relation to a pension scheme deficit, liabilities are reported in accordance with IFRIC 14 'The Limit on a Defined Benefit Asset, Minimum Funding Requirements and their Interaction'. To the extent that contributions payable will not be available as a refund after they are paid into the plan, a liability is recognised at the point the obligation arises, which is the point at which the minimum funding guarantee is agreed. Overseas-based employees are covered by state, defined benefit and private pension schemes in their countries of residence. Actuarial valuations of overseas pension schemes were not obtained, apart from Ireland and USA, because of the low number of members. For defined contribution schemes, the amount charged to the Consolidated income statement represents the contributions payable to the schemes in respect of the accounting period.

Accruals are made for holiday pay, based on a calculation of the number of days holiday earned during the year but not yet taken, and also for performance bonuses, if applicable.

Key estimate – Valuation of defined benefit pension schemes' liabilities

Determining the value of the future defined benefit obligation requires estimation in respect of the assumptions used to determine the present values. These include future mortality, discount rate and inflation. Management makes these estimates in consultation with independent actuaries. Details of the estimates in respect of the current year are given in note 22. Based on a review of the terms of the UK scheme trust deed, management has concluded that there are no likely circumstances which would result in the Company having an unconditional right to a refund in the event of a fund surplus. Relevant sensitivity analysis is included in note 22.

Share-based payments

The Group provides share-based payment arrangements to certain employees in accordance with the Renishaw plc deferred annual equity incentive plan (the Plan) (see the Governance section for further detail). The share awards are subject only to continuing service of the employee and are equity settled. The fair value of the awards at the date of grant, which is estimated to be equal to the market value, is charged to the Consolidated income statement on a straight-line basis over a three-year vesting period, with appropriate adjustments made to reflect expected or actual forfeitures. The corresponding credit is to Other reserve. The Renishaw Employee Benefit Trust (EBT) is responsible for purchasing shares on the open market on behalf of the Company to satisfy the Plan awards. Own shares held are recognised as an element in equity until they are transferred at the end of the vesting period, and such shares are excluded from earnings per share calculations.

Warranty provisions

The Group provides a warranty from the date of purchase, except for those products that are installed by the Group where the warranty starts from the date of completion of the installation. This is typically for a 12-month period, although up to three years is given for a small number of products. A warranty provision is included in the Group financial statements, which is calculated on the basis of historical returns and internal quality reports.

Notes continued

1. Accounting policies (continued)

Government grants

Government grants are recognised in the Consolidated income statement as a deduction against expenditure. Where grants are received in advance of the related expenses, they are initially recognised in the Consolidated balance sheet and released to match the related expenditure. Where grants are expected to be received after the related expenditure has occurred, and there is reasonable assurance that the entity will comply with the grant conditions, amounts are recognised to offset the expenditure and an asset recognised.

Taxation

Tax on the profit for the year comprises current and deferred tax. Tax is recognised in the Consolidated income statement except to the extent that it relates to items recognised directly in Other comprehensive income, in which case it is recognised in the Consolidated statement of comprehensive income and expense. Current tax is the expected tax payable on the taxable income for the year, using tax rates enacted or substantively enacted at the balance sheet date, and any adjustment to tax payable in previous years.

Deferred tax is provided on temporary differences between the carrying amounts of assets and liabilities for financial reporting purposes and the amounts used for taxation purposes. The following temporary differences are not provided for: the initial recognition of goodwill; the initial recognition of assets or liabilities that affect neither accounting nor taxable profit other than in a business combination; and differences relating to investments in subsidiaries, to the extent that they will probably not reverse in the foreseeable future. The amount of deferred tax provided is based on the expected manner of realisation or settlement of the carrying amount of assets and liabilities, using tax rates enacted or substantively enacted at the balance sheet date.

Key estimate – Estimates of future profits to support the recognition of deferred tax assets

Deferred tax assets are recognised to the extent it is probable that future taxable profits (including the future release of deferred tax liabilities) will be available, against which the deductible temporary differences can be used, based on management's assumptions relating to the amounts and timing of future taxable profits. Estimates of future profitability on an entity basis are required to ascertain whether it is probable that sufficient taxable profits will arise to support the recognition of deferred tax assets relating to the corresponding entity. Relevant sensitivity analysis is included in note 9.

2. Segmental analysis

The Group manages its business in two segments, comprising manufacturing technologies (previously metrology) and analytical instruments and medical devices (previously healthcare). Within the operating segments there are multiple product offerings with similar economic characteristics, similar production processes and similar customer bases. The results of these two segments are regularly reviewed by the Board to allocate resources and to assess their performance.

During the year, we used the launch of our purpose, vision and strategy to rename our operating segments to better reflect the business. Our Manufacturing technologies business consists of industrial metrology, position measurement and additive manufacturing (AM) product lines, while our Analytical instruments and medical devices business consists of spectroscopy, neurological and medical dental product lines.

More details of the Group's products and services are given in the Strategic Report.

	Manufacturing technologies £'000	Analytical instruments and medical devices £'000	Total £'000
Year ended 30 June 2021			
Revenue	526,191	39,368	565,559
Depreciation, amortisation and impairment	36,916	3,180	40,096
Operating profit before gains from fair value of financial instruments	110,498	5,865	116,363
Share of profits from associates and joint ventures	1,683	–	1,683
Net financial expense	–	–	(585)
Gains from the fair value of financial instruments	–	–	21,978
Profit before tax	–	–	139,439

2. Segmental analysis (continued)

Year ended 30 June 2020	Manufacturing technologies £'000	Analytical instruments and medical devices £'000	Total £'000
Revenue	475,203	35,012	510,215
Depreciation, amortisation and impairment	62,591	2,557	65,148
Operating profit before losses from fair value of financial instruments	31,188	1,737	32,925
Share of profits from associates and joint ventures	841	–	841
Net financial expense	–	–	(3,927)
Losses from the fair value of financial instruments	–	–	(26,631)
Profit before tax	–	–	3,208

There is no allocation of assets and liabilities to operating segments. Depreciation is included within certain other overhead expenditure which is allocated to segments on the basis of the level of activity.

The following table shows the disaggregation of Group revenue by category:

	2021 £'000	2020 £'000
Goods, capital equipment and installation	513,675	457,024
Aftermarket services	51,884	53,191
Total Group revenue	565,559	510,215

Aftermarket services include repairs, maintenance and servicing, programming, training, extended warranties, and software licences and maintenance. There is no significant difference between our two operating segments as to their split of revenue by type.

The analysis of revenue by geographical market was:

	2021 £'000	2020 £'000
APAC total	274,765	227,650
UK (country of domicile)	26,923	27,478
EMEA, excluding UK	142,219	139,775
EMEA total	169,142	167,253
Americas total	121,652	115,312
Total Group revenue	565,559	510,215

Revenue in the previous table has been allocated to regions based on the geographical location of the customer. Countries with individually material revenue figures in the context of the Group were:

	2021 £'000	2020 £'000
China	141,690	102,840
USA	103,850	101,153
Japan	51,523	57,833
Germany	51,095	49,397

There was no revenue from transactions with a single external customer which amounted to more than 10% of the Group's total revenue.

The following table shows the analysis of non-current assets, excluding deferred tax and derivatives, by geographical region:

	2021 £'000	2020 £'000
UK	179,039	186,249
Overseas	146,393	159,258
Total non-current assets	325,432	345,507

No overseas country had non-current assets amounting to 10% or more of the Group's total non-current assets.

Notes continued

3. Personnel expenses

The aggregate payroll costs for the year were:

	2021 £'000	2020 £'000
Wages and salaries	183,235	183,165
Compulsory social security contributions	21,766	21,373
Contributions to defined contribution pension schemes	19,759	21,103
Government grants – employment support	(989)	(4,532)
Share-based payment charge	173	173
Total payroll costs	223,944	221,282

Wages and salaries and compulsory social security contributions include £13,208,000 (2020: £nil) relating to performance bonuses and £3,500,000 (2020: £nil) relating to a one-off 'thank you' payment.

Amounts recognised as 'Government grants - employment support' relate to non-UK schemes in 2021 and mostly related to the UK Coronavirus Job Retention Scheme in 2020. The 2021 net amount of £989,000 includes £1,900,000 that was received in the year in relation to the UK Coronavirus Job Retention Scheme, and repaid in the same period.

The average number of persons employed by the Group during the year was:

	2021 Number	2020 Number
UK	2,742	3,001
Overseas	1,695	1,796
Average number of employees	4,437	4,797

Key management personnel have been assessed to be the Directors of the Company.

The total remuneration of the Directors was:

	2021 £'000	2020 £'000
Short-term employee benefits	2,697	1,980
Post-employment benefits	111	136
Share-based payment charge	173	173
Total remuneration of the Directors	2,981	2,289

Full details of Directors' remuneration are given in the Directors' Remuneration Report.

4. Cost of sales

Included in cost of sales are the following amounts:

	2021 £'000	2020 £'000
Production costs	197,805	184,326
Research and development expenditure	58,618	66,614
Other engineering expenditure	18,019	15,755
Gross engineering expenditure	76,637	82,369
Development expenditure capitalised (net of amortisation)	(825)	(544)
Development expenditure impaired (see note 12)	1,092	9,881
Research and development tax credit	(4,857)	(4,399)
Total engineering costs	72,047	87,307
Total cost of sales	269,852	271,633

Research and development expenditure includes the payroll costs, material costs and allocated overheads attributed to projects identified as being related to new products or processes. Other engineering expenditure includes the payroll costs, material costs and allocated overheads attributed to projects identified as being related to existing products or processes.

Development expenditure impaired in 2020 excluded amounts relating to Restructuring costs in that period.

5. Financial income and expenses

	2021 £'000	2020 £'000
Financial income		
Fair value gains from one-month forward currency contracts (note 24)	2,781	–
Bank interest receivable	625	913
Total financial income	3,406	913
Financial expenses		
Net interest on pension schemes' liabilities (note 22)	876	861
Currency losses	2,660	2,433
Fair value losses from one-month forward currency contracts (note 24)	–	154
Lease interest	335	765
Interest payable on borrowings	69	78
Other interest payable	51	549
Total financial expenses	3,991	4,840

Currency losses relate to revaluations of foreign currency-denominated balances using latest reporting currency exchange rates. The losses recognised in 2021 largely related to an appreciation of Sterling relative to the US dollar affecting US dollar-denominated intragroup balances in the Company.

Certain intragroup balances are classified as 'net investments in foreign operations', such that revaluations from currency movements on designated balances accumulate in the Currency translation reserve in Equity. Rolling one-month forward currency contracts are used to offset currency movements on remaining intragroup balances, with fair value gains and losses being recognised in financial income or expenses. See note 24 for further details.

6. Profit before tax

Included in the profit before tax are the following costs:

	notes	2021 £'000	2020 £'000
Depreciation and impairment of property, plant and equipment and right-of-use assets	(a)	28,780	33,168
Loss on sale of property, plant and equipment	(a)	31	22
Amortisation and impairment of intangible assets	(a)	11,316	36,716
Impairment of investment in associates and joint ventures	(b)	1,674	257
Impairment of long-term loans to associates and joint ventures	(b)	2,633	1,297
Auditor:			
Audit of these financial statements	(b)	403	293
Audit of subsidiary undertakings pursuant to legislation	(b)	458	398
Other assurance	(b)	12	12
All other non-audit fees	(b)	–	3

These costs can be found under the following headings in the Consolidated income statement: (a) within cost of sales, distribution costs and administrative expenses and (b) within administrative expenses.

7. Earnings per share

Basic and diluted earnings per share are calculated on earnings of £111,459,000 (2020: £288,000) and on 72,778,904 shares (2020: 72,778,904 shares), being the number of shares in issue. The number of shares excludes 9,639 shares held by the EBT, which were purchased on 10 December 2018.

There is no difference between the weighted average earnings per share and the basic and diluted earnings per share.

For the calculation of adjusted earnings per share, per note 28, earnings of £111,459,000 (2020: £288,000) are adjusted by post-tax amounts for Fair value (gains)/losses on financial instruments not eligible for hedge accounting (reported in Revenue), Fair value (gains)/losses on financial instruments not eligible for hedge accounting (reported in Gains/(losses) from the fair value of financial instruments) and costs relating to the formal sales process, amounting to £825,000 gain, £17,802,000 gain and £3,222,000 loss respectively.

Notes continued

8. Income tax expense

	2021 £'000	2020 £'000
Current tax:		
UK corporation tax on profits for the year	7,535	–
UK corporation tax – prior year adjustments	(4,376)	333
Overseas tax on profits for the year	13,237	9,236
Overseas tax – prior year adjustments	27	(89)
Total current tax	16,423	9,480
Deferred tax:		
Origination and reversal of temporary differences	7,692	(9,349)
Prior year adjustments	4,438	(185)
Derecognition of previously recognised tax losses and excess interest	–	2,953
Recognition of previously unrecognised tax losses and excess interest	(3,909)	(1,127)
Effect on deferred tax for changes in tax rates	3,336	1,148
	11,557	(6,560)
Tax charge on profit	27,980	2,920

Prior year adjustments mainly relate to the carry back of losses, with a current tax credit offset by a deferred tax charge.

The tax for the year is higher (2020: higher) than the UK standard rate of corporation tax of 19% (2020: 19%). The differences are explained as follows:

	2021 £'000	2020 £'000
Profit before tax	139,439	3,208
Tax at 19% (2020: 19%)	26,493	610
Effects of:		
Different tax rates applicable in overseas subsidiaries	(150)	(312)
Expenses not deductible for tax purposes	1,817	576
Companies with unrelieved tax losses	100	189
Share of profits of associates and joint ventures	(320)	(85)
Items with no tax effect	(386)	(596)
Prior year adjustments	89	58
Effect on deferred tax for changes in tax rates	3,336	1,148
Recognition of previously unrecognised tax losses and excess interest	(3,909)	(1,127)
Derecognition of previously recognised tax losses and excess interest	–	2,953
Use of unrecognised losses	(162)	(399)
Irrecoverable withholding tax	1,052	–
Other differences	20	(95)
Tax charge on profit	27,980	2,920
Effective tax rate	20.1%	91.0%

The Group's future effective tax rate (ETR) will mainly depend on the geographic mix of profits and whether there are any changes to tax legislation in the Group's most significant countries of operations. In the Spring Budget 2021, the UK Government announced that from 1 April 2023 the UK corporation tax rate will increase to 25%, rather than remaining at 19%, which has resulted in a deferred tax charge of £3,336,000. This has been more than offset by the recognition of deferred tax assets totalling £3,909,000, which has mostly arisen from increased confidence over the recoverability of a portion of previously unrecognised losses and excess interest against future taxable profits in our US business. The increased confidence arises from a recovery in trading conditions and cost reductions following restructuring activities in 2020 (see note 29).

9. Deferred tax

Deferred tax assets and liabilities are offset where there is a legally enforceable right of offset and there is an intention to net settle the balances. After taking these offsets into account, the net position of £10,890,000 asset (2020: £39,142,000 asset) is presented as a £21,292,000 deferred tax asset (2020: £39,641,000 asset) and a £10,402,000 deferred tax liability (2020: £499,000 liability) in the Consolidated balance sheet. Where deferred tax assets are recognised, the Directors are of the opinion, based on recent and forecast trading, that the level of profits in current and future years make it more likely than not that these assets will be recovered.

It is likely that the majority of unremitted earnings of overseas subsidiaries would qualify for the UK dividend exemption. However, £43,858,000 of those earnings may still result in a tax liability principally as a result of withholding taxes levied by the overseas jurisdictions in which those subsidiaries operate. The tax liabilities for the earnings for which management intend to repatriate in the foreseeable future are not material and consequently no deferred tax liability has been recognised.

9. Deferred tax (continued)

Balances at the end of the year were:

	2021			2020		
	Assets £'000	Liabilities £'000	Net £'000	Assets £'000	Liabilities £'000	Net £'000
Property, plant and equipment	425	(17,546)	(17,121)	306	(14,234)	(13,928)
Intangible assets	–	(2,609)	(2,609)	–	(1,264)	(1,264)
Intragroup trading (inventories)	14,539	–	14,539	14,249	(289)	13,960
Intragroup trading (fixed assets)	1,252	–	1,252	2,071	–	2,071
Defined benefit pension schemes	4,548	(201)	4,347	11,951	(55)	11,896
Derivatives	–	(2,930)	(2,930)	6,344	–	6,344
Tax losses	8,365	–	8,365	14,077	–	14,077
Other	5,083	(36)	5,047	6,023	(37)	5,986
Balance at the end of the year	34,212	(23,322)	10,890	55,021	(15,879)	39,142

Other deferred tax assets include timing differences relating to inventory provisions totalling £2,001,000 (2020: £1,876,000), other provisions (including bad debt provisions) of £683,000 (2020: £1,628,000), employee benefits relating to Renishaw KK of £668,000 (2020: £731,000), and uniform capitalisation relating to Renishaw, Inc. of £117,000 (2020: £729,000), with the remaining balance relating to a number of other temporary differences.

The movements in the deferred tax balance during the year were:

	2021 £'000	2020 £'000
Balance at the beginning of the year	39,142	29,316
Reallocation from current tax	–	163
Movements in the Consolidated income statement	(11,557)	6,560
Movement in relation to the cash flow hedging reserve	(9,790)	(1,978)
Movement in relation to the currency translation reserve	902	(403)
Movement in relation to the defined benefit pension scheme liabilities	(7,705)	5,484
Total movement in the Consolidated statement of comprehensive income and expense	(16,593)	3,103
Currency translation	(102)	–
Balance at the end of the year	10,890	39,142

The deferred tax movement in the Consolidated income statement is analysed as:

	2021 £'000	2020 £'000
Property, plant and equipment	(3,193)	(847)
Intangible assets	(1,345)	1,230
Intragroup trading (inventories)	579	(2,725)
Intragroup trading (fixed assets)	(819)	(238)
Defined benefit pension schemes	156	(2,114)
Derivatives	(2,185)	(494)
Tax losses	(5,712)	10,822
Other	962	926
Total movement for the year	(11,557)	6,560

The Company has partially used the tax losses incurred in 2020 by way of loss carry back and offset against 2021 profits, reducing the deferred tax asset in respect of losses from £11,225,000 at 30 June 2020 to £3,299,000 at 30 June 2021. It is considered likely that the Company will generate sufficient future taxable profits to recognise the remaining deferred tax asset in full, as losses made in 2020 included a number of costs such as restructuring costs per note 29, which are unlikely to reoccur in future years, while the Company reported a profit before tax of £54,771,000 in 2021 (excluding intragroup dividends received). Further deferred tax assets of £5,066,000 in respect of losses are recognised across other Group companies where it is considered likely that the business will generate sufficient future taxable profits.

Deferred tax assets have not been recognised in respect of tax losses carried forward of £4,459,000 (2020: £20,930,000), due to uncertainty over their offset against future taxable profits and therefore their recoverability. These losses are held by Group companies in Switzerland, Brazil and Australia. Losses in Switzerland (46%) expire by 2023, while there are no time limitations to the remainder.

In determining profit forecasts for each Group company, revenue forecasts have been estimated using consistently applied external and internal data sources, which is the key variable in the profit forecasts. Sensitivity analysis indicates that a reduction of 5% to relevant revenue forecasts would result in an impairment to deferred tax assets recognised in respect of losses and intragroup trading (inventories) of less than £300,000, while an increase of 5% would result in additions to deferred tax assets in respect of tax losses not recognised of less than £100,000.

Notes continued

10. Property, plant and equipment

Year ended 30 June 2021	Freehold land and buildings £'000	Plant and equipment £'000	Motor vehicles £'000	Assets in the course of construction £'000	Total £'000
Cost					
At 1 July 2020	225,556	247,986	8,526	6,363	488,431
Additions	194	6,930	143	3,606	10,873
Transfers	345	2,515	–	(2,860)	–
Disposals	(136)	(9,628)	(951)	–	(10,715)
Currency adjustment	(9,176)	(5,371)	(297)	–	(14,844)
At 30 June 2021	216,783	242,432	7,421	7,109	473,745
Depreciation					
At 1 July 2020	35,842	175,864	6,676	–	218,382
Charge for the year	4,084	19,407	826	–	24,317
Disposals	(124)	(9,658)	(858)	–	(10,640)
Currency adjustment	(1,272)	(3,056)	(228)	–	(4,556)
At 30 June 2021	38,530	182,557	6,416	–	227,503
Net book value					
At 30 June 2021	178,253	59,875	1,005	7,109	246,242
At 30 June 2020	189,714	72,122	1,850	6,363	270,049

At 30 June 2021, properties with a net book value of £81,679,000 (2020: £83,200,000) were subject to a fixed charge to secure the UK defined benefit pension scheme liabilities.

Additions to assets in the course of construction comprise £817,000 (2020: £12,836,000) for land and buildings and £2,789,000 (2020: £5,886,000) for plant and equipment.

Year ended 30 June 2020	Freehold land and buildings £'000	Plant and equipment £'000	Motor vehicles £'000	Assets in the course of construction £'000	Total £'000
Cost					
At 1 July 2019	197,474	245,027	9,555	8,758	460,814
Additions	11,808	7,818	309	18,722	38,657
Transfers	15,948	5,169	–	(21,117)	–
Disposals	(297)	(10,061)	(1,305)	–	(11,663)
Currency adjustment	623	33	(33)	–	623
At 30 June 2020	225,556	247,986	8,526	6,363	488,431
Depreciation					
At 1 July 2019	31,893	158,567	6,877	–	197,337
Charge for the year	3,985	20,796	1,061	–	25,842
Impairment	–	2,590	–	–	2,590
Disposals	(386)	(6,389)	(1,235)	–	(8,010)
Currency adjustment	350	300	(27)	–	623
At 30 June 2020	35,842	175,864	6,676	–	218,382
Net book value					
At 30 June 2020	189,714	72,122	1,850	6,363	270,049
At 30 June 2019	165,581	86,460	2,678	8,758	263,477

11. Right-of-use assets

Year ended 30 June 2021	Leasehold property £'000	Plant and equipment £'000	Motor vehicles £'000	Total £'000
Net book value				
At 1 July 2020	10,287	–	2,385	12,672
Additions	3,548	232	1,234	5,014
Depreciation	(2,903)	(121)	(1,439)	(4,463)
Currency adjustment	(635)	(9)	(150)	(794)
At 30 June 2021	10,297	102	2,030	12,429

12. Intangible assets

Year ended 30 June 2021	Goodwill £'000	Other intangible assets £'000	Internally generated development costs £'000	Software licences and intellectual property £'000	Total £'000
Cost					
At 1 July 2020	20,518	15,829	167,447	22,063	225,857
Additions	–	–	9,844	3,000	12,844
Currency adjustment	(985)	(46)	–	(101)	(1,132)
At 30 June 2021	19,533	15,783	177,291	24,962	237,569
Amortisation					
At 1 July 2020	9,028	13,105	141,696	18,664	182,493
Charge for the year	–	101	9,019	1,104	10,224
Impairment	–	–	1,092	–	1,092
Currency adjustment	–	48	–	(83)	(35)
At 30 June 2021	9,028	13,254	151,807	19,685	193,774
Net book value					
At 30 June 2021	10,505	2,529	25,484	5,277	43,795
At 30 June 2020	11,490	2,724	25,751	3,399	43,364
Year ended 30 June 2020	Goodwill £'000	Other intangible assets £'000	Internally generated development costs £'000	Software licences and intellectual property £'000	Total £'000
Cost					
At 1 July 2019	20,227	13,823	150,042	20,827	204,919
Additions	–	1,986	17,405	1,352	20,743
Disposals	–	–	–	(140)	(140)
Currency adjustment	291	20	–	24	335
At 30 June 2020	20,518	15,829	167,447	22,063	225,857
Amortisation					
At 1 July 2019	8,220	11,260	108,954	17,429	145,863
Charge for the year	–	267	16,861	1,299	18,427
Impairment	808	1,600	15,881	–	18,289
Disposals	–	–	–	(87)	(87)
Currency adjustment	–	(22)	–	23	1
At 30 June 2020	9,028	13,105	141,696	18,664	182,493
Net book value					
At 30 June 2020	11,490	2,724	25,751	3,399	43,364
At 30 June 2019	12,007	2,563	41,088	3,398	59,056

Goodwill

Goodwill has arisen on the acquisition of a number of businesses and has an indeterminable useful life. It is therefore not amortised but is instead tested for impairment annually and at any point during the year when an indicator of impairment exists. Goodwill is allocated to cash generating units (CGUs), which are either the statutory entities acquired or the group-wide product line. This is the lowest level in the Group at which goodwill is monitored for impairment and is at a lower level than the Group's operating segments.

The analysis of goodwill is:

	2021 £'000	2020 £'000
itp GmbH	2,959	3,148
Renishaw Mayfield S.A.	1,873	2,039
Renishaw Fixturing Solutions, LLC	5,018	5,585
Other smaller acquisitions	655	718
Total goodwill	10,505	11,490

The recoverable amounts of acquired goodwill are based on value-in-use calculations. These calculations use cash flow projections based on either the financial business plans approved by management for the next five financial years, or estimated growth rates over the five years, which are set out on page 128. The cash flows beyond this forecast are extrapolated to perpetuity using a nil growth rate on a prudent basis, to reflect the uncertainties over forecasting beyond five years.

Notes continued

12. Intangible assets (continued)

The following pre-tax discount rates have been used in discounting the projected cash flows:

Business acquired	CGU	2021 Discount rate	2020 Discount rate
itp GmbH	itp GmbH entity ('ITP')	10.6%	10.6%
Renishaw Fixturing Solutions, LLC	Renishaw fixturing product line ('RFS')	10.2%	10.2%
Renishaw Mayfield S.A.	Renishaw Mayfield S.A. entity ('Mayfield')	21.4%	21.4%

The Group post-tax weighted average cost of capital, calculated at 30 June 2021, is 8% (2020: 8%). Pre-tax discount rates for Manufacturing technologies CGUs (ITP and RFS) are calculated from this basis, given that they are aligned with the wider Group's industries, markets and processes. The Analytical instruments and medical devices CGU (Mayfield) has a higher risk weighting, reflecting the less mature nature of this segment. This risk weighting is unchanged from 2020.

An increase of 5% in the discount rates would result in an impairment of around £2m in the RFS CGU. For there to be an impairment in the ITP or Mayfield CGUs the discount rate would need to increase to at least 42% and 98% respectively. Management deems the likelihood of these increases to be unlikely.

The following bases have been used in determining cash flow projections:

CGU	2021 Basis of forecast	2020 Basis of forecast
itp GmbH entity	five-year business plan	5% growth rate
Renishaw fixturing product line	five-year business plan	five-year business plan
Renishaw Mayfield S.A. entity	five-year business plan	five-year business plan

These five-year business plans are considered prudent estimates based on management's view of the future and experience of past performance of the individual CGUs, and are calculated at a disaggregated level. Within these plans, revenue forecasts are calculated with reference to external market data, Renishaw past outperformance, and new product launches, consistent with revenue forecasts across the Group. Production costs, engineering costs, distribution costs and administrative expenses are calculated based on management's best estimates of what is required to support revenue growth and new product development. Estimates of capital expenditure and working capital requirements are also included in the cash flow projections.

The key estimate within these business plans is the forecasting of revenue growth, given that the cost bases of the businesses can be flexed in line with revenue performance. Given the average revenue growth assumptions included in the five-year business plans, management's sensitivity analysis involves modelling a reduction in the forecast cash flows utilised in those business plans and therefore into perpetuity. For there to be an impairment there would need to be a reduction to these forecast cash flows of 80% for ITP, 10% for RFS and 83% for Mayfield. Management deems the likelihood of these reductions to be unlikely.

Internally generated development costs

The key assumption in determining the value-in-use for internally generated development costs is the forecast unit sales over five years, which is determined by management using their knowledge and experience with similar products and the sales history of products already available in the market. Resulting cash flow projections over five years, the period over which product demand forecasts can be reasonably predicted and internally generated development costs are written off, are discounted using pre-tax discount rates, which are calculated from the Group post-tax weighted average cost of capital of 8% (2020: 8%).

Impairments of internally generated development costs in the year totalled £1,092,000 (2020: £15,881,000), resulting from an increase in the forecast of ongoing support costs of one project. This was accounted for in Cost of sales in the Consolidated income statement and relates to the Manufacturing technologies segment.

For the largest projects, comprising over 95% of the net book value at 30 June 2021, a 10% reduction to forecast unit sales, or an increase in the discount rate by 5%, would result in a further impairment of less than £500,000.

13. Investments in associates and joint ventures

The Group's investments in associates and joint ventures (all investments being in the ordinary share capital of the associate and joint ventures), whose accounting years end on 30 June, except where noted otherwise, were:

	Country of incorporation and principal place of business	Ownership % 2021	Ownership % 2020
RLS Merilna tehnika d.o.o. ('RLS') – joint venture	Slovenia	50.0	50.0
Metrology Software Products Limited ('MSP') – joint venture	England & Wales	70.0	50.0
HiETA Technologies Limited ('HiETA') (31 December) – associate	England & Wales	33.3	33.3

For the nature of the activities, see note C.45.

On 28 June 2021 Renishaw acquired an additional 20% shareholding in MSP, a pre-existing joint venture company, with cash consideration of £749,000. Following the transaction, the Group owns 70% of the ordinary share capital of MSP, and continues to equity account for MSP as a joint venture as the 'control' requirements of IFRS 10 are not satisfied. This is primarily because under the terms of the pre-existing and unchanged shareholders agreement, dated 8 September 2005, for so long as the Group's holding is less than 75% of the total shares of MSP, Renishaw agrees to exercise its voting rights such that it only votes as if it has the same aggregate shareholding as the remaining Management Shareholders.

13. Investments in associates and joint ventures (continued)

Movements during the year were:

	2021 £'000	2020 £'000
Balance at the beginning of the year	16,604	13,095
Additions	749	4,299
Dividends received	–	(512)
Share of profits of associates and joint ventures	1,683	841
Impairment	(1,674)	(1,306)
Exchange differences	(728)	187
Balance at the end of the year	16,634	16,604

A revision to HiETA's five-year business plan at 30 June 2021, in light of the ongoing effects of the COVID-19 pandemic on certain industries, has resulted in an impairment to Renishaw's investment of £1,674,000. This has also resulted in additional and full impairment of a long-term loan of £2,633,000 and a finance lease impairment of £397,000. These have been accounted for in Administrative expenses in the Consolidated income statement. Other Short-term loans to associates and joint ventures of £598,000 relate to RLS.

Long-term and short-term loans to associates and joint ventures are tested for impairment using discounted cash flow projections at each reporting period, according to five-year business plans approved by management, or where there are indicators of impairment.

Summarised financial information for associates and joint ventures:

	RLS		MSP		HiETA	
	2021 £'000	2020 £'000	2021 £'000	2020 £'000	2021 £'000	2020 £'000
Assets	31,535	28,896	4,211	3,965	3,459	5,171
Liabilities	(3,719)	(4,430)	(1,056)	(623)	(7,780)	(7,494)
Net assets/(liabilities)	27,816	24,466	3,155	3,342	(4,321)	(2,323)
Group's share of net assets/(liabilities)	13,908	12,233	2,209	1,671	(1,426)	(767)
Revenue	25,145	21,447	2,239	2,452	1,973	1,926
Profit/(loss) for the year	4,800	1,974	(182)	1,094	(1,881)	(3,685)
Group's share of profit/(loss) for the year	2,400	987	(91)	547	(626)	(1,088)

14. Leases (as lessor)

The Group acts as lessor for plant and equipment, manufactured by Renishaw, on both an operating and finance lease basis.

Where the Group retains the risks and rewards of ownership of leased assets, it continues to recognise the leased asset in Property, plant and equipment, while the lease payments made during the term of the operating lease are recognised in Revenue (2021: £582,000 and 2020: £1,183,000). Operating leases are on one to four year terms. The total of future minimum lease payments receivable under non-cancellable operating leases were:

	2021 £'000	2020 £'000
Receivable in less than one year	361	742
Receivable between one and four years	306	152
Total future minimum lease payments receivable	667	894

Where the Group transfers the risks and rewards of ownership of leased assets to a third party, the Group recognises a receivable in the amount of the net investment in the lease in Finance lease receivables. The lease receivable is subsequently reduced by the principal received, while an interest component is recognised as financial income in the Consolidated income statement. Standard contract terms are up to five years and there is a nominal residual value receivable at the end of the contract.

The total future lease payments are split between the principal and interest amounts below:

	2021			2020		
	Gross investment £'000	Interest £'000	Net investment £'000	Gross investment £'000	Interest £'000	Net investment £'000
Receivable in less than one year	1,919	156	1,763	2,113	131	1,982
Receivable between one and two years	2,641	215	2,426	2,226	138	2,088
Receivable between two and three years	2,129	173	1,956	1,758	109	1,649
Receivable between three and four years	1,365	111	1,254	1,053	65	988
Receivable between four and five years	696	91	605	81	5	76
Total future minimum lease payments receivable	8,750	746	8,004	7,231	448	6,783

Notes continued

15. Bank deposits and cash and cash equivalents

Bank deposits

Bank deposits at the end of the year amounted to £120,000,000 (2020: £10,000,000), of which £20,000,000 matures on 29 July 2021, £20,000,000 matures on 15 September 2021, £40,000,000 matures on 16 September 2021, and £40,000,000 is on a 90-day notice account.

Cash and cash equivalents

An analysis of cash and cash equivalents at the end of the year was:

	2021 £'000	2020 £'000
Bank balances and cash in hand	93,514	108,609
Short-term deposits	1,494	1,777
Balance at the end of the year	95,008	110,386

Amounts held on bank deposit, where the original term exceeds three months, and the UK defined benefit pension scheme cash escrow account are shown separately within current assets.

16. Inventories

An analysis of inventories at the end of the year was:

	2021 £'000	2020 £'000
Raw materials	38,973	37,717
Work in progress	21,750	18,737
Finished goods	52,840	49,043
Balance at the end of the year	113,563	105,497

During the year, the amount of inventories recognised as an expense in the Consolidated income statement was £177,963,000 (2020: £169,769,000) and the amount of write-down of inventories recognised as an expense in the Consolidated income statement was £269,000 (2020: £7,473,000). At the end of the year, the gross cost of inventories which had provisions held against them totalled £17,389,000 (2020: £21,133,000).

17. Provisions

Warranty provision movements during the year were:

	2021 £'000	2020 £'000
Balance at the beginning of the year	5,591	2,846
Created during the year	2,500	5,308
Utilised in the year	(1,832)	(2,563)
	668	2,745
Balance at the end of the year	6,259	5,591

The warranty provision has been calculated on the basis of historical return-in-warranty information and other internal reports. It is expected that most of this expenditure will be incurred in the next financial year and all expenditure will be incurred within three years of the balance sheet date. Included within the warranty provision is £4,200,000 (2020: £3,400,000) where the warranty cost has been reassessed to be the cost of replacing certain AM machines where the business will not have the capability to honour the warranty on these machines going forward as a result of restructuring activities in 2020. As we will not have the ability to repair or maintain these machines, the warranty cost reflects the cost of replacing these machines. It was expected that these warranty costs would be incurred in 2021, however the replacement product is now expected to be available in early 2022.

18. Contract liabilities

Movements during the year were:

	2021 £'000	2020 £'000
Balance at the beginning of the year	5,976	5,631
Released to revenue	(3,893)	(3,802)
Arising in year	3,864	4,100
Currency translation	173	47
Balance at the end of the year	6,120	5,976

The aggregate amount of the transaction price allocated to performance obligations that are unsatisfied at the end of the year is £6,120,000 (2020: £7,416,000). Of this, £1,682,000 (2020: £1,489,000) is not expected to be recognised in 2022.

19. Other payables

Balances at the end of the year were:

	2021 £'000	2020 £'000
Payroll taxes and social security	7,924	5,833
Performance bonuses	13,208	–
Other creditors and accruals	30,584	28,539
Total other payables	51,716	34,372

Other creditors and accruals includes £2,114,000 (2020: £nil) relating to outstanding third-party fees relating to the 2021 formal sales process ('FSP'), £7,287,000 (2020: £3,087,000) of receivables in payable positions where there is no right of offset, £7,200,000 (2020: £7,003,000) of holiday pay and retirement accruals, and a number of other smaller accruals.

20. Leases (as lessee)

The Group acts as lessee for land and buildings, plant and equipment, and vehicles and recognises leases as a liability in the Consolidated balance sheet, with a corresponding amount recognised as a right-of-use asset.

Lease liabilities are analysed as below:

	2021 £'000	Leasehold property	Plant and equipment	Motor vehicles	Total
Due in less than one year		3,022	42	1,110	4,174
Due between one and two years		2,497	15	591	3,103
Due between two and three years		1,638	9	249	1,896
Due between three and four years		728	5	55	788
Due between four and five years		571	4	1	576
Due in more than five years		5,026	–	–	5,026
Total future minimum lease payments payable		13,482	75	2,006	15,563
Effect of discounting		(2,936)	(2)	(63)	(3,001)
Lease liability		10,546	73	1,943	12,562

	2020 £'000	Leasehold property	Plant and equipment	Motor vehicles	Total
Due in less than one year		3,011	–	1,325	4,336
Due between one and five years		4,754	–	1,130	5,884
Due in more than five years		7,182	–	–	7,182
Total future minimum lease payments payable		14,947	–	2,455	17,402
Effect of discounting		(4,189)	–	(47)	(4,236)
Lease liability		10,758	–	2,408	13,166

	2021 £'000	2020 £'000
Depreciation expense of right-of-use assets	4,463	4,736
Interest expense on lease liabilities	335	766
Expenses relating to short-term and low-value leases	139	80
Total recognised in the Consolidated income statement	4,937	5,582
Total cash outflows for leases	5,289	4,976

21. Borrowings

Third party borrowings at 30 June 2021 consist of a five year loan entered into on 31 May 2019 by Renishaw KK to purchase a new property, with original principal of JPY 1,447,000,000 (£10,486,000). Principal of JPY 12,000,000 is repayable each month, with a fixed interest rate of 0.81% also paid on monthly accretion. The residual principal at 31 May 2024 of JPY 739,000,000 can either be repaid in full at that time, or extended for another five years. Additionally, a Renishaw (Korea) Limited property loan, which had a balance of £1,908,000 at 30 June 2020, was increased by £636,000 and fully repaid during the year.

Borrowings are held at amortised cost. There is no significant difference between the book value and fair value of borrowings, which is estimated by discounting contractual future cash flows, which represents level 2 of the fair value hierarchy defined in note 24.

Movements during the year were:

	2021 £'000	2020 £'000
Balance at the beginning of the year	11,543	10,399
Additions	636	1,894
Interest	69	78
Repayments	(3,477)	(1,136)
Currency adjustment	(1,322)	308
Balance at the end of the year	7,449	11,543

Notes continued

22. Employee benefits

The Group operates defined benefit pension schemes for several Group companies. As noted in the accounting policies, actuarial valuations of overseas pension schemes have not been obtained, except for the schemes relating to Renishaw Ireland (DAC) and Renishaw, Inc. ('the Irish scheme' and 'the US scheme' respectively).

The largest scheme, which covers qualifying UK-based employees, is also of the defined benefit type. This scheme, together with the Irish scheme and the US scheme, are closed to new members and have ceased any future accrual for existing members. These employees are now covered by defined contribution schemes.

The total pension cost of the Group for the year was £19,759,000 (2020: £21,103,000), of which £111,000 (2020: £136,000) related to Directors and £5,256,000 (2020: £5,253,000) related to overseas schemes.

The latest full actuarial valuation of the UK defined benefit pension scheme was carried out as at 30 September 2018 and updated to 30 June 2021 by a qualified independent actuary. The mortality assumption used for 2021 is the S2PxA base tables and CMI 2020 model, with long-term improvements of 1% per annum. Adjustments have been made to both the core base tables and CMI 2020 model to allow for the scheme's membership profile and best estimate assumptions of future mortality improvements.

Major assumptions used by actuaries for the UK, Ireland and US schemes were:

	30 June 2021			30 June 2020		
	UK scheme	Ireland scheme	US scheme	UK scheme	Ireland scheme	US scheme
Rate of increase in pension payments	3.10%	1.70%	–	2.80%	1.30%	–
Lump sum – assumed settlement rate	–	–	0.75%	–	–	0.80%
Discount rate	1.85%	1.10%	2.85%	1.50%	1.10%	2.80%
Inflation rate (RPI)	3.20%	1.70%	–	2.80%	1.30%	–
Inflation rate (CPI)	2.20% ^{pre-2030} 3.10% ^{post-2030}	–	–	2.20%	–	–
Retirement age	64	65	65	64	65	65

The life expectancies implied by the mortality assumption at age 65 and 45 are:

	2021 years	2020 years
Male currently aged 65	22.0	21.4
Female currently aged 65	23.9	23.4
Male currently aged 45	22.7	22.4
Female currently aged 45	24.9	24.6

The weighted average duration of the defined benefit obligation is around 23 years.

The assets and liabilities in the defined benefit pension schemes were:

	30 June 2021 £'000	% of total assets	30 June 2020 £'000	% of total assets
Market value of assets:				
Equities	140,717	61	110,027	58
Multi-asset funds	63,017	27	54,822	29
Credit and fixed income funds	18,833	8	14,339	8
Fixed interest gilts	1,457	1	1,488	1
Index linked gilts	1,843	1	1,929	1
Property	802	0	–	0
Cash and other	4,686	2	6,014	3
	231,355	100	188,619	100
Actuarial value of liabilities	(255,053)	–	(253,514)	–
Deficit in the schemes	(23,698)	–	(64,895)	–
Deferred tax thereon	4,347	–	11,896	–

Note C.40 gives the analysis of the UK defined benefit pension scheme. For the other schemes, the market value of assets at the end of the year was £26,396,000 (2020: £25,681,000) and the actuarial value of liabilities was £30,930,000 (2020: £31,948,000).

22. Employee benefits (continued)

Equities are held in externally-managed funds and primarily relate to UK and US equities. Credit and fixed income funds, fixed interest gilts, and index linked gilts relate to UK, US and Eurozone government-linked securities, again held in externally-managed funds. The fair values of these equity and fixed income instruments are determined using the bid price of the unitised investments, quoted by the investment manager, at the reporting date and therefore represent 'Level 2' of the fair value hierarchy defined in note 24.

Multi-asset funds are also held in externally-managed funds, with active asset allocation to diversify growth across asset classes such as equities, bonds and money-market instruments. The fair value of these funds is determined on a comparable basis to the equity and fixed income funds, and therefore are also 'Level 2' assets.

No scheme assets are directly invested in the Group's own equity.

The UK scheme is closed for future accrual and is expected to mature over the coming years, and therefore while the focus of the investment strategy remains on growth the trustees intend to start gradually de-risking the investments where (and when) appropriate.

The overall target investment strategy for the UK scheme for the period to 30 June 2021 was to hold 61% of investment assets in equities, 34% in diversified growth funds and 5% in fixed income. Contributions over the year were predominantly invested in buy and maintain credit, bringing the current actual allocation up to 6% of assets. Remaining contributions have been held in a cash fund, pending investment into a multi-asset credit mandate.

The movements in the schemes' assets and liabilities were:

	Assets £'000	Liabilities £'000	Total £'000
Year ended 30 June 2021			
Balance at the beginning of the year	188,619	(253,514)	(64,895)
Contributions paid	8,866	–	8,866
Interest on pension schemes	2,933	(3,809)	(876)
Remeasurement loss from GMP equalisation	–	(78)	(78)
Remeasurement gain/(loss) under IAS 19, the asset ceiling and IFRIC 14	36,824	(3,539)	33,285
Benefits paid	(5,887)	5,887	–
Balance at the end of the year	231,355	(255,053)	(23,698)
Year ended 30 June 2020			
Balance at the beginning of the year	181,588	(233,458)	(51,870)
Contributions paid	11,814	–	11,814
Interest on pension schemes	4,371	(5,232)	(861)
Remeasurement loss under IAS 19	(2,237)	(21,741)	(23,978)
Benefits paid	(6,917)	6,917	–
Balance at the end of the year	188,619	(253,514)	(64,895)

In November 2020 the High Court of England and Wales issued a supplementary ruling in the Lloyds Bank GMP equalisation case with respect to members that have transferred out of their scheme prior to the ruling. The result of this means that Trustees are obliged to make transfer payments that reflect equalised benefits and are required to make top up payments where this was not the case in the past, and a defined benefit pension scheme that received a transfer is concurrently obliged to provide equalised benefits in respect of the transfer payments. We determined an estimated cost of the impact of this ruling for the UK fund of £78,000, which has been recognised through Administrative expenses in the Consolidated income statement as a past service cost.

The analysis of the amount recognised in the Consolidated statement of comprehensive income and expense was:

	2021 £'000	2020 £'000
Actuarial gain/(loss) arising from:		
Changes in demographic assumptions	(2,669)	(682)
Changes in financial assumptions	4,643	(22,402)
Experience adjustment	2,631	1,648
Adjustment related to the application of revaluation and late retirement factors	14,300	–
Return on plan assets excluding interest income	36,823	(2,542)
Adjustment for the asset ceiling	(3,280)	–
Adjustment to liabilities for IFRIC 14	(19,163)	–
Total amount recognised in the Consolidated statement of comprehensive income and expense	33,285	(23,978)

The cumulative amount of actuarial gains and losses recognised in the Consolidated statement of comprehensive income and expense was a loss of £91,497,000 (2020: loss of £124,782,000).

Notes continued

22. Employee benefits (continued)

The total deficit of the Group's defined benefit pension schemes, on an IAS 19 basis (excluding the asset ceiling and IFRIC 14 adjustments), has decreased from £64,895,000 at 30 June 2020 to £1,254,000 at 30 June 2021, primarily reflecting the net effect of:

- an increase in the discount rate of the UK scheme;
- an increase in RPI for the UK and Irish schemes;
- an increase in CPI for the UK scheme;
- strong performance of the investment assets of the UK, Irish and US schemes; and
- an adjustment relating to the application of revaluation and late retirement factors, which is discussed further below.

For the UK scheme, the latest actuarial report prepared in September 2018 shows a deficit of £70,700,000, which is based on funding to self-sufficiency and uses prudent assumptions. IAS 19 requires best estimate assumptions to be used, resulting in the IAS 19 deficit being lower than the actuarial deficit.

For the UK defined benefit scheme, a guide to the sensitivity of the value of the respective liabilities is as follows:

	Variation	Approximate effect on liabilities
UK – discount rate	Increase/decrease by 0.5%	-£21.2m/+£24.4m
UK – future inflation	Increase/decrease by 0.5%	+£20.3m/-£17.1m
UK – mortality	Increased/decreased life by one year	+£9.2m/-£8.9m

In October 2020, the Trustees of the Renishaw Pension Fund ('the UK defined benefit scheme') notified the Company of a difference between the calculated estimate of liabilities in the scheme for administration purposes and for accounting purposes. Differing legal interpretations of the Trust Deed and Rules were subsequently concluded by legal firms instructed by the Trustees and the Company, mostly relating to the periods over which revaluation and late retirement factors are applied, with significant differences in the financial impact noted. Consequently, in April 2021, the Trustees and the Company jointly instructed Queen's Counsel to opine on a legal interpretation of the Trust Deed and Rules that both parties would accept. This resulted in another interpretation of the Trust Deed and Rules which is now the accepted legal position, with a £14,300,000 reduction in liabilities calculated on this basis. This change in liability estimate in the year relates to benefits for some members payable in future years, and has been accounted for within the 'Remeasurement of defined benefit pension scheme liabilities' in the Consolidated statement of other comprehensive income and expense.

A deficit funding plan for the UK defined benefit pension scheme was agreed with The Pensions Regulator in 2018, which superseded all previous arrangements. The Company agreed to pay £8,700,000 per annum into the scheme for five years with effect from 1 October 2018.

The present value of the expected payments under the plan at 30 June 2021 totalled £19,163,000, which compares to the IAS 19 pension scheme surplus of £3,280,000 at 30 June 2021. As such, an adjustment of £3,280,000 has been recognised in respect of the asset ceiling restriction, on the basis that the surplus is not deemed to be recoverable, and £19,163,000 has been recognised in accordance with IFRIC 14, to present a net liability position of £19,163,000. At 30 June 2020, the IAS 19 deficit was higher than the present value of expected payments, such that no adjustment was recognised.

A number of UK properties owned by the Company with a book value of £81,679,000 at 30 June 2021 are subject to registered fixed charges and continue to provide security to the scheme under the deficit funding plan. The Company also has an escrow bank account with a balance of £10,578,000 at the end of the year (2020: £10,568,000) which is subject to a registered floating charge. There is no scheduled release of funds back to the Company under the deficit funding plan.

In the event a subsequent actuarial valuation results in the combined value of the properties and the escrow bank account exceeding 120% of the actuarial deficit, some of the contingent assets will be released back to the Company. Any remaining contingent assets will be released from charge when the deficit no longer exists.

The current agreement will continue until 30 June 2031 and any outstanding deficit paid at that time. The agreement will end sooner if the actuarial deficit (calculated on a self-sufficiency basis) is eliminated in the meantime.

The charges may be enforced by the Trustees if one of the following occurs: (a) the Company does not pay funds into the scheme in line with the agreed plan; (b) an insolvency event occurs in relation to the Company; or (c) the Company does not pay any deficit at 30 June 2031.

Under the Ireland defined benefit pension scheme deficit funding plan, a property owned by Renishaw Ireland (DAC) is subject to a registered fixed charge to secure the Ireland defined benefit pension scheme's deficit.

23. Share-based payments

In accordance with the remuneration policy approved by shareholders at the 2017 AGM, the deferred annual equity incentive plan ('the Plan') was implemented in relation to the financial year ending 30 June 2018. The 20 July 2018 Remuneration Committee meeting recommended plan rules that were adopted by a resolution of the Board on 24 July 2018. The Committee also approved the grant of awards under the Plan to the participating Executive Directors.

The number of shares to be awarded is calculated by dividing the relevant amount of annual bonus under the Plan by the average price of a share during a period determined by the Committee of not more than five dealing days ending with the dealing day before the award date. These shares must be purchased on the open market and cannot be satisfied by issuance of new shares or transfer of existing treasury shares.

An employee benefit trust (EBT) exists to purchase and hold such shares, until transferring to the employee, which will normally be on the third anniversary of the award date, subject to continued employment. Malus and clawback provisions can be operated by the Committee within five years of the award date. During the vesting period, no dividends are payable on the shares. However, upon vesting, employees will be entitled to additional shares or cash, equivalent to the value of dividends paid on the awarded shares during this period.

The total cost recognised in the 2021 Consolidated income statement in respect of the Plan was £173,000 (2020: £173,000).

In accordance with the Plan, amounts equivalent to £734,317 (2020: £nil) have been awarded in respect of 2021.

See pages 82–84 of the Directors' Remuneration Report for further details of the Plan and awards granted.

24. Financial instruments

The Group has exposure to credit risk, liquidity risk and market risk arising from its use of financial instruments. This note presents information about the Group's exposure to these risks, along with the Group's objectives, policies and processes for measuring and managing the risks.

Fair value

There is no significant difference between the fair value of financial assets and financial liabilities and their carrying value in the Consolidated balance sheet. All financial assets and liabilities are held at amortised cost, apart from the forward foreign currency exchange contracts, which are held at fair value, with changes going through the Consolidated income statement unless subject to hedge accounting.

The fair values of the forward foreign currency exchange contracts have been calculated by a third-party expert, discounting estimated future cash flows on the basis of market expectations of future exchange rates, representing level 2 in the IFRS 13 fair value hierarchy. The IFRS 13 level categorisation relates to the extent the fair value can be determined by reference to comparable market values. The classifications are: level 1 where instruments are quoted on an active market; level 2 where the assumptions used to arrive at fair value have comparable market data; and level 3 where the assumptions used to arrive at fair value do not have comparable market data.

Credit risk

The Group's liquid funds are substantially held with banks with high credit ratings and the credit risk relating to these funds is therefore limited. The Group carries a credit risk relating to non-payment of trade receivables by its customers. The Group's policy is that credit evaluations are carried out on all new customers before credit is given above certain thresholds. There is a spread of risks among a large number of customers with no significant concentration with one customer or in any one geographical area. The Group establishes an allowance for impairment in respect of trade receivables where recoverability is considered doubtful.

An analysis by currency of the Group's financial assets at the year end is as follows:

Currency	Trade & finance lease receivables		Other receivables		Cash and bank deposits	
	2021 £'000	2020 £'000	2021 £'000	2020 £'000	2021 £'000	2020 £'000
Pound Sterling	16,915	9,293	23,752	16,974	174,905	75,052
US Dollar	39,603	33,358	815	946	9,511	7,096
Euro	23,476	15,607	1,144	1,663	8,118	6,324
Japanese Yen	16,568	20,416	173	337	3,786	4,553
Other	26,103	33,186	4,137	3,276	18,688	27,361
	122,665	111,860	30,021	23,196	215,008	120,386

The above trade receivables, finance lease receivables, other receivables and cash are predominately held in the functional currency of the relevant entity, with the exception of £20,447,000 of US Dollar-denominated trade receivables being held in Renishaw (Hong Kong) Limited and £1,761,000 of Euro-denominated trade receivables being held in Renishaw UK Sales Limited, along with some foreign currency cash balances which are of a short-term nature.

Other receivables include mostly prepayments, a proportion of the R&D tax credit receivable, and indirect tax receivables. Prepayment balances are reviewed at each reporting period to confirm that prepaid goods or services are still expected to be received, while tax balances are reviewed for recoverability.

Notes continued

24. Financial instruments (continued)

The ageing of trade receivables past due, but not impaired, at the end of the year was:

	2021 £'000	2020 £'000
Past due zero to one month	10,537	11,703
Past due one to two months	2,704	4,510
Past due more than two months	6,283	15,495
Balance at the end of the year	19,524	31,708

Movements in the provision for impairment of trade receivables during the year were:

	2021 £'000	2020 £'000
Balance at the beginning of the year	5,965	3,081
Changes in amounts provided	(1,994)	3,254
Amounts used	(145)	(370)
Balance at the end of the year	3,826	5,965

The Group applies the simplified approach when measuring the expected credit loss for trade receivables, with a provision matrix used to determine a lifetime expected credit loss.

For this provision matrix, trade receivables are grouped into credit risk categories, with category 1 being the lowest risk and category 5 the highest. Risk scores are allocated to the customer's country of operation, their type (such as distributor, end-user and OEM), their industry and the proportion of their debt that was past due at the year-end. These scores are then weighted to produce an overall risk score for the customer, with the lowest scores being allocated to category 1 and the highest scores to category 5.

The matrix then applies an expected credit loss rate to each category, with this rate being determined by adjusting the Group's historic credit loss rates to reflect forward-looking information. This includes management's latest assessment of the impact of COVID-19 and the recent improvements in global macroeconomic conditions, which has resulted in a decrease in the expected credit loss rate, and the expected credit loss allowance, compared to the prior year.

Where certain customers have been identified as having a significantly elevated credit risk these have been provided for on a specific basis. Both elements of expected credit loss are shown in the matrix below and have been shown separately so as not to distort the expected credit loss rate.

Year ended 30 June 2021	Risk category 1 £'000	Risk category 2 £'000	Risk category 3 £'000	Risk category 4 £'000	Risk category 5 £'000	2021 Total £'000
Gross trade receivables	9,154	38,759	65,870	3,806	898	118,487
Expected credit loss rate	0.28%	0.31%	0.31%	0.36%	0.39%	0.31%
Expected credit loss allowance	26	119	205	14	3	367
Specific loss allowance	–	–	2,080	1,138	241	3,459
Total expected credit loss	26	119	2,285	1,152	244	3,826
Net trade receivables	9,128	38,640	63,585	2,654	654	114,661
Year ended 30 June 2020	Risk category 1 £'000	Risk category 2 £'000	Risk category 3 £'000	Risk category 4 £'000	Risk category 5 £'000	2020 Total £'000
Gross trade receivables	714	39,931	64,908	5,187	302	111,042
Expected credit loss rate	1.24%	1.35%	1.42%	1.58%	1.69%	1.40%
Expected credit loss allowance	9	541	922	82	5	1,559
Specific loss allowance	–	–	3,730	676	–	4,406
Total expected credit loss	9	541	4,652	758	5	5,965
Net trade receivables	705	39,390	60,256	4,429	297	105,077

The Group has no material contract assets, and finance lease receivables are subject to the same approach as noted above for trade receivables.

The maximum exposure to credit risk is £377,333,000 (2020: £259,200,000), comprising the Group's trade, finance and other receivables, cash and cash equivalents and derivative assets.

The maturities of non-current other receivables, being long-term loans to associates and joint ventures and derivatives, at the year end were:

	2021 £'000	2020 £'000
Receivable between one and two years	12,484	905
Receivable between two and five years	–	3,155
	12,484	4,060

24. Financial instruments (continued)

Liquidity risk

Our approach to managing liquidity is to ensure, as far as possible, that we will always have sufficient liquidity to meet our liabilities when due, without incurring unacceptable losses or risking damage to the Group's reputation. We use monthly cash flow forecasts on a rolling 12-month basis to monitor cash requirements.

With net cash and bank deposits at 30 June 2021 totalling £215,008,000, an increase of £94,622,000 from 30 June 2020, the Group's liquidity has improved in the period.

In respect of net cash and bank deposits, the carrying value is materially the same as fair value because of the short maturity of the bank deposits. Bank deposits are affected by interest rates that are either fixed or floating, which can change over time, affecting the Group's interest income. An increase of 1% in interest rates would result in an increase in interest income of approximately £1,200,000.

The contractual maturities of financial liabilities at the year end were:

Year ended 30 June 2021	Contractual cash flows					
	Carrying amount £'000	Effect of discounting £'000	Gross maturities £'000	Up to 1 year £'000	1–2 years £'000	2–5 years £'000
Trade payables	24,715	–	24,715	24,715	–	–
Other payables	51,716	–	51,716	51,716	–	–
Borrowings	7,448	145	7,593	992	6,601	–
Forward exchange contracts	5,949	–	5,949	5,594	355	–
	89,828	145	89,973	83,017	6,956	–

Year ended 30 June 2020	Contractual cash flows					
	Carrying amount £'000	Effect of discounting £'000	Gross maturities £'000	Up to 1 year £'000	1–2 years £'000	2–5 years £'000
Trade payables	16,998	–	16,998	16,998	–	–
Other payables	34,372	–	34,372	34,372	–	–
Borrowings	11,543	226	11,769	1,149	3,034	7,586
Forward exchange contracts	63,648	–	63,648	22,546	29,220	11,882
	126,561	226	126,787	75,065	32,254	19,468

Changes in liabilities arising from financing activities

	1 July 2020	Cash flows	Other	Currency	30 June 2021
Lease liabilities	13,166	(4,815)	4,815	(604)	12,562
Borrowings	11,543	(2,841)	69	(1,322)	7,449
	24,709	(7,656)	4,884	(1,926)	20,011
	1 July 2019	Cash flows	Other	Currency	30 June 2020
Lease liabilities	14,247	(4,896)	4,000	(185)	13,166
Borrowings	10,399	758	78	308	11,543
	24,646	(4,138)	4,078	123	24,709

See notes 20 and 21 for further details on borrowing and leasing activities.

Market risk

As noted in the Strategic Report under Principal risks and uncertainties, the Group operates in a number of foreign currencies with the majority of sales being made in these currencies, but with most manufacturing being undertaken in the UK, Ireland and India.

The Group enters into US Dollar, Euro and Japanese Yen derivative financial instruments to manage its exposure to foreign currency risk, including:

- forward foreign currency exchange contracts to hedge a significant proportion of the Group's forecasted US Dollar, Euro and Japanese Yen revenues over the next 24 months;
- foreign currency option contracts, entered into alongside the forward contracts above until May 2018 as part of the Group hedging strategy, are ineffective for cash flow hedging purposes. Note 28, 'Alternative performance measures', gives an adjusted measure of profit before tax to reflect the original intention that these derivatives were entered into for hedging purposes. The final option contract will mature in November 2021; and
- one-month forward foreign currency exchange contracts to offset the gains/losses from exchange rate movements arising from foreign currency-denominated intragroup balances of the Company.

Notes continued

24. Financial instruments (continued)

For both the Group and the Company, the following table details the fair value of these forward foreign currency derivatives according to the categorisations of instruments noted on page 137:

	2021		2020	
	Nominal value £'000	Fair value £'000	Nominal value £'000	Fair value £'000
Forward currency contracts in a designated cash flow hedge (i)				
Non-current derivative assets	172,165	9,865	78,527	1,133
Current derivative assets	127,548	7,512	19,467	283
Current derivative liabilities	74,652	(3,063)	154,045	(11,415)
Non-current derivative liabilities	34,245	(322)	290,499	(24,925)
	408,610	13,992	542,538	(34,924)
Amounts recognised in the Consolidated statement of comprehensive income and expense	–	51,590	–	13,924
Forward currency contracts ineffective as a cash flow hedge (i)				
Non-current derivative assets	56,357	2,619	–	–
Current derivative assets	31,011	428	–	–
Current derivative liabilities	59,529	(1,653)	93,962	(10,030)
Non-current derivative liabilities	6,687	(33)	153,585	(16,021)
	153,585	1,361	247,547	(26,051)
Amounts recognised in Gains/(losses) from the fair value of financial instruments in the Consolidated income statement	–	22,824	–	(24,361)
Foreign currency options ineffective as a cash flow hedge (ii)				
Non-current derivative assets	–	–	–	108
Current derivative assets	–	1,699	–	3,394
Current derivative liabilities	–	(216)	–	(122)
Non-current derivative liabilities	–	–	–	(155)
	–	1,483	–	3,225
Amounts recognised in Gains/(losses) from the fair value of financial instruments in the Consolidated income statement		(846)	–	2,021
Forward currency contracts not in a designated cash flow hedge (iii)				
Current derivative assets	–	–	5,127	80
Current derivative liabilities	51,929	(662)	62,549	(979)
	51,929	(662)	67,676	(899)
Amounts recognised in Financial income/(expense) in the Consolidated income statement	–	2,781	–	(154)
Total forward contracts and options				
Non-current derivative assets	228,522	12,484	78,527	1,242
Current derivative assets	158,559	9,639	24,594	3,758
Current derivative liabilities	186,110	(5,594)	310,556	(22,546)
Non-current derivative liabilities	40,932	(355)	444,085	(41,102)
	614,123	16,174	857,762	(58,648)

The amounts of foreign currencies relating to these forward contracts and options are, in Sterling terms:

	2021		2020	
	Nominal value £'000	Fair value £'000	Nominal value £'000	Fair value £'000
US Dollar	399,065	4,192	596,032	(56,562)
Euro	146,120	6,040	159,221	409
Japanese Yen	68,938	5,942	102,509	(2,495)
	614,123	16,174	857,762	(58,648)

24. Financial instruments (continued)

The following are the exchange rates which have been applicable during the financial year:

Currency	2021			2020		
	Average forward contract rate	Year end exchange rate	Average exchange rate	Average forward contract rate	Year end exchange rate	Average exchange rate
US Dollar	1.37	1.38	1.36	1.37	1.24	1.26
Euro	1.09	1.17	1.14	1.09	1.10	1.14
Japanese Yen	136	154	145	136	134	136

For the Group's foreign currency forward contracts and options at the balance sheet date, if Sterling appreciated by 5% against the US Dollar, Euro and Japanese Yen, this would increase pre-tax equity by £31,300,000 and increase profit before tax by £9,200,000, while a depreciation of 5% would decrease pre-tax equity by £4,100,000 and decrease profit before tax by £1,100,000.

Hedging

In relation to the forward currency contracts in a designated cash flow hedge, the hedged item is a layer component of forecast sales transactions. Forecast transactions are deemed highly probable to occur and Group policy is to hedge around 75% of net foreign currency exposure for USD, EUR and JPY. The hedged item creates an exposure to receive USD, EUR or JPY, while the forward contract is to sell USD, EUR or JPY and buy GBP. Therefore, there is a strong economic relationship between the hedging instrument and the hedged item. The hedge ratio is 100%, such that, by way of example, £10m nominal value of forward currency contracts are used to hedge £10m of forecast sales. Fair value gains or losses on the forward currency contracts are offset by foreign currency gain or losses on the translation of USD, EUR and JPY based sales revenue, relative to the forward rate at the date the forward contracts were arranged. Foreign currency exposures in HKD and USD are aggregated and only USD forward currency contracts are used to hedge these currency exposures. Sources of hedge ineffectiveness according to IFRS 9 Financial Instruments include: changes in timing of the hedged item; reduction in the amount of the hedged sales considered to be highly probable; a change in the credit risk of Renishaw or the bank counterparty to the forward contract; and differences in assumptions used in calculating fair value.

During 2020, global macroeconomic uncertainty resulted in a reduction to the 'highly probable' revenue forecasts of Renishaw plc and Renishaw UK Sales Limited, being the hedged item, which resulted in proportions of forward contracts failing hedge effectiveness testing, with nominal value amounting to £247,547,000. Following maturities during 2021, the remaining nominal value of ineffective forward contracts at 30 June 2021 totalled £153,585,000, with fair value gains of £22,824,000 recognised in the Consolidated income statement relating to movements in the mark-to-market valuations of these outstanding contracts.

During 2021, an improvement in global macroeconomic conditions and business performance has resulted in an increase to the 'highly probable' revenue forecasts of the hedged item, such that no additional contracts have become ineffective. A decrease of 10% in the highly probable forecasts would result in an additional £7,430,000 notional value of forward contracts becoming ineffective, with a £818,000 gain immediately recycled to the Consolidated income statement based on 30 June 2021 mark-to-market valuations.

25. Share capital and reserves

Capital management

The Group defines capital as being the equity attributable to the owners of the Company, which is captioned on the Consolidated balance sheet. The Board's policy is to maintain a strong capital base and to maintain a balance between significant returns to shareholders, with a progressive dividend policy, while ensuring the security of the Group is supported by a sound capital position. The Group may adjust dividend payments due to changes in economic and market conditions which affect, or are anticipated to affect, Group results.

Share capital

	2021 £'000	2020 £'000
Allotted, called-up and fully paid 72,788,543 ordinary shares of 20p each	14,558	14,558

The ordinary shares are the only class of share in the Company. Holders of ordinary shares are entitled to vote at general meetings of the Company and receive dividends as declared. The Articles of Association of the Company do not contain any restrictions on the transfer of shares nor on voting rights.

Dividends paid

Dividends paid comprised:

	2021 £'000	2020 £'000
2020 final dividend paid of nil per share (2019: 46.0p)	–	33,478
Interim dividend paid of 14.0p per share (2020: nil)	10,189	–
Total dividends paid	10,189	33,478

Notes continued

25. Share capital and reserves (continued)

As a result of the outbreak of the COVID-19 pandemic, and according to the Board's priority of conserving cash and managing the Group in a prudent manner during a period of uncertainty, no final dividend was declared in respect of 2020. Following an improvement in global macroeconomic conditions and the financial position of the Group during 2021, the Board have reinstated the dividend, with an interim dividend of 14.0p per share paid in April 2021. A final dividend of 52.0p per share is proposed in respect of 2021, which will be payable on 29 November 2021 to shareholders on the register on 29 October 2021.

Currency translation reserve

The currency translation reserve comprises all foreign exchange differences arising from the translation of the financial statements of the overseas operations and currency movements on intragroup loan balances classified as net investments in overseas operations (see note 5).

Movements during the year were:

	2021 £'000	2020 £'000
Balance at the beginning of the year	17,729	14,577
(Loss)/gain on net assets of foreign currency operations	(7,009)	996
(Loss)/gain on intragroup loans classified as net investments in foreign operations	(7,743)	2,373
Tax on translation of net investments in foreign operations	1,470	(403)
(Loss)/gain in the year relating to subsidiaries	(13,282)	2,966
Currency exchange differences relating to associates and joint ventures	(728)	186
Balance at the end of the year	3,719	17,729

Cash flow hedging reserve

The cash flow hedging reserve, for both the Group and the Company, comprises all foreign exchange differences arising from the valuation of forward exchange contracts which are effective hedges and mature after the year end. These are valued on a mark-to-market basis, are accounted for in Other comprehensive income and expense and accumulated in Equity, and are recycled through the Consolidated income statement and Company income statement when the hedged item affects the income statement, or when the hedging relationship ceases to be effective. See note 24 for further detail.

Movements during the year were:

	2021 £'000	2020 £'000
Balance at the beginning of the year	(30,455)	(42,401)
Losses on contract maturity recognised in revenue during the year	(608)	16,216
Losses transferred to the Consolidated income statement during the year	–	24,361
Deferred tax transferred to the Consolidated income statement	–	(4,629)
Revaluations during the year	52,198	(26,653)
Deferred tax movement	(9,790)	2,651
Balance at the end of the year	11,345	(30,455)

Own shares held

The EBT is responsible for purchasing shares on the open market on behalf of the Company to satisfy the Plan awards, see note 23 for further detail. Own shares held are recognised as an element in equity until they are transferred at the end of the vesting period.

Movements during the year were:

	2021 £'000	2020 £'000
Balance at the beginning of the year	(404)	(404)
Acquisition of own shares	–	–
Balance at the end of the year	(404)	(404)

On 10 December 2018, 9,639 shares were purchased on the open market by the EBT at a price of £41.66, costing a total of £404,348.

Other reserve

The other reserve relates to additional investments in subsidiary undertakings and share-based payments charges according to IFRS 2 in relation to the Plan.

Movements during the year were:

	2021 £'000	2020 £'000
Balance at the beginning of the year	(129)	(302)
Share-based payments charge	173	173
Balance at the end of the year	44	(129)

25. Share capital and reserves (continued)

Non-controlling interest

Movements during the year were:

	2021 £'000	2020 £'000
Balance at the beginning of the year	(577)	(577)
Share of profit for the year	-	-
Balance at the end of the year	(577)	(577)

The non-controlling interest represents the minority shareholdings in Renishaw Diagnostics Limited – 7.6%.

26. Capital commitments

Authorised and committed capital expenditure at the end of the year, for which no provision has been made in the Financial statements, were:

	2021 £'000	2020 £'000
Freehold land and buildings	412	640
Plant and equipment	3,255	1,621
Motor vehicles	79	-
Software licences and intellectual property	68	3,854
Total committed capital expenditure	3,814	6,115

27. Related parties

Associates, joint ventures and other related parties had the following transactions and balances with the Group:

	Joint ventures		Associate	
	2021 £'000	2020 £'000	2021 £'000	2020 £'000
Purchased goods and services from the Group during the year	711	837	642	526
Sold goods and services to the Group during the year	22,175	17,160	-	-
Paid dividends to the Group during the year	-	512	-	-
Amounts owed to the Group at the year end	146	87	2,747	3,227
Amounts owed by the Group at the year end	2,556	3,103	-	-
Loans owed to the Group at the year end	598	955	-	2,500

Loans and finance leases owed to the Group by an associate totalling £3,030,000 were impaired in 2021. There were no bad debts relating to related parties written off during 2020.

By virtue of their long-standing voting agreement, Sir David McMurtry (Executive Chairman 36.23% shareholder) and John Deer (Non-executive Deputy Chairman, together with his wife, 16.59%), are the ultimate controlling party of the Group. See page 96 of the Governance Report for further details in relation to this. The only significant transactions between the Group and these parties are in relation to their respective remuneration, as detailed on pages 77–93 of the Governance Report.

28. Alternative performance measures

In accordance with Renishaw's alternative performance measures (APMs) policy and ESMA Guidelines on Alternative Performance Measures (2015), APMs are defined as - Revenue at constant exchange rates, Adjusted profit before tax, Adjusted earnings per share and Adjusted operating profit.

Revenue at constant exchange rates is defined as revenue recalculated using the same rates as were applicable to the previous year and excluding forward contract gains and losses.

Revenue at constant exchange rates:	2021 £'000	2020 £'000
Statutory revenue as reported	565,559	510,215
Adjustment for forward contract (gains)/losses	(1,427)	12,053
Adjustment to restate current year at previous year exchange rates	26,206	-
Revenue at constant exchange rates	590,338	522,268
Year-on-year revenue growth at constant exchange rates	+13.0%	-

Year-on-year revenue growth at constant exchange rates for 2020 was -13.2%.

Adjusted profit before tax, Adjusted earnings per share and Adjusted operating profit are defined as the profit before tax, earnings per share and operating profit after excluding costs relating to business restructuring, third-party costs relating to the formal sales process ('FSP'), and gains and losses in fair value from forward currency contracts which did not qualify for hedge accounting and which have yet to mature.

Notes continued

28. Alternative performance measures (continued)

Restructuring costs reported separately in the Consolidated income statement (see note 29), and third-party legal and advisory costs relating to the 2021 FSP reported in Administrative expenses, have been excluded from adjusted measures on the basis that they relate to matters that do not frequently recur.

From 2017, the gains and losses from the fair value of financial instruments not effective for cash flow hedging have been excluded from statutory profit before tax, statutory earnings per share and statutory operating profit in arriving at Adjusted profit before tax, Adjusted earnings per share and Adjusted operating profit to reflect the Board's intent that the instruments would provide effective hedges. This is classified as 'Fair value (gains)/losses on financial instruments not eligible for hedge accounting (i)' in the following reconciliations. The amounts shown as reported in revenue represent the amount by which revenue would change had all the derivatives qualified as eligible for hedge accounting.

Gains and losses which recycle through the Consolidated income statement as a result of contracts deemed ineffective during 2020, as described in note 24, are also excluded from adjusted profit measures, on the basis that all forward contracts are still expected to be effective hedges for Group revenue, while the potentially high volatility in fair value gains and losses relating to these contracts will otherwise cause confusion for users of the financial statements wishing to understand the underlying trading performance of the Group. This is classified as 'Fair value (gains)/losses on financial instruments not eligible for hedge accounting (ii)' in the following reconciliations.

The Board considers these alternative performance measures to be more relevant and reliable in evaluating the Group's performance.

	2021 £'000	2020 £'000
Adjusted profit before tax:		
Statutory profit before tax	139,439	3,208
Restructuring costs	–	23,797
Third-party FSP costs	3,222	–
Fair value (gains)/losses on financial instruments not eligible for hedge accounting (i):		
– reported in revenue	1,882	(731)
– reported in (gains)/losses from the fair value of financial instruments	846	(2,021)
Fair value (gains)/losses on financial instruments not eligible for hedge accounting (ii):		
– reported in revenue	(2,899)	–
– reported in (gains)/losses from the fair value of financial instruments	(22,824)	24,361
Adjusted profit before tax	119,666	48,614
Adjusted earnings per share:	2021 pence	2020 pence
Statutory earnings per share	153.2	0.4
Restructuring costs	–	26.5
Third-party FSP costs	4.4	–
Fair value (gains)/losses on financial instruments not eligible for hedge accounting (i):		
– reported in revenue	2.1	(0.8)
– reported in (gains)/losses from the fair value of financial instruments	0.9	(2.2)
Fair value (gains)/losses on financial instruments not eligible for hedge accounting (ii):		
– reported in revenue	(3.2)	–
– reported in (gains)/losses from the fair value of financial instruments	(25.4)	27.1
Adjusted earnings per share	132.0	51.0
Adjusted operating profit:	2021 £'000	2020 £'000
Statutory operating profit	138,341	6,294
Restructuring costs	–	23,797
Third-party FSP costs	3,222	–
Fair value (gains)/losses on financial instruments not eligible for hedge accounting (i):		
– reported in revenue	1,882	(731)
– reported in (gains)/losses from the fair value of financial instruments	846	(2,021)
Fair value (gains)/losses on financial instruments not eligible for hedge accounting (ii):		
– reported in revenue	(2,899)	–
– reported in (gains)/losses from the fair value of financial instruments	(22,824)	24,361
Adjusted operating profit	118,568	51,700

28. Alternative performance measures (continued)

Adjustments to the segmental operating profit:

	2021 £'000	2020 £'000
Manufacturing technologies		
Operating profit before loss from fair value of financial instruments	110,498	31,188
Restructuring costs	–	23,797
Third-party FSP costs	3,061	–
Fair value (gains)/losses on financial instruments not eligible for hedge accounting (i):		
– reported in revenue	1,797	(688)
Fair value (gains)/losses on financial instruments not eligible for hedge accounting (ii):		
– reported in revenue	(2,734)	(4,036)
Adjusted manufacturing technologies operating profit	112,622	50,261
Analytical instruments and medical devices		
Operating profit before loss from fair value of financial instruments	5,865	1,737
Third-party FSP costs	161	–
Fair value (gains)/losses on financial instruments not eligible for hedge accounting (i):		
– reported in revenue	86	(43)
Fair value (gains)/losses on financial instruments not eligible for hedge accounting (ii):		
– reported in revenue	(166)	(255)
Adjusted analytical instruments and medical devices operating profit	5,946	1,439

29. Restructuring costs

During 2020 the Board implemented its 'Fit for the Future' initiative, which incorporated the rationalisation and reorganisation of certain operating activities, particularly relating to the additive manufacturing (AM) business, and cost control measures which included a UK compulsory redundancy programme.

The Board considered that the costs relating to these restructuring activities should be reported separately in the Consolidated income statement in order to aid users' understanding. No expenses relating to this initiative have been incurred in 2021. The table below shows the analysis of these costs:

	2020 £'000
Redundancy costs (a)	6,281
Impairment of capitalised research and development costs (b)	5,999
Impairment of goodwill (c)	405
Impairment of property, plant and equipment (a)	2,590
Increase in inventory provisions (b)	4,910
Increase in warranty provisions (b)	3,400
Other expenses (c)	212
Total restructuring costs	23,797

These costs would be found under the following headings in the Consolidated income statement if they had not been separately identified in Restructuring costs: (a) within cost of sales, distribution costs and administrative expenses; (b) within cost of sales; and (c) within administrative expenses.

Company balance sheet

at 30 June 2021

	notes	2021 £'000	2020 £'000
Assets			
Property, plant and equipment	C.31	136,091	144,319
Right-of-use assets		1,828	1,857
Intangible assets	C.32	29,228	27,371
Investments in subsidiaries	C.33	288,548	288,548
Investments in associates and joint ventures	C.34	1,453	2,999
Long-term loans to Group undertakings		89,621	96,234
Long-term loans to associates and joint ventures		–	2,818
Deferred tax assets	C.35	–	18,509
Derivatives	24	12,484	1,242
Total non-current assets		559,253	583,897
Current assets			
Inventories	C.36	68,462	60,313
Trade receivables	C.37	68,309	63,523
Short-term loans to Group undertakings		725	4,083
Short-term loans to associates and joint ventures		598	318
Current tax		674	2,850
Other receivables		22,409	16,783
Derivatives	24	9,639	3,758
Pension scheme cash escrow account	22	10,578	10,568
Bank deposits	15	120,000	10,000
Cash and cash equivalents		53,921	71,576
Total current assets		355,315	243,772
Current liabilities			
Trade payables		16,408	9,163
Short-term loans from Group undertakings		5,956	59,507
Provisions	C.38	5,795	1,681
Lease liabilities		8	40
Derivatives	24	5,594	22,546
Other payables	C.39	51,176	43,954
Total current liabilities		84,937	136,891
Net current assets		270,378	106,881
Non-current liabilities			
Employee benefits	C.40	19,163	58,626
Deferred tax liabilities	C.35	11,687	–
Lease liabilities		1,806	1,841
Long-term loans to Group undertakings		313	–
Derivatives	24	355	41,102
Total non-current liabilities		33,324	101,569
Total assets less total liabilities		796,307	589,209
Equity			
Share capital	C.41	14,558	14,558
Share premium		42	42
Own shares held	25	(404)	(404)
Cash flow hedging reserve	25	11,345	(30,455)
Retained earnings		770,262	605,137
Other reserve	25	504	331
Total equity		796,307	589,209

The Company reported a profit for the financial year ended 30 June 2021 of £149,434,000 (2020: £12,861,000).

These financial statements were approved by the Board of Directors on 21 October 2021 and were signed on its behalf by:

Sir David McMurtry

Allen Roberts

Directors

Company statement of changes in equity

for the year ended 30 June 2021

	Share capital £'000	Share premium £'000	Own shares held £'000	Cash flow hedging reserve £'000	Retained earnings £'000	Other reserve £'000	Total £'000
Year ended 30 June 2020							
Balance at 1 July 2019	14,558	42	(404)	(42,401)	644,291	158	616,244
Profit for the year	-	-	-	-	12,861	-	12,861
Other comprehensive income and expense (net of tax)							
Remeasurement of defined benefit pension scheme liabilities	-	-	-	-	(18,537)	-	(18,537)
Changes in fair value of cash flow hedges	-	-	-	11,946	-	-	11,946
Total other comprehensive income and expense	-	-	-	11,946	(18,537)	-	(6,591)
Total comprehensive income and expense	-	-	-	11,946	(5,676)	-	6,270
Share-based payments charge	-	-	-	-	-	173	173
Dividends paid	-	-	-	-	(33,478)	-	(33,478)
Balance at 30 June 2020	14,558	42	(404)	(30,455)	605,137	331	589,209
Year ended 30 June 2021							
Profit for the year	-	-	-	-	149,434	-	149,434
Other comprehensive income and expense (net of tax)							
Remeasurement of defined benefit pension scheme liabilities	-	-	-	-	25,880	-	25,880
Changes in fair value of cash flow hedges	-	-	-	41,800	-	-	41,800
Total other comprehensive income and expense	-	-	-	41,800	25,880	-	67,680
Total comprehensive income and expense	-	-	-	41,800	175,314	-	217,114
Share-based payments charge	-	-	-	-	-	173	173
Dividends paid	-	-	-	-	(10,189)	-	(10,189)
Balance at 30 June 2021	14,558	42	(404)	11,345	770,262	504	796,307

Notes to the Company financial statements

C.30. Accounting policies

The following accounting policies have been applied consistently in dealing with items which are considered material in relation to the financial statements of the Company.

Basis of preparation

The financial statements were prepared in accordance with Financial Reporting Standard 101 'Reduced Disclosure Framework' (FRS 101). In preparing these financial statements, the Company applies the recognition, measurement and disclosure requirements of International Financial Reporting Standards as adopted by the EU (adopted IFRS), but makes amendments where necessary in order to comply with the Companies Act 2006.

The Company has applied the exemptions available under FRS 101 in respect of the following disclosures:

- a cash flow statement and related notes;
- comparative period reconciliations for share capital, tangible fixed assets and intangible fixed assets;
- disclosures in respect of transactions with wholly-owned subsidiaries;
- disclosures in respect of capital management;
- the effects of new but not yet effective IFRS; and
- disclosures in respect of the compensation of key management personnel.

As the consolidated financial statements of the Company include the equivalent disclosures, the Company has also taken the exemptions under FRS 101 available in respect of certain disclosures required by IFRS 13 'Fair Value Measurement' and the disclosures required by IFRS 7 'Financial Instruments: Disclosures'.

The financial statements have been prepared on the historical cost basis, except for the fair value of financial instruments. Historical cost is based on the fair value of the consideration given in exchange for the assets. The principal accounting policies are set out below.

Under section 408 of the Companies Act 2006 the Company is exempt from the requirement to present its own profit and loss account.

Critical accounting judgements and estimation uncertainties

The areas of key estimation uncertainty and critical accounting judgement that have a significant risk of causing a material adjustment to the carrying amount of assets and liabilities in the next financial year for the Company are consistent with those of the Group, as summarised on page 113.

Going concern

In preparing these financial statements, the Directors have adopted the going concern basis. The decision to adopt the going concern basis was made as part of the assessment of the Group's going concern status, details of which are set out on pages 113–114.

Having considered the impact on the Company of the same factors set out on pages 113–114, and the Company's business model, risk management and principal risks, and significant financial resources and cash balances, the Directors have a reasonable expectation that the Company will be able to continue in operation and meet its liabilities as they fall due over the period to 31 October 2022. Accordingly, they continue to adopt the going concern basis in preparing these financial statements.

Investments

Investments in subsidiary and associated undertakings are stated at cost less any provision for permanent impairment losses.

Property, plant and equipment, and depreciation

Property, plant and equipment assets are stated at cost less accumulated depreciation. Depreciation is provided to write off the cost of assets less their estimated residual value on a straight-line basis over their estimated useful economic lives as follows:

- freehold buildings, 50 years;
- plant and equipment, 3 to 25 years;
- motor vehicles, 3 to 4 years; and
- no depreciation is provided on freehold land.

Inventories

Inventories are valued at the lower of actual cost (on a FIFO basis) and net realisable value. Cost comprises direct materials and labour plus overheads applicable to the stage of manufacture reached.

Research and development

Expenditure on research activities is recognised in the income statement as an expense as incurred. Expenditure on development activities is capitalised if the product or process is technically and commercially feasible and the Company intends and has the technical ability and sufficient resources to complete development, future economic benefits are probable and the Company can measure reliably the expenditure attributable to the intangible asset during its development.

C.30. Accounting policies (continued)

Taxation

The charge for taxation is based on the Company's profit for the year. Deferred tax is provided on temporary differences between the carrying amounts of assets and liabilities for financial reporting purposes and the amounts used for taxation purposes.

Deferred tax assets are recognised to the extent that it is regarded as probable that they will be recovered.

Employee benefits

The Company operated a contributory pension scheme, of the defined benefit type up to 5 April 2007, after which this scheme was closed for future accruals to existing members and was closed to new members. Since 5 April 2007, the Company has operated a defined contribution scheme.

The scheme is administered by trustees who are independent of the Company finances.

Pension scheme assets in the defined benefit scheme are measured at fair value using market value. Pension scheme liabilities are measured using a projected unit method and discounted at the current rate of return on a high-quality corporate bond of equivalent term and currency to the liability. The expected return on the scheme's assets and the interest on the scheme's liabilities arising from the passage of time are included in other finance income.

The pension scheme's surplus, to the extent that it is considered recoverable, or deficit is recognised in full and presented on the face of the balance sheet. Where a guarantee is in place in relation to a pension scheme deficit, liabilities are reported in accordance with IFRIC 14. To the extent that contributions payable will not be available as a refund after they are paid into the plan, a liability is recognised at the point the obligation arises, which is the point at which the minimum funding guarantee is agreed.

Accruals are made for holiday pay, based on a calculation of the number of days' holiday earned during the year, but not yet taken and also for performance bonuses, if applicable.

Derivative financial instruments

In accordance with its treasury policy, the Company does not hold or issue derivative financial instruments for speculative purposes.

The Company uses forward exchange contracts to hedge its exposure to foreign exchange risk arising from operational and financing activities. Forward exchange contracts are recognised at fair value, being the estimated amount that the Company would pay or receive to terminate them at the balance sheet date based on prevailing foreign currency rates. Changes in the fair value of foreign currency derivatives which are designated and effective as hedges of future cash flows are recognised in Other comprehensive income and in the currency hedging reserve, and subsequently transferred to the carrying amount of the hedged item or the income statement. The ineffective part of any gain or loss is recognised in the income statement immediately.

Other financial instruments

Loans to associates and joint ventures are initially recognised at fair value and are subsequently held at amortised cost.

Loans to Group undertakings are initially recognised at fair value and are subsequently held at amortised cost using the effective interest rate method. Where such intercompany loans are repayable on demand the Company determines whether any impairment provision is required by assessing the company's ability to repay the loan. Where it is determined that a recipient company does not have the capacity to repay the loan at the balance sheet date, or the loan is not repayable on demand, an expected credit loss model is used to calculate the impairment provision required.

Trade and other current receivables are initially recognised at fair value and are subsequently held at amortised cost less any provision for bad and doubtful debts. Trade and other current payables are initially recognised at fair value and are subsequently held at amortised cost.

Warranty on the sale of products

The Company provides a warranty from the date of purchase, except for those products that are installed by the Company where the warranty starts from the date of completion of the installation. This is typically for a 12-month period, although up to three years is given for a small number of products. A warranty provision is included in the accounts, which is calculated on the basis of historical returns and internal quality reports.

Foreign currencies

Transactions in foreign currencies are translated at the rate of exchange prevailing at the date of the transaction. Monetary assets and liabilities denominated in foreign currencies at the balance sheet date are translated into Sterling at the foreign exchange rate prevailing at that date. Foreign exchange differences arising on such translation are recognised in the income statement.

Notes to the Company financial statements continued

C.31. Property, plant and equipment

Year ended 30 June 2021	Freehold land and buildings £'000	Plant and equipment £'000	Motor vehicles £'000	Assets in the course of construction £'000	Total £'000
Cost					
At 1 July 2020	112,484	181,638	3,952	3,860	301,934
Additions	230	3,942	–	2,643	6,815
Transfers	30	1,453	–	(1,483)	–
Disposals	–	(3,396)	(370)	–	(3,766)
At 30 June 2021	112,744	183,637	3,582	5,020	304,983
Depreciation					
At 1 July 2020	20,421	133,969	3,225	–	157,615
Charge for the year	2,079	12,459	341	–	14,879
Released on disposals	–	(3,253)	(349)	–	(3,602)
At 30 June 2021	22,500	143,175	3,217	–	168,892
Net book value					
At 30 June 2021	90,244	40,462	365	5,020	136,091
At 30 June 2020	92,063	47,669	727	3,860	144,319

At 30 June 2021, properties with a net book value of £81,769,000 (2020: £83,200,000) were subject to a fixed charge to secure the UK defined benefit pension scheme liabilities. See note 22 for additional information.

Additions to assets in the course of construction comprise:

	2021 £'000	2020 £'000
Freehold land and buildings	220	10,452
Plant and equipment	2,423	5,767
	2,643	16,219

C.32. Intangible assets

Year ended 30 June 2021	Goodwill £'000	Internally generated development costs £'000	Software licences and intellectual property £'000	Total £'000
Cost				
At 1 July 2020	9,305	162,398	25,224	196,927
Additions	–	9,628	2,957	12,585
At 30 June 2021	9,305	172,026	28,181	209,512
Depreciation				
At 1 July 2020	9,305	140,786	19,465	169,556
Charge for the year	–	8,480	1,156	9,636
Impairment	–	1,092	–	1,092
At 30 June 2021	9,305	150,358	20,621	180,284
Net book value				
At 30 June 2021	–	21,668	7,560	29,228
At 30 June 2020	–	21,612	5,759	27,371

See note 12 for further detail on impairments in the year.

C.33. Investments in subsidiaries

	2021 £'000	2020 £'000
Balance at the beginning of the year	288,548	288,548
Additions	–	–
Impairment	–	–
Balance at the end of the year	288,548	288,548

Details of the Company's subsidiaries are given in note C.44.

C.34. Investments in associates and joint ventures

Movements during the year were:

	2021 £'000	2020 £'000
Balance at the beginning of the year	2,999	1,468
Additions	749	4,299
Impairment	(2,295)	(2,768)
Balance at the end of the year	1,453	2,999

Details of the Company's associates and joint ventures are given in note C.45.

C.35. Deferred tax

Balances at the end of the year were:

	2021			2020		
	Assets £'000	Liabilities £'000	Net £'000	Assets £'000	Liabilities £'000	Net £'000
Property, plant and equipment	–	(14,295)	(14,295)	–	(9,787)	(9,787)
Intangible assets	–	(1,986)	(1,986)	–	(693)	(693)
Defined benefit pension scheme	3,877	–	3,877	11,139	–	11,139
Derivatives	–	(2,930)	(2,930)	6,344	–	6,344
Losses	3,299	–	3,299	11,225	–	11,225
Other	348	–	348	281	–	281
Balance at the end of the year	7,524	(19,211)	(11,687)	28,989	(10,480)	18,509

Deferred tax assets and liabilities are offset where there is a legally enforceable right of offset and there is an intention to net settle the balances. After taking these offsets into account, the net position of £11,687,000 liability (2020: £18,509,000 asset) is presented as a deferred tax liability in the Company's balance sheet. Where deferred tax assets are recognised, the Directors are of the opinion, based on recent and forecast trading, that the level of profits in current and future years make it more likely than not that these assets will be recovered.

Movements during the year were:

	2021 £'000	2020 £'000
Balance at the beginning of the year	18,509	5,037
Movements during the year	(30,196)	13,472
Balance at the end of the year	(11,687)	18,509

C.36. Inventories

An analysis of inventories at the end of the year was:

	2021 £'000	2020 £'000
Raw materials	28,463	24,257
Work in progress	21,406	17,934
Finished goods	18,593	18,122
Balance at the end of the year	68,462	60,313

Notes to the Company financial statements continued

C.37. Trade receivables

An analysis of trade receivables at the end of the year was:

	2021 £'000	2020 £'000
Trade receivables	46	179
Amounts owed by Group undertakings	68,263	63,344
Balance at the end of the year	68,309	63,523

C.38. Provisions

Provisions comprised:

	2021 £'000	2020 £'000
Warranty provision	5,795	1,681

Movements during the year were:

	2021 £'000	2020 £'000
Balance at the beginning of the year	1,681	2,382
Created in the year	5,881	1,772
Used in the year	(1,767)	(2,473)
	4,114	(701)
Balance at the end of the year	5,795	1,681

The warranty provision has been calculated on the basis of historical return-in-warranty information and other quality reports. It is expected that most of this expenditure will be incurred in the next financial year and all expenditure will be incurred within three years of the balance sheet date.

C.39. Other payables

An analysis of other payables due within one year at the end of the year was:

	2021 £'000	2020 £'000
Amounts owed to Group undertakings	28,384	32,480
Amounts owed to associated undertakings and joint ventures	130	297
Other taxes and social security	3,235	2,460
Other creditors and accruals	19,427	8,717
Balance at the end of the year	51,176	43,954

Other creditors and accruals includes £8,361,000 (2020: £nil) relating to performance bonus accruals.

C.40. Employee benefits

The Company operated a defined benefit pension scheme, which, at 5 April 2007, ceased any future accrual for current members and was closed to new members. Employees of the Company are now covered by a defined contribution scheme. See note 22 regarding details of charges relating to the UK defined benefit pension scheme liabilities.

The total pension cost of the Company for the year was £13,768,000 (2020: £15,289,000), of which £111,000 (2020: £136,000) related to Directors. The latest full actuarial valuation of the scheme was carried out at 30 September 2018 and updated to 30 June 2021 by a qualified independent actuary.

The major assumptions used by the actuary for the scheme were:

	30 June 2021	30 June 2020
Rate of increase in pension payments	3.10%	2.80%
Discount rate	1.85%	1.50%
Inflation rate (RPI)	3.20%	2.80%
Inflation rate (CPI)	2.20%	2.20%
Retirement age	64	64

The mortality assumption used for 2021 is the S2PxA base tables and CMI 2020 model, with long-term improvements of 1% per annum. Adjustments have been made to both the core base tables and CMI 2020 model to allow for the scheme's membership profile and best estimate assumptions of future mortality improvements. The weighted average duration of the defined benefit scheme obligation is around 23 years. See note 22 for further details of mortality assumptions and sensitivities.

C.40. Employee benefits (continued)

The assets and liabilities in the scheme were:

	30 June 2021 £'000	% of total assets	30 June 2020 £'000	% of total assets
Market value of assets:				
Equities	127,456	62	101,694	62
Multi-asset fund	60,220	29	52,286	32
Credit and fixed income funds	10,758	5	5,708	4
Index linked gilts	1,843	1	1,929	1
Cash and other	4,682	3	1,323	1
	204,959	100	162,940	100
Actuarial value of liabilities	(224,122)	–	(221,566)	–
Deficit in the scheme	(19,163)	–	(58,626)	–
Deferred tax thereon	3,877	–	11,139	–

All equities have quoted prices in active markets in the UK, North America, Europe, Asia Pacific, Japan and emerging markets.

The movements in the scheme were:

	Assets £'000	Liabilities £'000	Total £'000
Year ended 30 June 2021			
Deficit in scheme at the beginning of the year	162,940	(221,566)	(58,626)
Contributions	8,702	–	8,702
Interest on pension scheme	2,471	(3,286)	(815)
Remeasurement loss from GMP equalisation	–	(78)	(78)
Remeasurement gain/(loss) under IAS 19, the asset ceiling and IFRIC 14	35,970	(4,316)	31,654
Benefits paid	(5,124)	5,124	–
Deficit in scheme at the end of the year	204,959	(224,122)	(19,163)
Year ended 30 June 2020			
Deficit in scheme at the beginning of the year	158,692	(203,431)	(44,739)
Contributions	11,005	–	11,005
Interest on pension scheme	3,703	(4,605)	(902)
Remeasurement loss under IAS 19	(4,031)	(19,959)	(23,990)
Benefits paid	(6,429)	6,429	–
Deficit in scheme at the end of the year	162,940	(221,566)	(58,626)

The analysis of the amount recognised in Other comprehensive income and expense was:

	2021 £'000	2020 £'000
Actuarial gain/(loss) arising from:		
Changes in demographic assumptions	(2,839)	(656)
Changes in financial assumptions	4,045	(20,951)
Experience adjustment	2,621	1,648
Adjustment related to the application of revaluation and late retirement factors	14,300	–
Return on plan assets excluding interest income	35,970	(4,031)
Adjustment for the asset ceiling	(3,280)	–
Adjustment to liabilities for IFRIC 14	(19,163)	–
Total recognised in the Other comprehensive income and expense	31,654	(23,990)

C.41. Share capital

	2021 £'000	2020 £'000
Allotted, called-up and fully paid 72,788,543 ordinary shares of 20p each	14,558	14,558

The ordinary shares are the only class of share in the Company. Holders of ordinary shares are entitled to vote at general meetings of the Company and receive dividends as declared. The Articles of Association of the Company do not contain any restrictions on the transfer of shares nor on voting rights.

Notes to the Company financial statements continued

C.42. Related parties

During the year, related parties, these being the Group's associates and joint ventures (see note 13), had the following transactions and balances with the Company:

	Joint ventures		Associate	
	2021 £'000	2020 £'000	2021 £'000	2020 £'000
Purchased goods and services from the Company during the year	99	48	–	–
Sold goods and services to the Company during the year	3,618	1,917	–	–
Paid dividends to the Company during the year	–	100	–	–
Amounts owed by the Company at the year end	130	297	–	–
Loans owed to the Company at the year end	598	955	–	2,500

C.43. Capital commitments

Capital commitments at the end of the year, for which no provision has been made in the financial statements, were:

	2021 £'000	2020 £'000
Authorised and committed	2,555	5,357

C.44. Subsidiary undertakings

The following are the subsidiary undertakings of Renishaw plc as at 30 June 2021, all of which are wholly-owned and held by a subsidiary undertaking, unless otherwise stated. The country in which each subsidiary has its registered/principal office is its domicile and country of incorporation. The accounting year-end for each subsidiary undertaking is 30 June unless otherwise stated. The shareholdings in all the subsidiary undertakings are in the ordinary share capital of those undertakings. The principal activities for all the subsidiary undertakings are those of the Company, as set out in the Other statutory and regulatory disclosures on page 94, except as indicated below:

^D Dormant company [^] 31 December year end

^H Holding company [†] Ordinary-A shares

^T Travel agency [‡] Ordinary-C shares

* 31 March year end

Company	Registered Office
Owned by Renishaw plc	
MTT Investments Limited ^D	
Renishaw Advanced Materials Limited ^D	
Renishaw International Limited ^H	
Renishaw Medical Limited ^D	
Renishaw PT Limited ^D	New Mills, Wotton-under-Edge, Gloucestershire, GL12 8JR United Kingdom
Renishaw Software Limited ^D	
Renishaw Transducer Systems Limited ^D	
Renishaw UK Sales Limited	
Wotton Travel Limited ^T	
Measurement Devices Limited ^D	
Renishaw Diagnostics Limited ^{†‡} (92.4%)	Research Park North, Riccarton, Edinburgh, Scotland, EH14 4AP United Kingdom
Renishaw Tehnicni Inženiring d.o.o.	4th Floor, Faculty of Electrical Engineering, University of Ljubljana, Tržaška cesta 25, Ljubljana, 1000 Slovenia
Renishaw Neuro Solutions Limited	Wotton Road, Charfield, Wotton-under-Edge, Gloucestershire, GL12 8SP United Kingdom

C.44. Subsidiary undertakings (continued)

Company	Registered Office
Owned by MTT Investments Limited	
MTT Technologies Limited ^p	New Mills, Wotton-under-Edge, Gloucestershire, GL12 8JR United Kingdom
Owned by Renishaw International Limited	
itp GmbH	Rathausstraße 75-79, 66333, Völklingen Germany
OOO Renishaw [^]	Kantemirovskaya Ulitsa, 58, 115477, Moskva, Russian Federation
Renishaw (Austria) GmbH	Industriestraße 9, Top 4.5, 2353, Guntramsdorf Austria
Renishaw (Canada) Limited	2196 Dunwin Drive, Mississauga, Ontario, L5L 1C7 Canada
Renishaw (Hong Kong) Limited	Ever Gain Plaza Tower 2, 28/F, 88 Container Port Road, Kwai Chung Hong Kong
Renishaw (Ireland) DAC	Swords Business Park, Mountgorry, Swords, County Dublin, K67 FX67 Ireland
Renishaw (Israel) Limited	HaTnufa Street 3, Kraytek Building, PO Box 4, Yokne'am Illit, 2069204 Israel
Renishaw (Korea) Limited	RM#1314, Woolim e-Biz Center, 28 Digital-ro 33-gil, Guro-gu, Seoul Republic of Korea
Renishaw AB	Biskop Henriks väg 2, 176 76, Järfälla Sweden
Renishaw AG	Stachelhofstrasse 2, 8854, Siebnen, Schübelbach Switzerland
Renishaw ApS	c/o Azets Insight A/S, Lyskær 3CD, Lyskær 3, 2730, Herlev Denmark
Renishaw Benelux BV	Nikkelstraat 3, 4823 AE, Breda Netherlands
Renishaw GmbH (5.1% owned by Renishaw plc)	Karl-Benz Straße 12, 72124, Pliezhausen Germany
Renishaw Healthcare, Inc.	c/o C T Corporation System (Chicago), 208 South LaSalle Street, Suite 814, Cook County, Chicago IL 60604 United States
Renishaw Hungary Kft	Gyár utca 2, Budaörs, 2040 Hungary
Renishaw Ibérica S.A.U.	Gavà Park, Carrer de la Recerca, 7, Gavà, 08850, Barcelona Spain
Renishaw K.K.	4 Chome-29-8 Yotsuya, Shinjuku-ku, Tokyo, 160-0004 Japan
Renishaw Latino Americana Ltda. [^]	Calçada dos Cravos, 141, Alphaville Comercial, Barueri, São Paulo, 06453-053 Brazil
Renishaw Metrology Systems Limited*	S.No.283, Hissa no.2, S.No.284, Hissa no.2 & 3A, Rasoni Industrial Estate, Village Mann, Taluka Mulshi, Pune, 411057 India
Renishaw México S. de R.L. de C.V. [^] (0.001% owned by Renishaw, Inc.)	Iridium 5004, Parque Industrial Milenium, Apodoca, Nuevo León, 66600 Mexico

Notes to the Company financial statements continued

C.44. Subsidiary undertakings (continued)

Company	Registered Office
Renishaw Oceania Pty Limited	c/o KPMG, Tower Two, Collins Square, 727 Collins Street, Docklands VIC 3008 Australia
Renishaw Oy	c/o WaBuCo Oy, Energiakuja 3, Helsinki, 00180 Finland
Renishaw S.A.S.	15 Rue Albert Einstein, 77420, Champs-sur-Marne France
Renishaw S.p.A.	Via dei Prati 5, 10044 Pianezza, Torino Italy
Renishaw s.r.o.	Olomoucká 1164/85, Brno-Černovice, Brno, 627 00 Czech Republic
Renishaw Sp. z o.o.	ul. Osmańska 12, 02-823, Warszawa Poland
Renishaw SRL (0.1% owned by Renishaw UK Sales Limited)	Section A.2.13, 2nd Floor, Building A, Central Business Park, Calea Șerban Vodă 133, București, 040205 Romania
Renishaw Teknoloji Çözümleri LŞ	Turgut Özal Blv. No:193, Şerifali Mahallesi, Dudullu Osb, Ümraniye, İstanbul, 34775 Turkey
Renishaw US Holdings, Inc. ^H	c/o The Corporation Trust Company, 1209 Orange Street - Corporation Trust Center, New Castle County, Wilmington DE 19801 United States
Renishaw, Inc.	c/o C T Corporation System (Chicago), 208 South LaSalle Street, Suite 814, Cook County, Chicago IL 60604 United States
Owned by Renishaw (Hong Kong) Limited	
Renishaw (Malaysia) Sdn. Bhd.	Upper Penthouse, Wisma RKT, 2, Jalan Raja Abdullah, Chow Kit, 50300 Kuala Lumpur, Wilayah Persekutuan Malaysia
Renishaw (Shanghai) Management Company Limited [^]	288 Jiang Chang San Lu, Zhabei Qu, Shanghai, 20436 China
Renishaw (Shanghai) Trading Company Limited [^]	286 Jiang Chang San Lu, Zhabei Qu, Shanghai, 20436 China
Renishaw (Singapore) PTE Limited	988 Toa Payoh North, #06-07/08, 319002 Singapore
Renishaw (Taiwan) Inc	2F. No. 2, Jingke 7th Road, Nantun District, Taichung, 40852 Taiwan

C.44. Subsidiary undertakings (continued)

Company	Registered Office
Owned by Renishaw US Holdings, Inc.	
Renishaw Fixturing Solutions, LLC	c/o The Corporation Company, 40600 Ann Arbor Road East, Suite 201, Plymouth, MI, 48170 United States
Renishaw Properties, Inc.	c/o The Corporation Trust Company, 1209 Orange Street - Corporation Trust Center, New Castle County, Wilmington DE 19801 United States
Owned by Renishaw (Ireland) DAC	
Renishaw Mayfield SA	Stachelhofstrasse 2, 8854, Siebnen, Schübelbach Switzerland
Owned by Renishaw Mayfield SA	
Renishaw Mayfield SARL	31 Rue Ampère, 69680, Chassieu France
Owned by Renishaw Medical Limited	
Renishaw Medical AM Solutions Limited [†]	New Mills, Wotton-under-Edge, Gloucestershire, GL12 8JR United Kingdom

C.45. Associated undertakings and joint ventures

The following are the associated undertakings and joint ventures of Renishaw plc at 30 June 2021. The country in which each entity has its registered/principal office is its domicile and country of incorporation. The accounting year-end for each associate undertaking and joint venture is 30 June unless otherwise stated. The shareholdings in all the associated undertakings are in the ordinary share capital of those undertakings unless otherwise stated. The principal activities for all the associate undertakings and joint ventures are those of the Company, as set out in the Other statutory and regulatory disclosures on page 94.

[†] Ordinary-A shares

[^] 31 December year-end

Company	Registered Office
Owned by Renishaw plc	
HiETA Technologies Limited [†] (33.33%)	Bristol & Bath Science Park, Dirac Crescent, Emersons Green, Bristol, BS16 7FR United Kingdom
Metrology Software Products Limited (70%)	6F Greensfield Court, Alnwick, Northumberland, NE66 2DE United Kingdom
Owned by Renishaw International Limited	
RLS Merilna tehnika d.o.o. (50%)	Poslovna cona Žeje pri Komendi, Pod vrbami 2, Komenda, 1218 Slovenia

10 year financial record

Results	note 2021 £'000	note 2020 £'000	note 2019 £'000	note 2018 £'000	note 2017 £'000	note 2016 £'000	2015 £'000	note 2014 £'000	note 2013 £'000	2012 £'000
Overseas revenue	538,636	482,784	539,915	580,940	509,212	404,472	469,221	331,682	326,213	313,007
UK and Ireland revenue	26,923	27,431	34,044	30,567	27,595	22,752	25,499	23,816	20,668	18,885
Total revenue	565,559	510,215	573,959	611,507	536,807	427,224	494,720	355,498	346,881	331,892
Operating profit	118,568	51,700	93,711	143,045	108,733	86,952	143,924	70,388	79,071	83,188
Profit before tax	119,666	48,614	103,862	145,081	109,079	87,475	144,196	70,106	79,193	86,046
Taxation	23,611	11,547	16,557	20,942	12,819	14,880	22,850	10,720	15,046	17,008
Profit for the year	96,055	37,067	87,305	124,139	96,260	72,595	121,346	59,386	64,147	69,038
Capital employed	2021 £'000	2020 £'000	2019 £'000	2018 £'000	2017 £'000	2016 £'000	2015 £'000	2014 £'000	2013 £'000	2012 £'000
Share capital	14,558	14,558	14,558	14,558	14,558	14,558	14,558	14,558	14,558	14,558
Share premium	42	42	42	42	42	42	42	42	42	42
Reserves	688,730	532,264	568,677	533,994	429,214	366,785	413,918	336,163	262,119	227,799
Total equity	703,330	546,864	583,277	548,594	443,814	381,385	428,518	350,763	276,719	242,399
Statistics	2021	2020	2019	2018	2017	2016	2015	2014	2013	2012
Overseas revenue as a percentage of total revenue	95.2%	94.6%	94.1%	95.0%	94.9%	94.7%	94.8%	93.3%	94.0%	94.3%
Adjusted earnings per share	132.0p	51.0p	119.9p	170.5p	132.4p	100.4p	167.5p	82.3p	88.9p	95.6p
Proposed dividend	66.0p	0.0p	60.0p	60.0p	52.0p	48.0p	46.5p	41.2p	40.0p	38.5p

Note

The results and adjusted earnings per share for the years 2013, 2014, 2016, 2017, 2018, 2019, 2020 and 2021 exclude certain items. These were: 2013 – gain on deferred consideration settlement (£2.9m); 2014 – profit on disposal of shareholding in Delcam plc (£26.3m); and 2016 (£25.8m pre tax loss), 2017 (£8.0m pre tax gain), 2018 (£10.1m pre tax gain), 2019 (£6.1m pre tax gain), 2020 (£21.6m pre tax loss) and 2021 (£23.0m pre tax gain) – gains and losses from financial instruments not effective for cash flow hedging; 2020 – restructuring costs (£23.8m); and 2021 – third-party FSP costs (£3.2m). No years prior to 2016 have been adjusted for gains and/or losses from financial instruments not effective for cash flow hedging.

Additional information

Greenhouse gas emissions

	2021 ^b	2020 ^a	2019	2018	2017
Scope 1					
Gas Consumption	1,114.80	891.18	752.71	845.05	886.30
Owned Transport	1,836.50	2,286.72	2,694.60	2,463.30	2,241.78
Generator Diesel	20.01	39.51	37.99	34.95	28.67
Heating Oil	181.1	234.4	220.80	188.00	231.48
Fugitive Emissions	272.01	274.92	353.92	206.42	266.00
Out of scope (bio-fuel blend)	9.32	9.15	75.98	49.76	62.49
Total Scope 1 (tCO₂e)	3,424.42	3,726.73	4,060.02	3,737.72	3,654.23
Scope 2					
Purchased heat	11.52	8.85	5.98	13.29	4.50
Location-based					
Electricity	10,325.00	10,395.00	11,991.00	14,307.00	15,746.08
Total Scope 2 (tCO₂e)	10,336.52	10,403.85	11,996.98	14,320.29	15,750.57
Market-based					
Electricity	3,504.00	3,548.00	4,091.00	8,053.00	13,016.00
Total Scope 2 (tCO₂e)	3,515.52	3,556.85	4,096.98	8,066.29	13,020.50
Total statutory GHG emissions (tCO₂e)^{e, f}	6,939.94	7,283.58	8,157.00	11,804.00	16,674.73
Normalised statutory GHG emissions by revenue (Market-based tCO₂e/£m)^{e, f}	12.29	12.88	14.21	19.30	31.06
Scope 3					
Business travel	1,175.50	2,492.14	3,927.08	3,246.61	2,638.79
Product distribution	9,977.43	8,100.76	11,191.63	14,313.13	11,048.65
Raw material purchase ^g	1,334.92	1,333.92	2,265.05	1,492.79	1,517.53
Waste	247.69	111.47	111.47	71.00	67.40
Purchased services ^h	991.93	918.06	1,067.77	857.33	773.11
Employee commuting ^c	863.96	1,376.42	1,614.92	1,460.22	1,403.65
Homeworking ^d	2,017.51	936.73	–	–	–
Well-to-tank and transmission & distribution total	3,523.00	3,787.58	4,454.25	4,706.69	4,964.78
Out of scope (bio-fuel blend)	58.11	62.49	3.99	3.57	9.15
Total significant Scope 3 (tCO₂e)	20,131.93	19,057.07	24,632.17	26,147.77	22,413.91
Total GHG emissions (tCO₂e) market based^f	27,071.87	26,340.66	32,789.17	37,951.78	39,088.64
Normalised total GHG emissions by revenue (Market-based tCO₂e/£m)	47.95	46.57	57.12	62.06	72.82

^a 2020 figures have been restated due to improvements in our methodology, the addition of employee commuting and home working emissions and replacing the calculation used for the June 2020 data – see footnote b.

^b To facilitate the timely capture of information, this disclosure uses internally-reported data from July to May, and then the June data is given as an average of the previous three months. This will be restated next year if a material difference is seen.

^c This year we have modelled our employee commuting emissions, we have added a retrospective modelling of previous years for completeness of data.

^d Using the Homeworking Emissions Whitepaper, we have modelled our emissions for homeworking as a consequence of the COVID-19 pandemic. Prior to 2020 our homeworking emissions were not material, and so have not been included.

^e Statutory emissions are Scope 1 and 2 as required by the Companies Act 2006 (Strategic Report and Directors' Report) Regulations 2013 and are calculated using market-based methodology.

^f Renishaw uses the market-based method for calculating Scope 2 emissions for our total emissions to account for our efforts in generating and purchasing low-carbon energy. The location-based method is provided for disclosure only and all intensity, net and gross emissions shown are calculated using Scope 2 market-based method.

^g Raw material purchase figures are based on metal purchased by weight in the UK and office paper purchased across the UK. We are exploring how to increase the scope of this data to include other raw materials.

^h This is based on post and communications used within the UK and we are exploring how to increase the scope of this data to overseas operations in the future.

Additional information continued

Glossary

AGM	– Annual General Meeting	KW	– kilowatt – an amount of power equal to 1,000 watts
AM	– additive manufacturing (3D printing)	kWh	– kilowatt hour – an amount of energy equivalent to delivering 1 kW of power for an hour
APAC	– Asia Pacific	LR	– the FCA's Listing Rules
APMs	– alternative performance measures	M&A	– mergers and acquisitions
Brexit	– UK exit from the EU	MRO	– maintenance, repair and overhaul
Governance Code	– UK Corporate Governance Code 2018	NCI	– non-controlling interest
the Code	– Group Business Code	OCI	– other comprehensive income
Company	– Renishaw plc	P&L	– profit and loss account
CJRS	– Coronavirus Job Retention Scheme	PBT	– profit before tax
CMM	– co-ordinate measuring machine	PV	– photovoltaic
CNC	– computer numerically controlled	QA RA	– Quality Assurance and Regulatory Affairs
CPI	– consumer price index	RIS	– Regulatory Information Service
CR	– corporate responsibility	R&D	– research and development
CRM	– customer relationship management	RCC	– Renishaw Charities Committee
DEFRA	– Department for Environment, Food & Rural Affairs	RIDDOR	– Reporting of Injuries, Diseases and Dangerous Occurrences Regulations 2013
DTR	– the FCA's Disclosure Guidance and Transparency Rules	RNS	– Regulatory News Service
EBT	– Employee Benefit Trust	Scope 1	– Direct GHG emissions occur from sources that are owned or controlled by the company, for example, emissions from combustion in owned or controlled boilers, generators, vehicles, etc
EMEA	– Europe, Middle East and Africa	Scope 2	– GHG emissions from the generation of purchased electricity consumed by the company
EPS	– earnings per share	Scope 3	– indirect GHG emissions are a consequence of the activities of the company, but occur from sources not owned or controlled by the company
ERP	– enterprise resource planning	SEEG	– stereoelectroencephalography
EU	– European Union	SEM	– scanning electron microscopy
EUR	– Euro	STEM	– science, technology, engineering and mathematics
EY	– Ernst & Young LLP	tCO₂e	– tonnes of carbon dioxide equivalent
FCA	– Financial Conduct Authority	TCFD	– Task Force on Climate-related Financial Disclosures
FRC	– Financial Reporting Council	thinkstep	– thinkstep ltd
FX	– foreign exchange	TPR	– The Pensions Regulator
GBP	– Great British Pound or Pound Sterling	TSR	– total shareholder return, calculated as change in share price, assuming dividends are immediately reinvested
GHG	– greenhouse gas	WISE	– Women Integrity for Society Empowerment Organisation
GMP	– Guaranteed minimum pension	UK	– The United Kingdom of Great Britain and Northern Ireland
Group	– Renishaw plc and its subsidiaries	USD/US\$	– United States Dollar
H&S	– health and safety	US	– United States of America
HKD	– Hong Kong Dollar		
HQ	– headquarters		
HR	– human resources		
IEA	– International Energy Agency		
IFRS	– International Financial Reporting Standards		
IOSH	– Institution of Occupational Safety and Health		
IPCC	– Intergovernmental Panel on Climate Change		
JPY	– Japanese Yen		
KPI(s)	– key performance indicator(s)		

Trade marks

The following registered and unregistered trade marks, which are owned by Renishaw plc and its subsidiaries, appear throughout this Annual Report.

ATOM DX™	inVia™	neurolocate™	neuromate®	REVO®	Virsa™
FORTiS™	SPRINT™	RESOLUTE™			

Shareholder information

Ordinary shares

The Company has one class of ordinary 20p shares listed on the London Stock Exchange under code RSW, ISIN number GB0007323586.

Registrars

For all enquiries about shareholders' holdings, transfer and registration of shares and changes of name and address, contact the Company's registrars, Equiniti Limited:

Equiniti
Aspect House
Spencer Road
Lancing
West Sussex
BN99 6DA

Telephone: 0371 384 2169 (UK callers)
+44 121 415 7047
(international callers)

Website: www.shareview.co.uk

Calls are charged at the standard geographic rate. Calls outside the UK will be charged at the applicable international rate. Lines are open from 8:30am to 5:30pm (UK time), Monday to Friday (excluding English and Welsh public holidays).

AGM

The 2021 AGM will be held on Wednesday 24 November 2021 at the Company's headquarters at New Mills, Wotton-under-Edge, Gloucestershire, GL12 8JR at 10am. Further details can be found in the Notice of Meeting which is set out in a separate circular to shareholders. Shareholders holding shares in the Company through a nominee service should arrange to be appointed as a corporate representative or a proxy in respect of their shareholding in order to attend and vote at the meeting.

Financial reports

The Annual Report and copies of previous financial reports are available at www.renishaw.com/investor.

The half-year results and the preliminary announcement of the full-year results are published on our website promptly after they have been released through a Regulatory Information Service.

Electronic communications

All shareholder communications, including the Company's Annual Report, are made available on the Renishaw website, and you may opt to receive email notifications informing you when shareholder communications are available to view and download rather than receiving paper copies through the post. Receiving communications electronically provides certain advantages to shareholders and Renishaw, including accessing documents more quickly, reducing our environmental impact and reducing the cost of printing and delivery of documents. If you would like to sign up for this service, visit Equiniti's Shareview Portfolio website. You may change the way you receive communications at any time by contacting Equiniti.

Dividend mandate

Shareholders can arrange to have their dividends paid directly into their bank or building society account by completing a bank mandate form. This is the most secure and efficient method of payment. A mandate form can be obtained from Equiniti or you will find one on your last dividend confirmation.

Financial calendar

Annual General Meeting

24 November 2021

Half year

31 December 2021

Half-year results

February 2022

Trading update

May 2022

Interim dividend (provisional)

Ex-div date 10 March 2022
Record date 11 March 2022
Payment date 11 April 2022

Final dividend

Ex-div date 28 October 2021
Record date 29 October 2021
Payment date 29 November 2021

Registration details and Company Secretary

General Counsel & Company Secretary

Jacqueline Conway

Registered office

New Mills
Wotton-under-Edge
Gloucestershire
GL12 8JR

Telephone: +44 (0)1453 524524
Email: companysecretary@renishaw.com
Website: www.renishaw.com/investor

Registered number

01106260 (England and Wales)

Auditor and corporate advisers

Auditor

Ernst & Young LLP

Solicitors

Norton Rose Fulbright LLP
Borges Salmon LLP

Corporate broker

UBS

Principal bankers

Lloyds Bank plc

Shareholder information continued

Shareholder profile

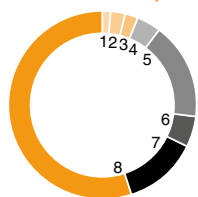

Shareholdings	%
1 1 – 5,000	1.42
2 5,001 – 25,000	2.69
3 25,001 – 50,000	2.12
4 50,001 – 100,000	4.23
5 100,001 – 500,000	16.57
6 500,001 – 1,000,000	5.27
7 1,000,001 – 3,000,000	12.83
8 more than 3,000,000	54.87

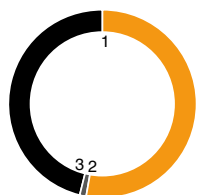

Shareholdings	%
1 Directors	52.84
2 Individuals	1.09
3 Institutions	46.07

Share fraud

We are aware some of our shareholders have received unsolicited calls or correspondence, offering to buy or sell their shares for a price in excess of the current market price. The callers can be very persuasive and extremely persistent and often have professional websites and telephone numbers to support their activities. These callers will sometimes imply a connection to Renishaw and provide incorrect or misleading information. Please be aware this is likely to be a scam – the safest thing to do is hang up.

You are advised to be wary of unsolicited advice or offers to buy shares.

See www.fca.org.uk/scamsmart/how-avoid-investment-scams for further advice.

Find out more or report suspected fraud to the FCA on their consumer helpline 0800 111 6768 (overseas callers dial +44 207 066 1000) or using the share fraud reporting form available at www.fca.org.uk/consumers/report-scam-us.

If you have already paid money to share fraudsters contact Action Fraud on 0300 123 2040 (overseas callers dial +44 300 123 2040) or their online fraud reporting tool at www.actionfraud.police.uk/reporting-fraud-and-cyber-crime.

Design and production by Radley Yeldar | ry.com

Printed by Park Communications on FSC® certified paper.

Park is an EMAS certified company and its Environmental Management System is certified to ISO 14001.

100% of the inks used are vegetable oil based, 95% of press chemicals are recycled for further use and, on average 99% of any waste associated with this production will be recycled.

This document is printed on Splendorgel, a paper which is certified by the FSC®.

The pulp used in this product is bleached using a totally chlorine free (TCF) process.



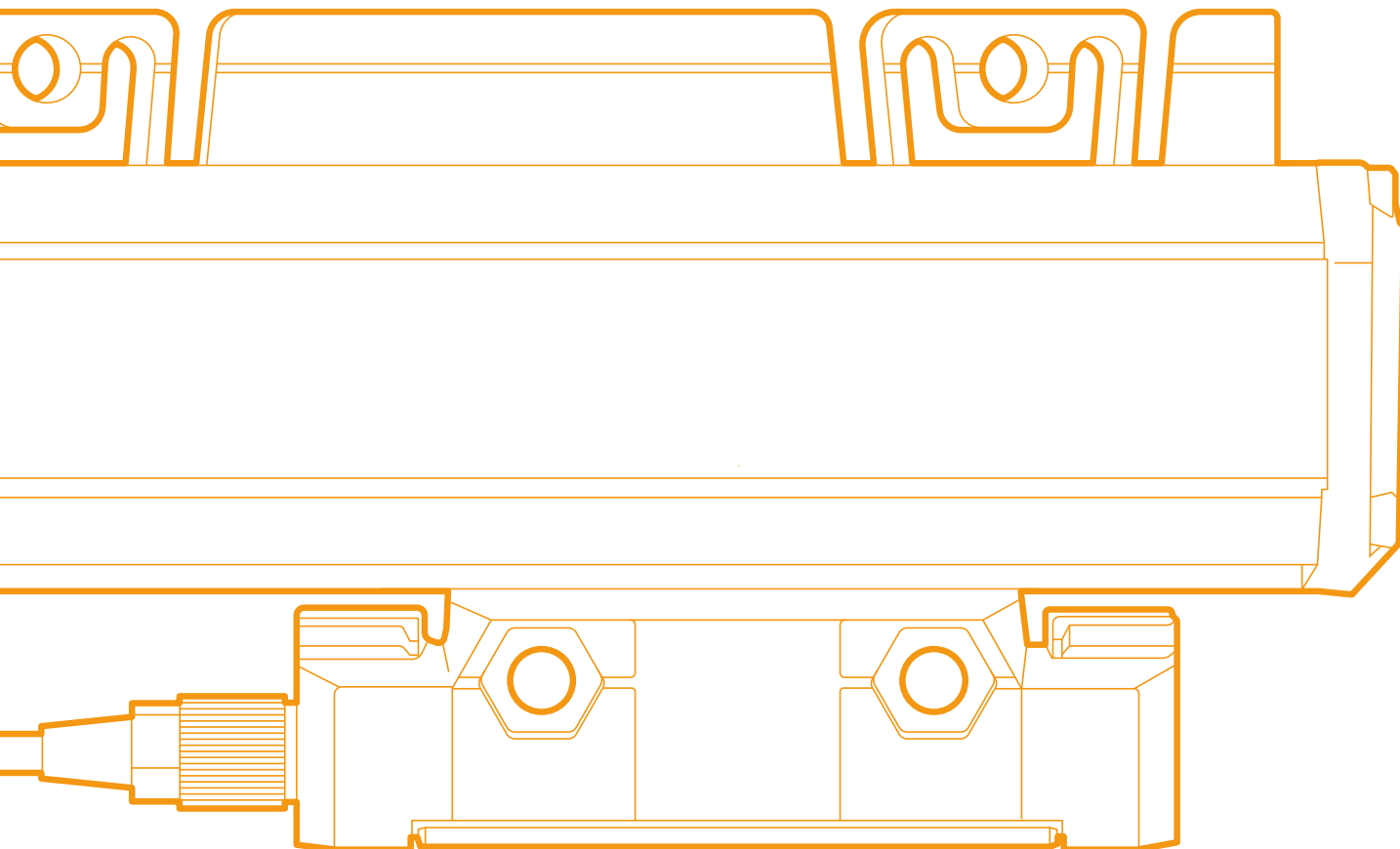

RENISHAW 
apply innovation™

Renishaw plc
New Mills, Wotton-under-Edge,
Gloucestershire GL12 8JR
United Kingdom
T: +44 (0) 1453 524524
F: +44 (0) 1453 524401
E: uk@renishaw.com

For more information visit:
www.renishaw.com